Automated Dispense System Service Guide



Version 5.1
May 18, 2018
Part No. 22290008G

for dispense system models:

DS Series (DS9000, DS9000IL, DS9100, DS9100IL)
MAX Series
MAX II Series

for use with:

FLOWare[®] Software v2.9J+

prepared by GPD Global[®] Documentation Dept.

GPD Global[®]
Precision Dispensing Systems

611 Hollingsworth Street
Grand Junction, CO, USA 81505
tel: +1.970.245-0408 • fax +1.970.245-9674
request@gpd-global.com • www.gpd-global.com

Copyright © 2018 GPD Global[®] • All Rights Reserved

Legal

Trademarks

- GPD Global® is a registered trademark of GPD Global, Inc.
- FLOWare® software is a registered trademark of GPD Global, Inc.
- ClearVu Vision™ and Taper-Lock™ are trademarks of GPD Global, Inc.
- Luer-Lok® is a registered trademark of Becton, Dickinson and Co.

Throughout this manual, trademarks are used. Rather than put a trademark symbol in every occurrence of a trademarked name, we state that we are using the names in an editorial fashion only and to the benefit of the trademark owner with no intention of infringement of the trademark.

Disclaimers

GPD Global® dispense systems are intended for the stated functions at the time of sale. GPD Global® is not liable for other uses.



IMPORTANT: Operation of a damaged machine may cause personal injury and invalidate the warranty

IMPORTANT:

L'utilisation d'une machine endommagée peut entraîner des blessures personnelles et invalider la garantie.

WICHTIG

Die Bedienung einer beschädigten Maschine kann zu Verletzungen des Bedieners sowie zur Ungültigkeit der Garantie führen.

IMPORTANTE

Il funzionamento di un'apparecchiatura danneggiata può causare lesioni personali e invalidare la garanzia.

IMPORTANTE

La utilización de una máquina averiada puede provocar lesiones e invalidar la garantía.

Table of Contents

Chapter 1: Introduction

Intended Audience & Equipment	1.1
Organization of Manual	1.1
Related Documents	1.2

Chapter 2: Installation

Prepare for Installation	2.1
Installation Procedure	2.2

Chapter 3: Start Up

Power On	3.1
Homing the System	3.3
Power Off	3.4

Chapter 4: Routine Maintenance

Safety Instructions	4.1
Schedules	4.2
Spare Part Kits	4.8
Tools & Equipment	4.9

Chapter 5: Periodic Operations

Adjustment Procedures	5.2
Calibration Procedures	5.46
Cleaning Procedures	5.58
Cleaning Pumps	5.71
Lubrication Procedures	5.76
Purging Procedures	5.78
Remove/Replace Procedures	5.80
Setup Procedures	5.90
Testing Procedures	5.111

Chapter 6: Troubleshooting

Safety Instructions	6.1
Indicators	6.2
Symptom/Problem/Action	6.2

Chapter 7: Specifications

MAX Series Specifications	7.2
DS Series Specifications	7.12
Weigh Scale	7.20

Chapter 8: Special Topics

Computer	8.2
Controllers	8.8
Conveyor	8.10
Facilities	8.17

Chapter 9: References

Legacy Controls & Operations	9.1
------------------------------------	-----

Index

Safety Notices

Warnings



WARNING
Hazardous voltage
equipment.
Voltage or current hazard
exists. An electric shock
may occur and fatal injury
may result.

HIGH VOLTAGE Due to the nature of the equipment, it should always be locked out during maintenance and service. Refer to *Energy Isolation Procedures* for details. No hazardous electrical work - Type 4 tasks - are to be performed on the equipment.



CAUTION
Hot surface.
The HOT SURFACE
may cause skin burns
or other injuries.
Avoid contact with
hot surfaces.

WARNING Heated surfaces are found within the system and are indicated by a warning icon. Do not touch these surfaces or materials surrounding them. Avoid all heated surfaces or burns and injury may occur.



WARNING
Crush hazard.
Keep hands clear.
Lockout/tagout
before servicing.



WARNING
Pinch Points.
Moving part can
crush or cut.
KEEP CLEAR.

WARNING Moving parts may trap or pinch hands and fingers.



WARNING Unintended release can occur most commonly during maintenance, as a result of operator error, when filling syringe material, or from fittings inside the cabinet. Refer to Dispense System User Guide and Dispense System Service Guide.

Larger unintended release can be caused when remote source of materials is not properly utilized. Contact manufacturer for more information. When the front shield is open, syringe pressure is zero (0).



WARNING Items that become solid waste include: dispense tubes and parts, filters, seals, and fittings. These items originate from the dispense pump, syringe, and external fill.



WARNING Recommended decontamination and decommissioning procedures:

- Some materials may be regulated wastes depending on the materials dispensed. Remove all contaminated parts and dispose of per MSDS / SDS instructions and local laws.
- Chemical Safety: Changes to the typical process chemistry or to the equipment could alter the anticipated environmental impact, change the risk of operating the equipment and possibly result in fire or destruction.

Precautions

Translated versions of the following safety precautions are used throughout this document and are listed together here:

Translations:

- [Consignes de sécurité](#)
- [Sicherheitsanweisungen](#)
- [Istruzioni di sicurezza](#)
- [Instrucciones de seguridad](#)



CAUTION: The protective earth ground connection symbol below identifies the machine's protective earth ground connection to a panel/chassis.



CAUTION: DO NOT override the safety package or else personal injury could result.



CAUTION: DO NOT open the safety shielding while a program is running or a safety violation message will appear and the program will abort.



IMPORTANT: Only qualified service or maintenance personnel should perform installation or maintenance procedures requiring access to the machine interior. Any screw-fastened panel is considered inaccessible to the operator.



OPERATOR SAFETY: GPD Global recommends you wear safety glasses whenever setting up, operating, or performing maintenance or troubleshooting procedures on the dispenser.



OPERATOR SAFETY: DO NOT operate the machine with the back hood open. Bolt the back hood shut before powering on the machine because there are no safety interlocks in that area to prevent access to moving parts.











OPERATOR SAFETY: If a conveyor is present, install barriers or signage in accordance with the applicable requirements to prevent access to the sides of the machine where (1) the conveyor rails protrude and (2) the cutouts in the safety shielding accommodate the conveyor.







CE SAFETY CERTIFICATION: DO NOT alter the machine in any way not specified in this document or CE safety certification will be void. Equipment is to be used only for its intended purpose.





Precaution Translations

Consignes de sécurité









- 
ATTENTION: Le symbole de la connexion de terre ci-dessous identifie une connexion de terre de la machine à un panneau/châssis.
 
- 
ATTENTION: NE PAS neutraliser le dispositifs de sécurité pour éviter des blessures corporelles.
- 
ATTENTION: NE PAS ouvrir l'écran de protection quand un programme est en cours d'exécution, sinon un message de violation de la sécurité apparaîtra et le programme sera interrompu.
- 
IMPORTANT: Seules des personnes qualifiées chargées de la réparation ou de l'entretien peuvent effectuer les procédures d'installation ou d'entretien exigeant l'accès à l'intérieur de la machine. Tout panneau vissé est considéré comme inaccessible.
- 
SÉCURITÉ DE L'OPÉRATEUR GPD Global recommande le port de lunettes de protection lors du montage, du fonctionnement, de l'entretien ou de la réparation du distributeur.
- 
SÉCURITÉ DE L'OPÉRATEUR NE PAS faire fonctionner la machine avec le capot arrière ouvert Verrouiller le capot arrière avant de mettre la machine en marche car il n'existe pas de dispositif de sécurité empêchant l'accès aux pièces mobiles.
- 
SÉCURITÉ DE L'OPÉRATEUR Si vous utilisez un convoyeur, installer des barrières ou des signaux conformément aux règlements en vigueur pour empêcher l'accès sur les côtés de la machine où (1) les rails du convoyeur font saillie et (2) les découpes de l'écran de sécurité permettent d'installer le convoyeur.
- 
CERTIFICATION SÉCURITÉ CE NE PAS modifier la machine d'une manière non spécifiée dans ce document au risque d'annuler la certification de sécurité CE. L'équipement doit être utilisé uniquement aux fins prévues.

Sicherheitsanweisungen









- 
VORSICHT! Das unten abgebildete Symbol der Erdungsschutzverbindung zeigt die Erdungsschutzverbindung der Maschine mit einer Abdeckung/Grundplatte an.
 
- 
VORSICHT! Setzen Sie NIEMALS die Sicherheitseinrichtungen ausser Kraft, es koennte Personenschaden entstehen.
- 
VORSICHT! Bei laufendem Programm dürfen Sie die Schutzabdeckung NICHT öffnen. Andernfalls wird ein Sicherheitsverstoß gemeldet und das Programm abgebrochen.
- 
WICHTIG Installationen, bei denen auf das Innere der Maschine zugegriffen werden mußm dürfen nur von qualifiziertem Fachpersonal ausgeführt werden. Mit Schrauben befestigte Abdeckungen dürfen vom Bediener grundsätzlich nicht entfernt werden.

-  **BETRIEBSSICHERHEIT** GPD Global recommends you wear safety glasses whenever setting up, operating, or performing maintenance or troubleshooting procedures on the dispenser.
-  **BETRIEBSSICHERHEIT** Die Maschine darf NICHT bedient werden, wenn die hintere Abdeckung offen ist Die hintere Abdeckung vor der Inbetriebnahme der Maschine festschrauben oder verbolzen, da in diesem Bereich die sich bewegenden Teile nicht durch eine Sicherheitssperre geschützt sind.
-  **BETRIEBSSICHERHEIT** An Fließbändern müssen gemäß den einschlägigen Bestimmungen Schutzschranken oder Warnungen angebracht werden, damit die Bereiche der Maschine, an denen (1) die Räder des Fließbandes heraustreten bzw. (2) die Sicherheitsabdeckung aufgrund der Form des Fließbandes eingeschnitten wurde, vor Zugriff geschützt sind.
-  **CE-SICHERHEITZERTIFIZIERUNG** NIEMALS Änderungen an der Maschine vornehmen, die in diesem Dokument nicht aufgeführt sind, da sonst die CE-Sicherheitszertifizierung ungültig wird. Die Anlage darf nur für den beabsichtigten Zweck benutzt werden.

Istruzioni di sicurezza

-  **ATTENZIONE** Il simbolo del collegamento della presa di terra di protezione ubicato in basso identifica il collegamento della presa di terra ad un pannello/tel-  aio.
-  **ATTENZIONE** NON aggirate le disposizioni sulla sicurezza, potrebbero verificarsi danni alle persone.
-  **ATTENZIONE** NON aprire la protezione di sicurezza durante l'esecuzione di un programma altrimenti apparirà un messaggio di violazione di sicurezza ed il programma verrà interrotto.
-  **IMPORTANT:** Solamente personale di servizio o di manutenzione deve eseguire le procedure di installazione o di manutenzione richieste per accedere all'interno dell'apparecchiatura. Qualsiasi pannello fissato con viti va considerato inaccessibile all'operatore.
-  **SICUREZZA DELL'OPERATORE** La GPD Global raccomanda l'uso di occhiali protettivi durante la preparazione, il funzionamento, l'esecuzione della manutenzione o le procedure di localizzazione dei guasti sull'erogatore.
-  **SICUREZZA DELL'OPERATORE** NON far funzionare l'apparecchiatura con la protezione posteriore aperta. Chiudere con bulloni la protezione posteriore prima di dare corrente all'apparecchiatura in quanto non vi sono dispositivi di bloccaggio di sicurezza in quella zona per impedire l'accesso a parti mobili.
-  **SICUREZZA DELL'OPERATORE** Se vi è un trasportatore, installare barriere o segnali come previsto dai requisiti applicabili allo scopo di impedire l'accesso ai lati dell'apparecchiatura dove (1) le guide del trasportatore sporgono e (2) gli interruttori nello schermo di sicurezza alloggiato il trasportatore.
-  **CE SAFETY CERTIFICATION:** NON alterare l'apparecchiatura in nessun caso a meno che non sia indicato da questo documento altrimenti la certificazione CE risulterà invalida. L'attrezzatura deve essere usata solo per lo scopo previsto.

Instrucciones de seguridad

-  **PRECAUCIÓN** El símbolo de conexión de seguridad a tierra indica que un panel o chasis de la máquina está conectado a tierra. 
-  **PRECAUCIÓN** NO saltarse el paquete de Seguridad, o alguna persona podría sufrir daños.
-  **PRECAUCIÓN** NO ABRA la protección de seguridad mientras se esté ejecutando un programa, si lo hace aparecerá un mensaje de violación de seguridad y se abortará el programa.
-  **IMPORTANTE** Los procedimientos de instalación y mantenimiento que requieren acceso al interior de la máquina sólo deben ser realizados por personal cualificado o técnicos de mantenimiento. Todo panel fijado por tornillos se considera vedado al usuario.
-  **SEGURIDAD DEL USUARIO** GPD Global recomienda el uso de gafas de seguridad al realizar procedimientos de configuración, utilización, mantenimiento o solución de fallos en el dosificador.
-  **SEGURIDAD DEL USUARIO** NO UTILICE la máquina con la cubierta posterior abierta. Para prevenir el acceso a las piezas móviles, trabe la cubierta posterior antes de encender la máquina, ya que esos componentes no tienen mecanismos de seguridad.
-  **SEGURIDAD DEL USUARIO** Si se utiliza un mecanismo transportador, instale barreras o letreros de señalización según sea necesario, para prevenir el acceso a los lados de la máquina, principalmente en lugares donde 1) los rieles sobresalen, y 2) en los bordes de los protectores, junto al mecanismo transportador.
-  **CERTIFICACIÓN DE SEGURIDAD DE LA CE** NO MODIFIQUE la máquina de ninguna manera que no esté específicamente indicada en este documento. De lo contrario, se anulará la certificación de seguridad de la CE. Sólo se debe usar el equipo para su finalidad específica.

Warranty

General Warranty. Subject to the remedy limitation and procedures set forth in the Section “Warranty Procedures and Remedy Limitations,” GPD Global warrants that the system will conform to the written description and specifications furnished to Buyer in GPD Global’s proposal and specified in the Buyer’s purchase order, and that it will be free from defects in materials and workmanship for a period of one (1) year. GPD Global will repair, or, at its option, replace any part which proves defective in the sole judgment of GPD Global within one (1) year of date of shipment/invoice. Separate manufacturers’ warranties may apply to components or subassemblies purchased from others and incorporated into the system. THIS WARRANTY IS EXPRESSLY IN LIEU OF ANY AND ALL OTHER WARRANTIES, EXPRESS OR IMPLIED, INCLUDING WARRANTIES OF MERCHANTABILITY OR FITNESS FOR A PARTICULAR PURPOSE.

Limitations. GPD Global reserves the right to refuse warranty replacement, where, in the sole opinion of GPD Global the defect is due to the use of incompatible materials or other damages from the result of improper use or neglect.

This warranty does not apply if the GPD Global product has been damaged by accident, abuse, or has been modified without the written permission of GPD Global.

Items considered replaceable or rendered unusable under normal wear and tear are not covered under the terms of this warranty. Such items include fuses, lights, filters, belts, etc.

Warranty Procedures and Remedy Limitations. The sole and exclusive remedy of the buyer in the event that the system or any components of the system do not conform to the express warranties stated in the Section “Warranties” shall be the replacement of the component or part. If on-site labor of GPD Global personnel is required to replace the non-warranted defective component, GPD Global reserves the right to invoice the Buyer for component cost, personnel compensation, travel expenses and all subsistence costs. GPD Global’s liability for a software error will be limited to the cost of correcting the software error and the replacement of any system components damaged as a result of the software error. In no event and under no circumstances shall GPD Global be liable for any incidental or consequential damages; its liability is limited to the cost of the defective part or parts, regardless of the legal theory of any such claim. As to any part claimed to be defective within one (1) year of date of shipment/invoice, Buyer will order a replacement part which will be invoiced in ordinary fashion. If the replaced part is returned to GPD Global by Buyer and found by GPD Global in its sole judgment to be defective, GPD Global will issue to Buyer a credit in the amount of the price of the replacement part. GPD Global’s acceptance of any parts so shipped to it shall not be deemed an admission that such parts are defective.

Specifications, descriptions, and all information contained in this manual are subject to change and/or correction without notice.

Although reasonable care has been exercised in the preparation of this manual to make it complete and accurate, this manual does not purport to cover all conceivable problems or applications pertaining to this machine.

1 Introduction

This manual is intended as an installation and routine maintenance procedural guide. This manual can also be used to familiarize yourself with the troubleshooting procedures and specification and spare parts information for both GPD Global automatic dispense lines - the MAX Series and the DS Series.

Intended Audience & Equipment

This manual is intended as an installation and service guide for Maintenance and Service personnel when working with the following standard models of GPD Global automatic dispense equipment.

The assumption is made here that you have read and are familiar with the contents of the *Dispense System User Guide*. An assigned Engineer should know all operating procedures and should be able to create and modify programs.

Organization of Manual

This manual is organized as follows:

- 1. Introduction* The intended audience for and systems addressed by this document, how information is organized within this document, and a listing of separate but related documents.
- 2. Installation* Guide to preparing an area for, unpacking, moving, leveling, and/or connecting a system.
- 3. Start Up* Overview to powering system on and off, safety package, and servo system homing process.
- 4. Routine Maintenance* Schedule of routine preventive maintenance procedures, plus instructions for using various mechanical and software test instruments required by some maintenance procedures.
- 5. Periodic Operations* Collection of detailed maintenance instructions categorized by purpose: adjustments, calibration, cleaning, lubrication, purging, removal or replacement, set up, and testing.
- 6. Troubleshooting* List of possible operating symptoms, problems, and solutions.
- 7. Specifications* Specifications for facilities, performance, capacities.
- 8. Special Topics* Detailed information beyond the routine scope of operations regarding the computer, conveyor, temperature controllers, system voltage changes, and needle/nozzle charts.

Related Documents

For additional information about the dispense system, refer to the following documents.

Associated Documents:

- *Dispense System User Guide* PN 22100079K
- *FLOware Software Guide* PN 22100080D
- *Kits & Parts for Dispensers & Related Equipment* PN 22290036

Reference Documents:

- *CMOS Set Up* PN 22100114-x
- *Dispenser Software Recovery* PN 22100109CD.29
- *FLOware Base Locations Reference Guide* PN 22100025
- *FLOware Messages Reference Guide* PN 22100026
- *FLOware Import/Export Data Reference Guide* PN 22100024
- *Mechanical Drawings* -
- *Electrical Schematics* -

2 Installation

Installation consists of two phases:

Phase I

Customer typically performs phase 1 of the installation:

1. Collecting the necessary information, tools, and equipment.
2. Preparing an area for the machine.
3. Unpacking, inspecting, and leveling the machine.
4. Installing and connecting cables and peripheral equipment.
5. Collecting the process test materials for use during the final installation phase.

Phase II

GPD Global personnel typically perform the second and final phases of installation:

1. Power up the machine.
2. Final set up.

Prepare for Installation

Machine Elements

Refer to the *Machine Overview* and *User Interface* sections of the *Dispense System User Guide* to familiarize yourself with the main elements, controls, and concepts of the GPD Global dispenser.

Facilities, Tools, & Equipment

Required

- Forklift (2 ton capacity)
- End wrench
- Air lines (capacity of 4 CFM @ 87 psi [113 l/min @ 600 kPa])
- Power cord plug

The equipment is provided with a main power inlet; main equipment over-current protection must be provided from the facility dedicated branch circuit. This branch circuit should be 15 amp and limited to 2kAIC current. 220-240 Volts AC, 50 or 60 HZ.

- Setup & Leveling Kit
- Product samples (for testing; dictated by process)
- Process materials (for testing; dictated by process)

The equipment is provided with a main power inlet; main equipment over-current protection must be provided from the facility dedicated branch circuit.

The short circuit current rating equipment is 2kAIC.

Recommended

The use of the following optional items is recommended:

- Spare Parts Kits for machine, heads, and devices
- GPD Tie Down Clamps (P/N 22201332)

Installation Procedure

These installation instructions are intended for use by qualified maintenance personnel.



IMPORTANT Install machine in accordance with applicable standards and regulations, and read all safety instructions.

IMPORTANT
Installer la machine conformément aux normes et règlements applicables et lire toutes les instructions de sécurité.

WICHTIG Installieren Sie die Maschine gemaess der zutreffenden Standards und Vorschriften und lesen Sie die Sicherheitsanweisungen.

IMPORTANTE Installate la macchina conformemente alle regole ed agli standard applicabili e leggete tutte le istruzioni sulla sicurezza.

IMPORTANTE
Instalar la máquina de acuerdo con los estándares y regulaciones aplicables. Y leerse todas las normas de seguridad.

Prepare Area

Prepare an area to meet machine specifications:

- [DS Series Specifications](#) (pg 7.12)
- [MAX Series Specifications](#) (pg 7.2)

Unpack & Inspect

1. With the following exception, carefully unpack the machine and any boxes accompanying it - use the packing slip to identify all items.



EXCEPTION Do NOT unpack the optional weigh scale (box marked “Weighing Module”). GPD Global personnel will perform the final installation of the weigh module; special attention is required when unpacking this delicate, precision device.



CAUTION For any delicate, precision item, such as the weigh scale, keep all original packaging for re-use in case you need to ship the device in the future. The weigh scale should only be transported in its original packaging.

2. Visually inspect the machine for any damage due to shipping. If any damage is observed, notify the carrier at once. Claims for damage must be made by the consignee to the carrier.



IMPORTANT Operation of a damaged machine may cause personal injury and invalidate the warranty.

IMPORTANT L'utilisation d'une machine endommagée peut entraîner des blessures personnelles et invalider la garantie.

WICHTIG Die Bedienung einer beschädigten Maschine kann zu Verletzungen des Bedieners sowie zur Ungültigkeit der Garantie führen.

IMPORTANTE Il funzionamento di un'apparecchiatura danneggiata può causare lesioni personali e invalidare la garanzia.

IMPORTANTE La utilización de una máquina averiada puede provocar lesiones e invalidar la garantía.

Position & Level Machine

Tie Downs

If the optional tie down clamps (P/N 22201332) are required, the machine may need to be leveled both before and after the tie down procedure. If tie down clamps are NOT required, skip to [Level Machine](#).

1. Prepare floor as needed using [Spacing & Locations](#) (pg 7.11).
2. Verify a minimum of 30 mm of the foot screw thread is exposed. There is no need to remove the foot.
3. Using a 5/16 allen wrench, remove bolt from tie down clamp.
4. Slide the tie down clamp onto the welded boss on foot.
5. Reinstall the bolt in tie down clamp.
6. Repeat the above steps for remaining tie down clamps.
7. Install customer-provided anchor bolts in tie down clamps to secure machine to floor.

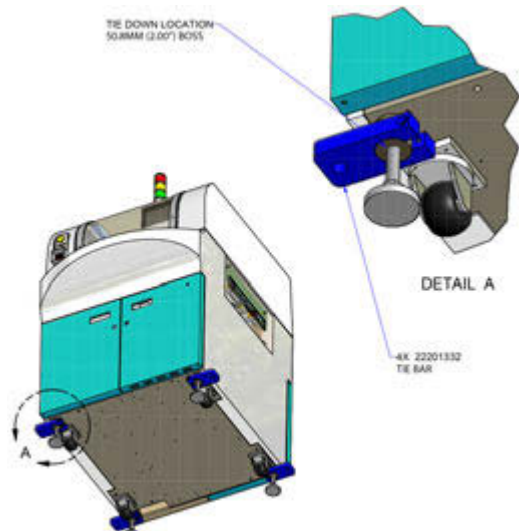

Level Machine

To move the machine into position and then align and level it:

1. Carefully position the machine in place with a forklift.
2. Choose one:
 - If the machine is NOT equipped with a conveyor, continue with step 3.
 - If the machine is equipped with a conveyor, adjust the machine laterally so the conveyor rails are aligned with both upstream/downstream conveyors so product can transfer smoothly.
3. Level the gantry:
 - a. Place a precision level on one of the X-axis linear rails.
 - b. As necessary, adjust machine leveling feet with an end wrench making any necessary adjustments to overall machine height.

NOTE: If the machine is equipped with a conveyor, be sure to maintain conveyor height and alignment settings so the exit end of the conveyor is within 1/32" (0.8 mm) of the downstream conveyor.

 - c. Repeat the two previous steps for the Y-axis linear rail.

Install System



IMPORTANT Do not turn on the machine or perform any steps in addition to the specified installation instructions — GPD Global personnel will perform the final installation steps and power on the machine.

IMPORTANT Ne pas mettre en marche la machine ou effectuer d'autres étapes que celles qui sont spécifiées dans les instructions d'installation - le personnel de GPD Global effectuera les dernières étapes de l'installation et activera la machine.

WICHTIG Schalten Sie die Maschine nicht ein und unternehmen Sie keine weiteren Schritte, als die in den Installationsanweisungen aufgeführten. GPD Global Personal wird die endgültige Installation durchführen und die Maschine hochfahren.

IMPORTANTE Non accendete la macchina e non fate nulla al di fuori di quanto specificato nelle istruzioni di installazione - Il personale GPD Global effettuerà le operazioni di installazione finale e accenderà la macchina.

IMPORTANTE No conectar la máquina ni realizar alguna operación posterior, que no esté acorde con las instrucciones específicas de instalación - El personal técnico de GPD Global realizará la instalación final y pondrá la máquina en marcha.

After the machine is aligned and leveled, perform the following steps:

1. Install the status light tower:
 - a. Insert the light tower into the hood and lock it in place with set screws.
 - b. Plug the light tower in under the hood.
2. Install the monitor and plug in its power and signal cables.
3. Plug in the track ball cable.
4. As needed, hook up ventilation per [Specifications](#) (pg 7.1).
5. Verify that the following has been done:
 - The main power switch is turned OFF.
 - All safety shields are CLOSED.
 - All hood(s) are CLOSED and SECURED.

~ continued ~

6. As applicable, connect the following items to the service panel:
- Printer cord (to serial or parallel port on rear panel)
 - Ethernet connections
 - SMEMA cables - if only the incoming connector is used, connect it to the downstream (left) port and terminate the upstream (right) port.
 - Camera cables

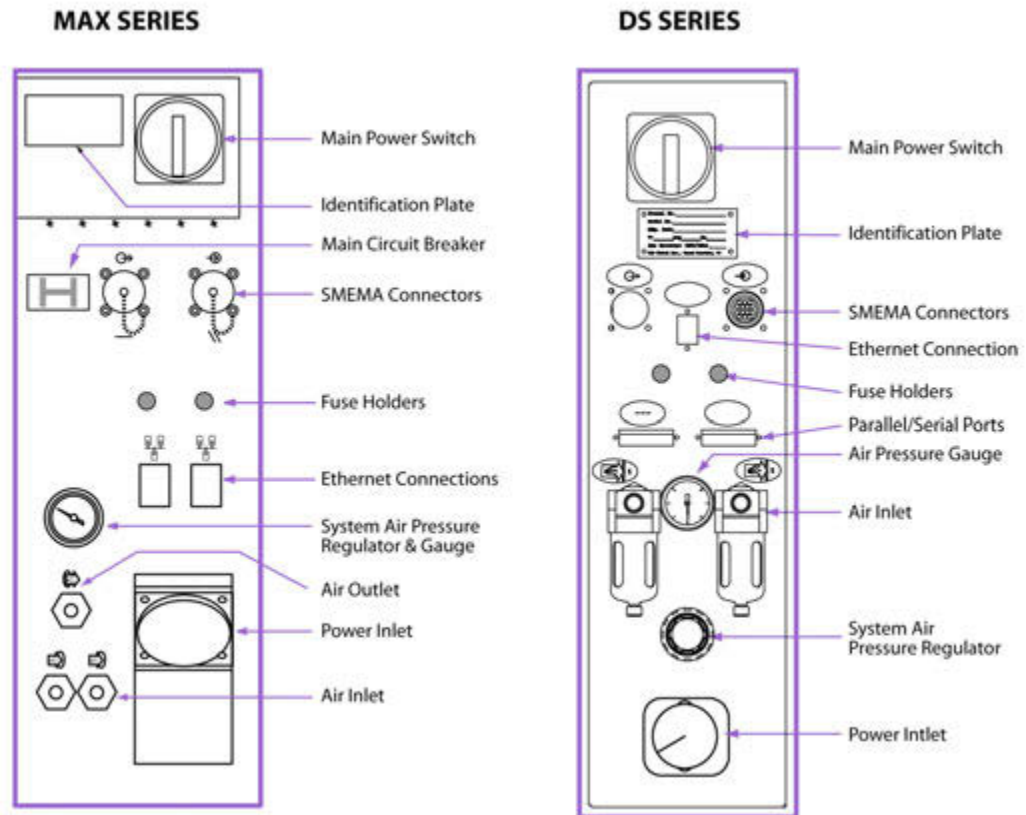

7. Connect and adjust the air pressure regulator on the rear panel per [Specifications](#) (pg 7.1).

~ continued ~

8. Per machine [Specifications](#) (pg 7.1) and your local electrical code, install an appropriate power plug on the machine power cable.

DO NOT power on the machine at this point.



IMPORTANT Do not turn on the machine or perform any steps in addition to the specified installation instructions — GPD Global personnel will perform the final installation steps and power on the machine.

IMPORTANT Ne pas mettre en marche la machine ou effectuer d'autres étapes que celles qui sont spécifiées dans les instructions d'installation - le personnel de GPD Global effectuera les dernières étapes de l'installation et activera la machine.	WICHTIG Schalten Sie die Maschine nicht ein und unternehmen Sie keine weiteren Schritte, als die in den Installationsanweisungen aufgefuehrten. GPD Global Personal wird die endgueltige Installation durchfuehren und die Maschine hochfahren.	IMPORTANTE Non accendete la macchina e non fate nulla al di fuori di quanto specificato nelle istruzioni di installazione - Il personale GPD Global effettuerà le operazioni di installazione finale e accenderà la macchina.	IMPORTANTE No conectar la máquina ni realizar alguna operación posterior, que no esté acorde con las instrucciones específicas de instalación - El personal técnico de GPD Global realizará la instalación final y pondrá la máquina en marcha.
---	--	--	--

9. Prepare for final installation and training to be performed by GPD Global personnel:
- Make sure the accessories and items that arrived with the machine are available for the installation process.
 - Make sure the dispensing materials and personnel dictated by your process (such as sample boards for testing, process materials, personnel, etc.) are available for training.

You have completed the preliminary dispenser installation steps. GPD Global personnel will perform the final installation steps including powering on the machine.

3 Start Up

This section is an overview of how to power the dispenser on and off, plus background information about the system safety package and servo system homing process.

For complete details about how to gain access to the control software, stop and resume machine operations, move the gantry in order to position the heads and camera, and run a program, refer to *Basic Operations* in the *Dispense System User Guide*.

Power On

To power on the dispenser:

IMPORTANT: Does your system use a **legacy control panel**? To find out, refer to [Legacy Controls & Operations](#) (pg 9.1) where alternative/legacy content is also available.

1. Read all [Safety Notices](#) and operating instructions before operating the machine, and observe the following safety notices at all times when the system is powered on.

Safety Package Circuit Description - The safety package uses interlock switches, positive guided relays, servo control relays, and a safety gate monitor. Use the table below for quantity of each item by dispenser model. For diagram details, refer to the Safety Package Circuit Diagrams in the *Mechanical & Electrical Reference* document.

Table 1: Quantities Used in Safety Package

Item	MAX Series	DS Series
Interlock switches	2	2
Positive guided relay for removal of power to motors	3	1
Additional relays for control of servo enable signals and reset	3	3
Safety gate monitor	1	1



CAUTION DO NOT override the safety package or else personal injury could result.

ATTENTION NE PAS neutraliser les dispositifs de sécurité pour éviter des blessures corporelles.

VORSICHT! Setzen Sie NIEMALS die Sicherheitseinrichtungen ausser Kraft, es koennte Personenschaden entstehen.

ATTENZIONE NON aggirate le disposizioni sulla sicurezza, potrebbero verificarsi danni alle persone.

PRECAUCIÓN NO saltarse el paquete de Seguridad, o alguna persona podría sufrir daños.



CAUTION DO NOT open the safety shielding while a program is running or a safety violation message will appear and the program will abort.

ATTENTION NE PAS ouvrir l'écran de protection quand un programme est en cours d'exécution, sinon un message de violation de la sécurité apparaîtra et le programme sera interrompu.

VORSICHT! Bei laufendem Programm dürfen Sie die Schutzabdeckung NICHT öffnen. Andernfalls wird ein Sicherheitsverstoß gemeldet und das Programm abgebrochen.

ATTENZIONE NON aprire la protezione di sicurezza durante l'esecuzione di un programma altrimenti apparirà un messaggio di violazione di sicurezza ed il programma verrà interrotto.

PRECAUCIÓN NO ABRA la protección de seguridad mientras se esté ejecutando un programa, si lo hace aparecerá un mensaje de violación de seguridad y se abortará el programa.

2. In the event the user needs to change the AC voltage, refer to [System AC Input Voltage Change](#) (pg 8.17) for details.
3. Verify that the black Power off button is pulled out. If your machine is not equipped with this control, refer to *Power Off* in the *Dispense System User Guide*.
4. Press the green Power On switch.

The system will automatically home the XYZ gantry when you turn on the power. The system must complete the homing sequence before other operations are possible. Continue with the following [Homing the System](#) instructions.

Homing the System

Homing Process

The homing process is a standard, automatic part of the power on procedure.

1. Wait until the system has completed the booting process. This may require waiting several minutes while status information displays. The main window and a prompt to home the system will display when the booting process is complete.
2. Click OK to home the system. Homing defines gantry coordinates for the system and is complete when all homing status messages disappear.
3. When only the main window remains, you may proceed with normal operations.

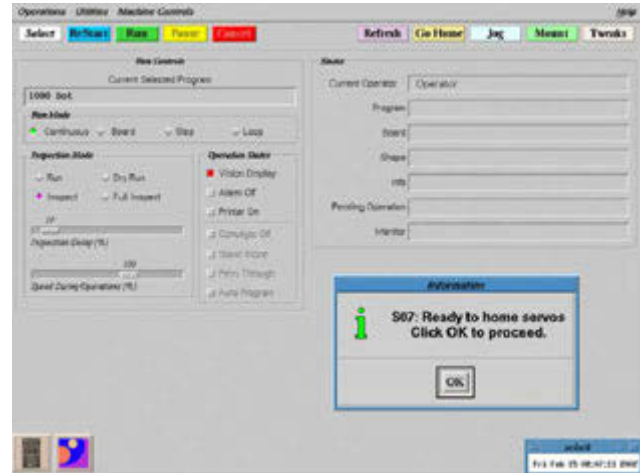

Homing Sequence

The process of homing the servo system sets up the encoders and serves to define where the gantry is for the system.

The homing sequence:

1. The gantry moves in Z axis to the Home sensor, and then moves to the index mark.
2. The gantry moves in Y axis to the Home sensor, and then moves to the index mark.
3. The gantry moves in X axis to the Home sensor, and then moves to the index mark.
4. The software instructs the gantry to move a certain number of counts from the index marks.

Power Off

Before powering off the machine, you must end any active program and perform the proper shutdown procedure.

IMPORTANT: Does your system use a **legacy control panel**? To find out, refer to [Legacy Controls & Operations](#) (pg 9.1) where alternative/legacy content is also available.

Prepare for Shutdown

Before you can perform the shutdown procedure, you must end any active program. It is also recommended that you unload all product from the dispense area and remove and clean the heads.

To prepare for shutdown:

1. Stop program execution with one of these methods:
 - If the Mount Board prompt is displayed, click ABORT, or
 - Click CANCEL on the main button bar.
2. After the program has ended, remove all product from the dispense area. For details, refer to *Unload Product* in the *Dispense System User Guide*.
3. Unload all heads (valves and tools):
 - a. Click REFRESH on the main button bar to move the gantry to the front of the machine where you can access the heads.
 - b. Remove the heads. For details, refer to *Mount Heads* in the *Dispense System User Guide*.
 - c. Clean the heads. For details, refer to head cleaning instructions under [Cleaning Pumps](#) (pg 5.71).
4. Continue with the following [Shutdown](#) instructions.

Shutdown

The machine can be left powered on as long as the safety system has not been bypassed, however, GPD Global recommends that you power off equipment when it is not in use.

To shutdown and power off the machine:

1. Perform the preceding [Prepare for Shutdown](#) procedure.
2. From the main menu bar, click on Operations > Shutdown System. A shutdown verification prompt displays.
3. Click YES to shutdown the system or CANCEL to abort the shutdown. Wait until a System Stopped prompt displays.
4. Power off the machine by pressing the black Power Off button.
5. Perform [Lock-Out](#) (pg 3.5) procedure.

Energy Isolation Procedures

Lock-Out



To ensure energy isolation, lock-out the equipment:

1. Turn off customer-supplied Lock-Out switch.
2. Turn off main power switch.
3. Install a lock or tag per your facility energy isolation procedures.
4. Test if system will start by pressing the Power On switch.
5. Test volt meter on known voltage source:
 - Test for presence of electrical power at TB1 and TB2 or at EMI Filter inlet L1 or L2.
 - Reconfirm volt meter on known voltage source.

Release Equipment from Lock-Out



To release equipment from customer-supplied Lock-Out switch:

1. Remove all tools, parts, and materials from the system.
2. Verify any and all work to ensure proper installation, polarity, connection.
3. Close all doors, covers, and shields.
4. Using facility-specific procedures, remove customer-supplied locks and/or tags.
5. Pull out the Power Off button.
6. Ensure the power cord is connected.
7. Turn on main power switch, watching for electrical or other failure.
8. Follow the [Power On](#) (pg 3.1) procedure.

4 Routine Maintenance



Maintenance procedures maintain the effectiveness of safety design features or devices (i.e., engineering controls).

This section, intended for maintenance personnel, lists pertinent safety instructions and suggested maintenance schedules, in addition to describing the tools and software instruments used to perform these routine procedures. Details are found in [Periodic Operations](#) (pg 5.1).

Safety Instructions



WARNING

Procedures requiring access to the machine's interior should only be performed by qualified maintenance or technical personnel fully aware of all safety precautions.

Consignes de sécurité AVERTISSEMENT

Les procédures exigeant l'accès à l'intérieur de la machine ne doivent être effectuées que par des personnes qualifiées du service technique ou de l'entretien connaissant parfaitement toutes les consignes de sécurité.

Sicherheitsanweisungen

ACHTUNG

Arbeitsvorgänge, bei denen auf das Innere der Maschine zugegriffen werden muß, dürfen nur von qualifiziertem Fachpersonal ausgeführt werden, das mit allen Sicherheitsvorkehrungen vertraut ist.

Istruzioni di sicurezza

AVVERTENZA

Le procedure che richiedono accesso all'interno dell'apparecchiatura devono essere eseguite soltanto da personale tecnico o qualificato per la manutenzione a conoscenza delle precauzioni di sicurezza.

Instrucciones de seguridad

ADVERTENCIA

Los procedimientos que requieren el acceso al interior de la máquina deben ser realizados por personal de mantenimiento o técnicos cualificados que conozcan las medidas de seguridad.



WARNING

Disconnect the power and air supplies prior to performing any machine maintenance whenever they are not required.

AVERTISSEMENT

Débrancher le courant et l'alimentation en air avant d'effectuer toute procédure exigeant l'accès à l'intérieur de la machine.

ACHTUNG

Vor der Durchführung von Arbeitsgängen, bei denen auf das Innere der Maschine zugegriffen werden muß, stets den Strom und die Luftzufuhr abschalten.

AVVERTENZA

Disinserire l'alimentazione e le forniture d'aria prima di eseguire qualsiasi procedura necessaria per accedere all'interno dell'apparecchiatura.

ADVERTENCIA

Antes de realizar cualquier procedimiento que requiera el acceso al interior de la máquina, desconecte la alimentación eléctrica y el suministro de aire.



IMPORTANT

Read all [Safety Notices](#).

IMPORTANT

Lire toutes les Instructions de sécurité.

WICHTIG

Alle Sicherheitsanweisungen lesen.

IMPORTANTE

Leggere tutte le Istruzioni di Sicurezza.

IMPORTANTE

Lea todas las Instrucciones de seguridad.

Schedules

Maintenance recommendations are based on 40-60 hours of run time per week. The following suggested schedules may need to be altered to accommodate your particular process requirements. A record of the maintenance performed should be maintained.

- [Daily Maintenance](#)
- [Weekly Maintenance](#)
- [Monthly Maintenance](#)
- [Quarterly Maintenance](#)
- [Semi-Annual Maintenance](#)
- [Annual Maintenance](#)

Daily Maintenance

Table 2: Routine Maintenance - Daily

Action			Location	Notes
Inspect	Clean	Replace		
	X		Overall machine	Perform general cleaning of the machine.
	X		Camera	<ul style="list-style-type: none"> • Clean camera body with soft, dry cloth. • Clean camera lens per CLEAN Camera Lens (pg 5.60). • Put lens cap on camera lens when camera is not in use.
	X		Surface sensor touch probe	Remove and clean touch probe tip per CLEAN Touch Probe (pg 5.70).
X		X	Needle Cleaner, Grip Type	If needle cleaner equipment is present, replace the soft jaw on each jaw base of the Grip Type Needle Cleaner as needed. Refer to CLEAN Needle Cleaner (pg 5.64).
	X		Scale, precision	If scale equipment is present, clean as needed per CLEAN Scale (pg 5.67).
X			Liquid dispense pump	If this pump is present, remove the pump per REMOVE / REPLACE Liquid Dispense Pump (pg 5.88) and, as needed, store the material syringe per manufacturer instructions.
	X		LX Auger pump	If this pump is present, clean per Cleaning Pumps (pg 5.71).
X	X		Micro-Dot pump	If this pump is present, the cartridge/feed tube/syringe assembly may be removed and refrigerated over night. Cleaning frequency is highly dependent on the type of material used. Refer to <i>Micro-Dot Pump Manual</i> (part number 22110265M) for details.
	X		Needle pump	If this pump is present, clean per Cleaning Pumps (pg 5.71).
X			Pinch tube pump	If this pump is present, clean per Cleaning Pumps (pg 5.71).
	X		Spool pump	If this pump is present, clean per Cleaning Pumps (pg 5.71).

Weekly Maintenance

(40-60 hours of run time)

Table 3: Routine Maintenance - Weekly

Action					Location	Notes
Inspect	Clean	Replace	Lubricate	Calibrate		
X					Overall machine	Inspect for loose or worn parts.
X					Encoders	Visually inspect for loose or worn parts and replace as necessary.†
X					Couplings	
X					Electrical system	Inspect for worn wiring or loose connections.
X					Air pressure	Inspect incoming system air pressure at machine connection to ensure it is set within the specification range. Refer to Specifications (pg 7.1). If air pressure adjustment is needed, refer to ADJUST Pump Air Pressure (pg 5.37).
X					X and Y gantries	Inspect for free travel.†
X					Motor coupler bolts	Inspect for loose or worn parts.†
	X		X		Lead screws	Lubricate per LUBRICATE Ball Screws & Linear Rails (pg 5.77).
	X		X		Linear rails	Lubricate the linear rail grease fittings per LUBRICATE Ball Screws & Linear Rails (pg 5.77).
X					Optical limit switches	Visually inspect optical limit switches.† They should be free of debris, securely mounted, and in good operating condition. Refer to TEST Safety Interlocks (pg 5.112).
X	X				Touch pad	Clean the touch pad on the calibration station. Refer to CLEAN Touch Pad (pg 5.69).
		X			Vision calibration dot label	For calibration station models prior to 2010 (not applicable to compact model) 1. Replace the vision target label on the calibration station. Refer to <i>Calibration Station</i> in the <i>User Interface</i> section of the <i>Dispense System User Guide</i> . 2. Reteach the camera calibration locations. Refer to the <i>Base Locations Reference Guide (PN 22100025)</i> .
		X			Purge cup	As needed, clean or replace the purge cup in the calibration station.
			X		Camera, Lipstick	If a shuttling carriage model of lipstick camera is present, lubricate the bearing rail and actuator with an oiled cloth or light grease. For further details, refer to the data sheets listed under Passive Camera (pg 5.22).

Table 3: Routine Maintenance - Weekly

Action					Location	Notes
Inspect	Clean	Replace	Lubricate	Calibrate		
				X	Scale, precision	If scale equipment is present: For best weighing results, calibrate scale on a regular basis. Refer to CLEAN Scale (pg 5.67).
	X		X		Piggyback dispenser shaft surfaces	<p>MAX SERIES ONLY If mount station 1 or 2 is present, wipe off and lightly oil the sliding shaft surfaces with a light oil to prevent pitting and scoring.</p> <p>DS SERIES ONLY If mount station 2 or 3 is present, wipe off and lightly oil the sliding shaft surfaces with a light oil to prevent pitting and scoring.</p>
					Pneumatic system	Inspect for loose or worn hoses and/or leaks. Refer to pneumatic schematic in <i>Mechanical & Electrical Reference</i> documents.
X	X				PCD pump	If this pump is present, inspect and clean per detailed instructions in <i>PCD Pump User Guide</i> as frequently as material dictates.

†

MAX SERIES ONLYRefer to *Mechanical & Electrical Reference* documents, drawing for XYZ Gantry Assembly.**DS SERIES ONLY**Refer to *Mechanical & Electrical Reference* documents, drawing for XYZ Gantry, XY Axis, and Z Axis Assembly.

Monthly Maintenance

Table 4: Routine Maintenance - Monthly

Action			Location	Notes
Inspect	Clean	Lubricate		
X			Backup data	Perform a Data backup. For details, refer to the <i>Routine Backups</i> section in the <i>FLOWare Software Guide</i> . Also, periodically delete obsolete backup files. Refer to the <i>FLOWare Software Guide</i> .
X			Conveyor belts	If a conveyor is present, inspect belt tension. If necessary, adjust tension per ADJUST Conveyor Belt Tension (pg 5.23). Inspect length of both belts for grays and wear spots. Immediately replace excessively worn or deteriorated belts. Refer to REMOVE / REPLACE Conveyor Belt (pg 5.86). <ul style="list-style-type: none"> • Inspect belts for signs of excessive wear. • Inspect belt seams for signs of deterioration or failure.
X		X	Conveyor width adjust unit	If a conveyor is present, inspect for loose or worn parts. Immediately replace excessively worn or deteriorated items.
	X		Camera	For DOWNWARD looking camera only: As needed, clean the camera lens per CLEAN Camera Lens (pg 5.60).
	X		Camera lamp diffuser	If the camera is equipped with a diffuser, clean and remove dust by twirling a dry cotton swab over the glass surface. Refer to CLEAN Camera Lamp Diffuser (pg 5.60).
	X		Paper roll for calibration station	As needed, replace paper roll in calibration station with a new roll. For older calibration station models with a paper roll discard bin, remove the used paper from the bin. For details, refer to <i>Paper Pad</i> in the <i>Dispense System User Guide</i> .

Quarterly Maintenance

Table 5: Routine Maintenance - Quarterly

Action			Location	Notes
Inspect	Clean	Replace		
X			Safety shield switches	Inspect and test. Refer to TEST Safety Interlocks (pg 5.112).
X			Power Off switch	Inspect and test to verify required function and operations: 1. Turn off Power Off switch. IMPORTANT: Does your system use a legacy control panel ? To find out, refer to Legacy Controls & Operations (pg 9.1) where alternative/legacy content is also available. 2. Test if system will start by pressing Power On switch. 3. Test volt meter on known voltage source. 4. Test for presence of electrical power at TB1 and TB2. 5. Reconfirm volt meter on known voltage source.
X			Status light tower	For non-LED models only Inspect, and replace as necessary, the light bulbs in the status light tower.

Semi-Annual Maintenance

Table 6: Routine Maintenance - Semi Annual

Action			Location	Notes
Inspect	Adjust	Calibrate		
X	X		Map work area	For high accuracy dispensers, map the work area to optimize precision control and application using the GPD Global Precision Contour Mapping Calibration Kit.
X	X		Conveyor speed	If a conveyor is present, inspect for proper conveyor speed and adjust as necessary. Refer to ADJUST Conveyor Speeds (pg 5.25).
X			Conveyor width adjust	If a conveyor is present and equipped with automatic conveyor adjust, perform the CALIBRATE Conveyor Width (pg 5.50).
X		X	Clear Vu Vision camera	<p>If this optional vision equipment is present:</p> <ol style="list-style-type: none"> 1. Calibrate the camera. Refer to Fine Tune Camera Perpendicularity (pg 5.17) 2. Remap the system. Refer to <i>Precision Contour Mapping Calibration for FLOWare Software</i> (document part number 221MAPDOC). <p>To realign the camera:</p> <ol style="list-style-type: none"> 1. Perform ADJUST Camera/Lens Alignment (pg 5.5). 2. Map the system. Refer to <i>Precision Contour Mapping Calibration for FLOWare Software</i> (document part number 221MAPDOC). 3. Reteach base locations. Refer to the <i>Base Locations Reference Guide (PN 22100025)</i>.

Annual Maintenance

Table 7: Routine Maintenance - Annual

Action					Location	Notes
Inspect	Clean	Adjust	Lubricate	Calibrate		
X					System guards and covers	Inspect for worn or damaged parts and test to verify parts operate freely. Reinstall all bolts and replace any missing fasteners.
X	X				FLOware control software	If the job accounting/management info option is turned on in the FLOware software, perform PURGE Accounting Data (pg 5.78).
				X	Temperature controllers	If temperature controllers are present and if company policy dictates, calibrate each temperature controller. Refer to OEM documentation.
	X		X		Conveyor belt drive chain	DS SERIES ONLY If a conveyor is present, clean and lubricate the conveyor belt drive chain per LUBRICATE Conveyor Belt Drive Chain (pg 5.76).
X		X			Dispense control panel air gauges and gantry buzz boards	DS SERIES ONLY As needed, adjust minimum and maximum air pressure values displayed on air pressure gauges to match pump syringe air pressure source. For details, refer to ADJUST Pump Air Pressure (pg 5.37).

Spare Part Kits

Many of the spare parts kits available for use with our dispensing machines, devices, stations, and pumps are illustrated and listed in detail in the *KITS for Dispensers & Related Equipment* (p/n 22290036).

Tools & Equipment

The mechanical tools discussed in this section are included in the Setup & Leveling Kit. The software instruments discussed are associated with the FLOWare control software.

The Setup & Leveling Kit (part no. 22110142) includes a [Dial Indicator](#), a [Setup Level](#), and a [Head Calibration Tool](#). The dial indicator and setup level are typically used for obtaining precise results such as when testing and adjusting the parallelism of the work area plate to gantry travel. The head calibration tool emulates a pump or tool for various tasks; it is most commonly used to teach base locations.

The [IO Viewer](#) feature is included in the FLOWare control software and can be used to test device functions. The Contour Mapping Software package is included with the optional [Contour Mapping Calibration Kit](#) for optimizing precise positioning/placement.

Dial Indicator

The dial indicator is typically used to adjust the tooling and lifter plates parallel to gantry travel. The dial indicator is included in the Setup & Leveling Kit (part no. 22110142).

To mount the dial indicator in a mounting bracket:

- Select the following items from the Set Up & Leveling Kit:
 - dial indicator mount
 - dial indicator
 - washer
 - screw
- Using a 3/16" allen wrench, screw the dial indicator onto the dial indicator mount with the provided washer and screw.
- Determine the type of tool mount with which your machine and tooling are equipped and follow the instructions below that apply to your equipment. There are three different types of tool mounts: [Taper-Lock Mount](#), [Ball Lock Mount](#), and [Clamp Mount](#).

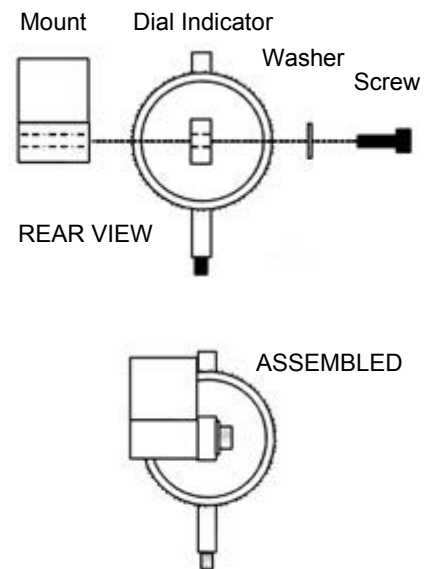

Taper-Lock Mount

- Press down and hold the latching lever at the top of the mount.
- Align and engage head with the top dowel pin of the mount.
- Apply downward pressure to the head while releasing the latching lever.

Ball Lock Mount

- Press upward and hold the latching lever at the base of the mount.
- Align the ball lock pin on the head with the ball lock on the mount. Press the head into the mount.
- Release the latching lever.

Clamp Mount

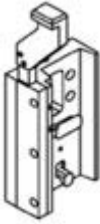

1. (Using a 3/32" allen wrench, loosen the mounting bracket's clamp bar set screw in the head mount station.
2. Slide the head into the mounting bracket until it seats against the stop pin.
3. Secure the head in place by tightening the set screw.

Setup Level

The 4" setup level is typically used along with the machine leveling feet to level the gantry. The setup level is included in the Setup & Leveling Kit (part no. 22110142).

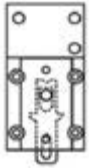

A typical leveling scenario:

1. Place the 4" level on one of the machine X-axis linear rails.
2. As necessary, adjust machine height using the leveling feet.
3. Repeat the above process for the Y-axis linear rail.

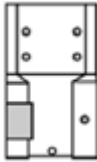

Head Calibration Tool

The Head Calibration Tool can be mounted in any of the head mount positions, and is used to emulate a pump or tool. The Head Calibration Tool is included in the Setup & Leveling Kit (part no. 22110142).

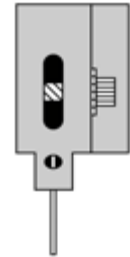

To mount the Head Calibration Tool in a head mount position:

1. Jog the gantry to a location accessible to the operator near the front of the work area.
2. Open the safety shield.
3. Identify which mount position bracket coordinates with the head mount position to be taught. Use the illustrations below to help identify the desired head mount position.

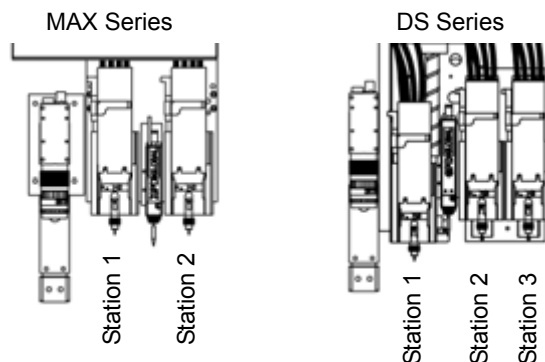

- Determine the type of tool mount with which your machine and tooling are equipped and follow the instructions below that apply:

Taper-Lock Mount

- Press down and hold the latching lever at the top of the mount.
- Align and engage the Head Calibration Tool with the top dowel pin of the mount.
- Apply downward pressure to the Head Calibration Tool while releasing the latching lever.

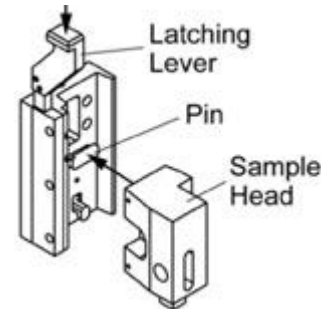

Ball Lock Mount

Press upward on the mount latching lever, press the Head Calibration Tool on the tool into the mount, and then release the mount latching lever.

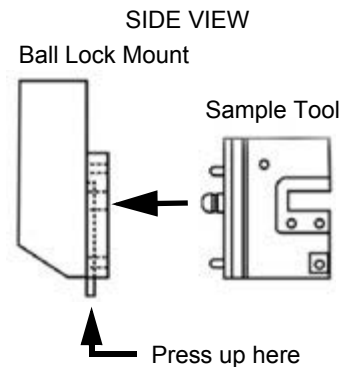

Clamp Mount

- Loosen the mounting bracket's set screw until the clamp bar opens enough to accommodate the Head Calibration Tool.
- Slide the Head Calibration Tool into the mounting bracket so it seats against the stop pin.

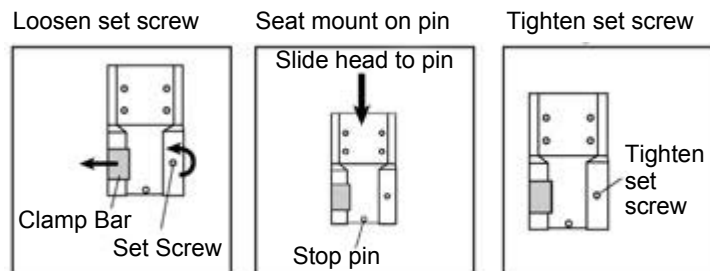

NOTE: In order to accommodate the vertical adjustments of a standoff needle, the stop pin may have been removed or pushed in flush with the mounting bracket surface. If this is the case, use the stop pin hole as a visual guide to mount the Head Calibration Tool in the same vertical position that would result if the stop pin were available to use as a physical stop.

- Firmly tighten the mounting bracket set screw.
- Close the safety shield. You have completed mounting the head calibration tool.

Contour Mapping Calibration Kit

The Contour Mapping Calibration Kit is used to map the dispense area for precise movement, optimizing precision control and reducing errors in positioning/placement caused by mechanical imperfections. For precision of less than 0.003" (0.076 mm) mapping is required. For high accuracy applications, mapping should be done at least every six months (more often depending on usage) and every time the dispensing system is moved.

For step-by-step instructions, refer to the document accompanying the Precision Contour Mapping Calibration Kit. Call GPD Global for the kit part number applicable to your model of dispense system.

IO Viewer

The IO Viewer may be used as a maintenance or troubleshooting tool to help determine if a device input or output (I/O) is wired properly and receiving the correct voltage. You may force an output device with IO Viewer by clicking on the box next to the I/O label and observing the results. An input cannot be forced, but you can "flag" a sensor and watch to see if the box next to the I/O label changes state, or you can observe if an I/O is reading a change of condition.

For instructions on how to use the IO Viewer, refer to the *FLOware Software Guide*.

5 Periodic Operations

This section includes detailed instructions for various maintenance functions that may need to be performed periodically.

- [Adjustment Procedures](#) (pg 5.2)
- [Calibration Procedures](#) (pg 5.46)
- [Cleaning Procedures](#) (pg 5.58)
- [Lubrication Procedures](#) (pg 5.76)
- [Purging Procedures](#) (pg 5.78)
- [Remove/Replace Procedures](#) (pg 5.80)
- [Setup Procedures](#) (pg 5.90)
- [Testing Procedures](#) (pg 5.111)

Adjustment Procedures

- [ADJUST Calibration Station Height](#) (pg 5.2)
- [ADJUST Calibration Station - Level Surface](#) (pg 5.2)
- [ADJUST Calibration Station Light Intensity](#) (pg 5.4)
- [ADJUST Camera/Lens Alignment](#) (pg 5.5)
- [ADJUST Camera Settings](#) (pg 5.22)
- [ADJUST Conveyor Belt Tension](#) (pg 5.23)
- [ADJUST Conveyor Sensor Sensitivity](#) (pg 5.24)
- [ADJUST Conveyor Speeds](#) (pg 5.25)
- [ADJUST Conveyor Support & Height](#) (pg 5.26)
- [ADJUST Conveyor Width](#) (pg 5.30)
- [ADJUST Needle Standoff Distance](#) (pg 5.33)
- [ADJUST Temperature Controller](#) (pg 5.35)
- [ADJUST Pump Air Pressure](#) (pg 5.37)
- [ADJUST Scale Settings & Parameters](#) (pg 5.34)
- [ADJUST Scale to Level](#) (pg 5.34)
- [ADJUST Work Area Lifter Plate](#) (pg 5.38)
- [ADJUST Work Area Tooling Plate](#) (pg 5.43)

ADJUST Calibration Station Height

The height of the calibration station can be raised/lowered as needed. Follow the surface leveling instructions here: [ADJUST Calibration Station - Level Surface](#) (pg 5.2).

ADJUST Calibration Station - Level Surface

The height of the calibration station can be adjusted as needed for the purpose of leveling the surface of the calibration chip.



CAUTION The calibration station must be level - its position is critical to the accuracy of the calibration process. Make adjustments only when necessary because realignment of the calibration station requires reteaching and reverifying base locations.

Helpful Tips:

- Set camera focus at target height, position camera above the calibration station, and then raise/lower the calibration station until desired target surface comes into focus.
- Perform the above process using the dial indicator instead of the camera.

Tools Required:

- Dial Indicator from Setup & Leveling Kit (PN 22110142)
 - 3/16 Allen wrench
1. Install the dial indicator in the head mount station per standard instructions in the *Dispense System Service Guide*.

2. Check for a level plane across the surface of the calibration station using the dial indicator to indicate at least three (3) points.

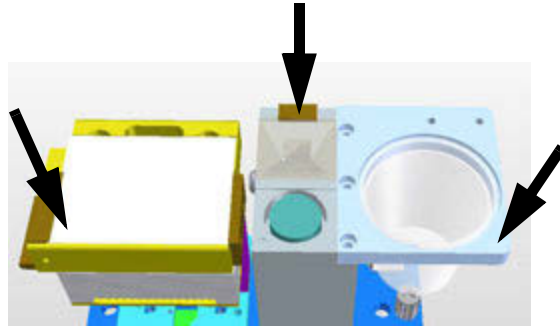

3. If leveling is required, loosen the two lock screws with a 3/16 Allen wrench and then use the three calibration station leveling screws and wrench to adjust the calibration chip surface until it is level.

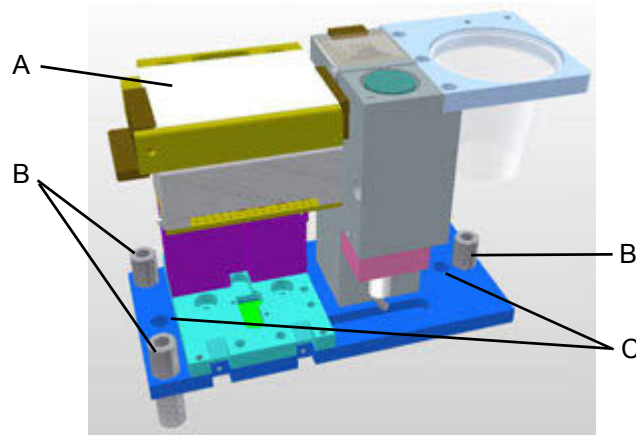

A - Calibration Chip

B - Leveling Screw

C - Lock Screw

ADJUST Calibration Station Light Intensity

If desired, the intensity of the light emitted through the ceramic chip by all backlit models of the calibration station can be adjusted to accommodate your processing needs.

Compact Models

Using a very small screwdriver, adjust the trim pot to the desired light intensity.

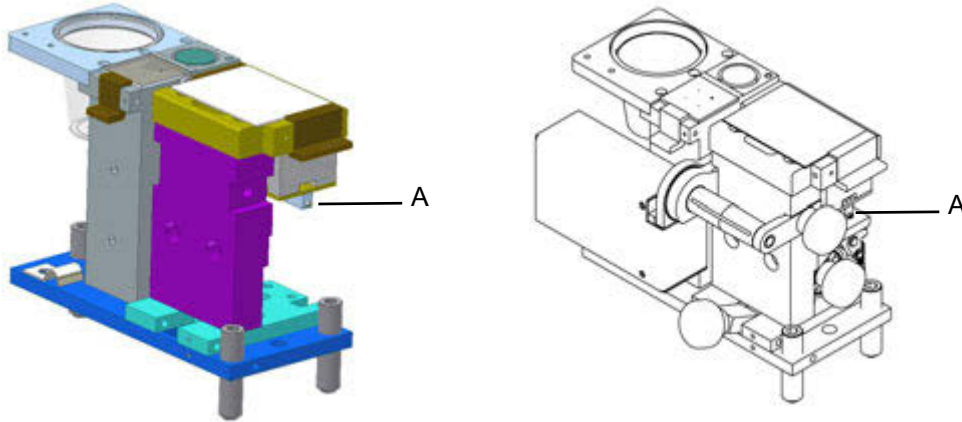

A - Trim Pot

Legacy Models

Remove the ceramic chip to reveal a trim pot located beneath the chip area. Adjust the trim pot to achieve desired light intensity.

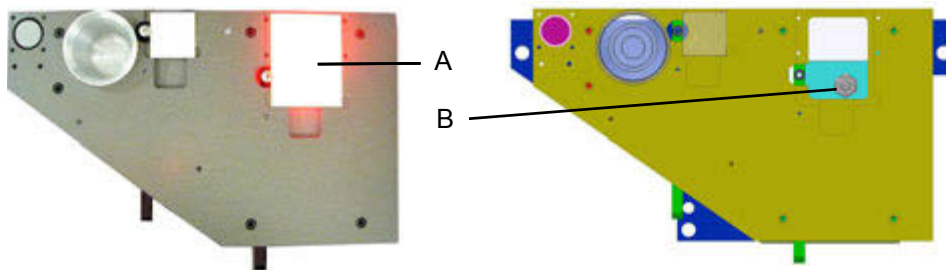

A - Ceramic Chip

B - Trim Pot

ADJUST Camera/Lens Alignment

For ClearVU Vision option only:

Use these instructions to:

- fine tune camera-to-lens alignment, camera-to-work area alignment, and camera perpendicularity

OR

- fully align camera and lens after either device has been replaced or removed from system and then reinstalled.



CAUTION Camera alignment is critical to the accuracy of the dispense process. ONLY make adjustments to the ClearVu™ Vision camera or lens on an as needed basis. Realigning the vision system is an involved process and **any change to the camera or lens may require changing all models/patterns used by your programs.**



IMPORTANT Loosening or tightening any of the set screws on the camera/lens adapter or lens can cause misalignment of the camera and lens. Either of these actions can also affect the camera-to-work area alignment. It is wise to periodically check the camera-to-work area alignment while implementing this camera-to-lens adjustment.



IMPORTANT The amount of time required to perform this procedure ranges from 45 minutes for a technician experienced with this process to several hours or more for a technician performing this process for the first time.

NOTE: Whenever you are instructed to adjust the Zoom slide bar in the Jog window, be aware that you may also need to adjust the Gain setting to accommodate increased light at 100% Zoom and reduced light at 0% Zoom.

Tools Required

- ClearVU Vision Focus Tool Kit (PN 22295104)
- Dial Indicator from Setup & Leveling Kit (PN 22110142)
- Allen wrenches: 3/32, 3/16, and two 5/64

Parts Identification

Camera, Lens, Adapter

The ClearVu Vision assembly consists of a camera, a lens, and an adapter between the camera and lens.

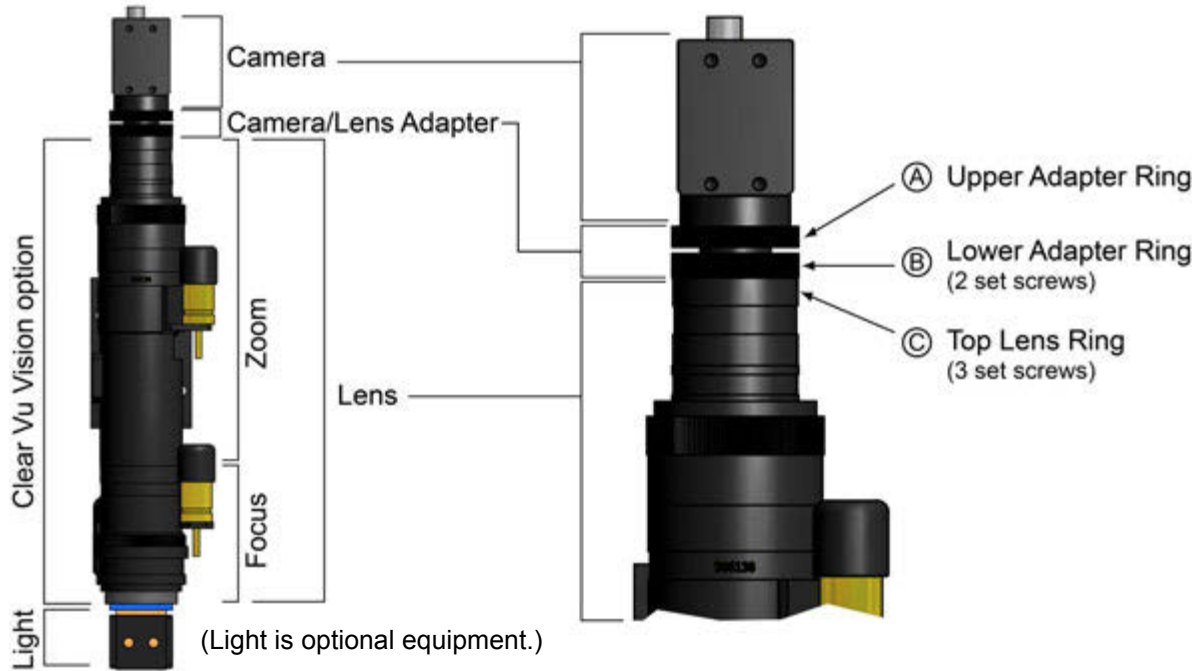

Camera Focus Tool Kit

The ClearVU Vision Focus Tool Kit (PN 22295104) consists of a focus tool, a leveling unit, and an adapter plate.

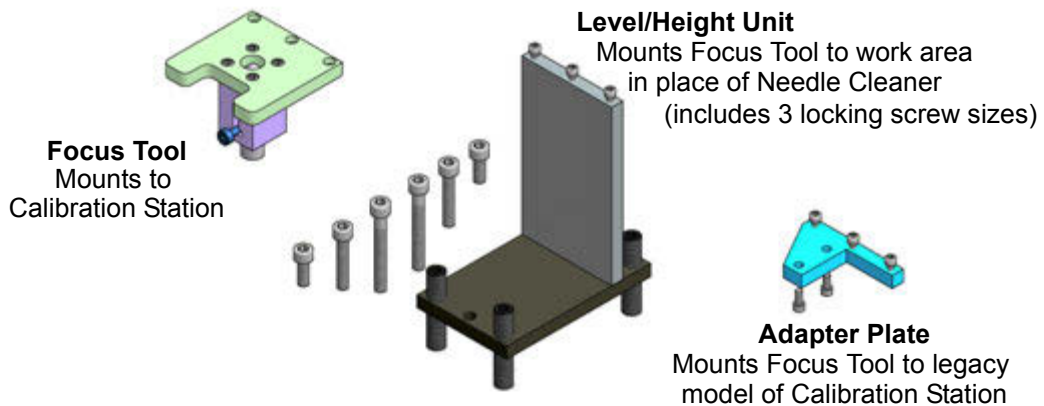

1- Vertical Adjustment for Focal Range

To adjust vertical position of the camera and thereby adjust focal range:

1. Turn on system power.
2. Fully retract the lens by setting the Focus slide bar in the Jog window to 0%.

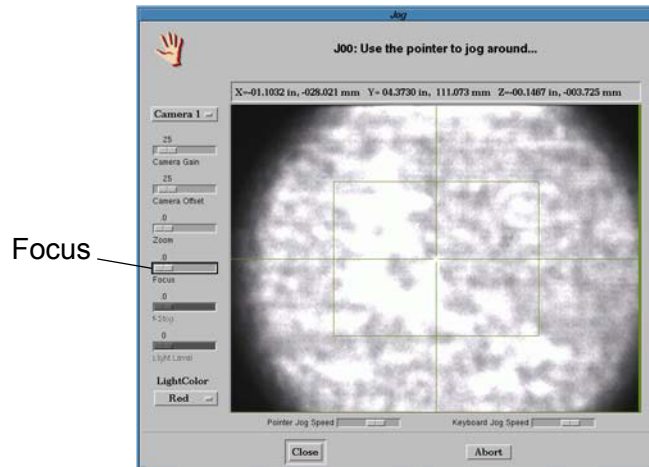

3. While supporting the lens assembly, loosen the height adjustment bolts per the appropriate model:

Figure 1: Location of focus height adjustment bolts on camera bracket

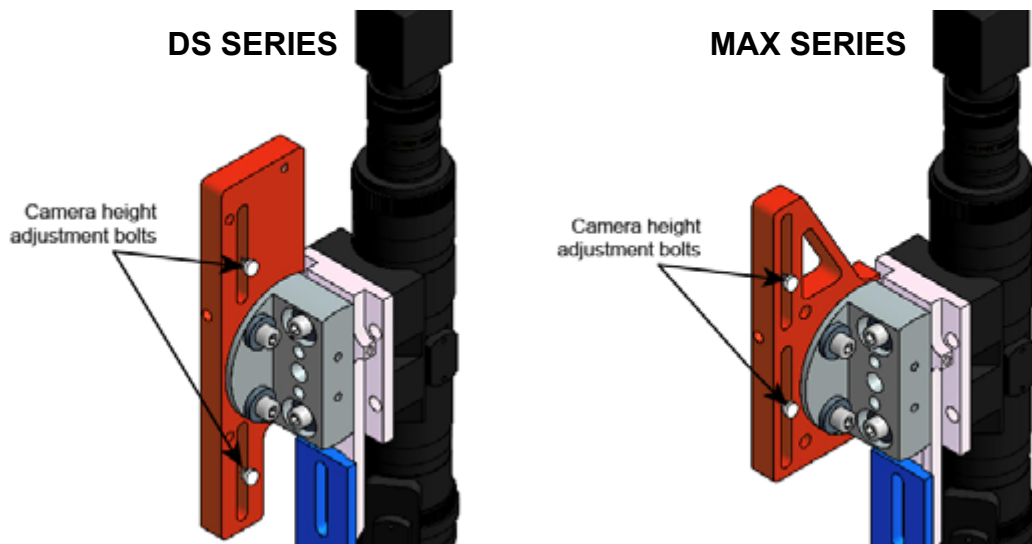

- Set the end of the lens to a height of 2.2" (56 mm) above the work table surface as shown here.

Figure 2: Set camera to a measured distance between fully retracted lens and work table surface.
(Optional light may be present.)

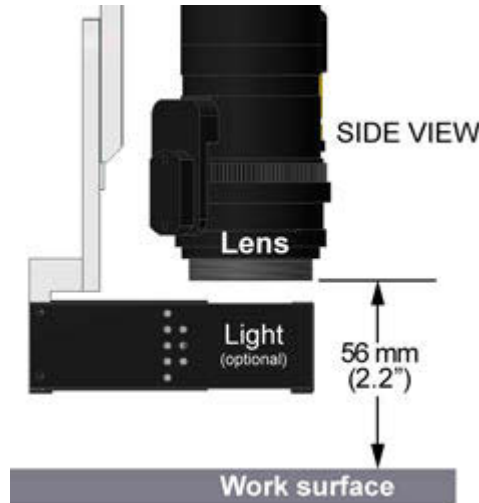

- Tighten the height adjustment bolts.

2- Set Focus (0 to 100% Zoom)

An image should remain in clear focus through the full zoom range (0% to 100%). If it does not do so, adjust for proper focal length (the distance between the camera and the lens) by stepping through the following trial and error process:

- Using the Jog window, set Zoom to 100%.
- Jog the camera over the Camera Calibration Dot on the calibration station and use the Focus slide bar in the Jog window to adjust focus so a clear image of the Calibration Dot displays.

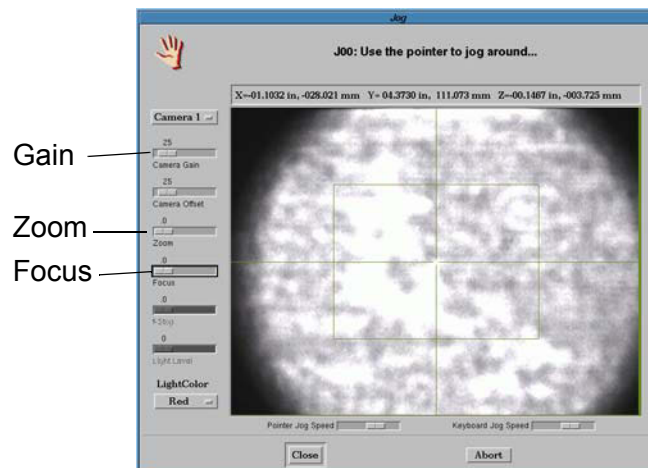

3. Set the Zoom to 0%. The image should remain in clear focus.
 - If focus remains clear, skip to [Align Camera with Work Area](#) (pg 5.13).
 - If focus blurs, continue with step 4 to achieve clear focus.

Figure 3: Camera/Lens adjustment rings.

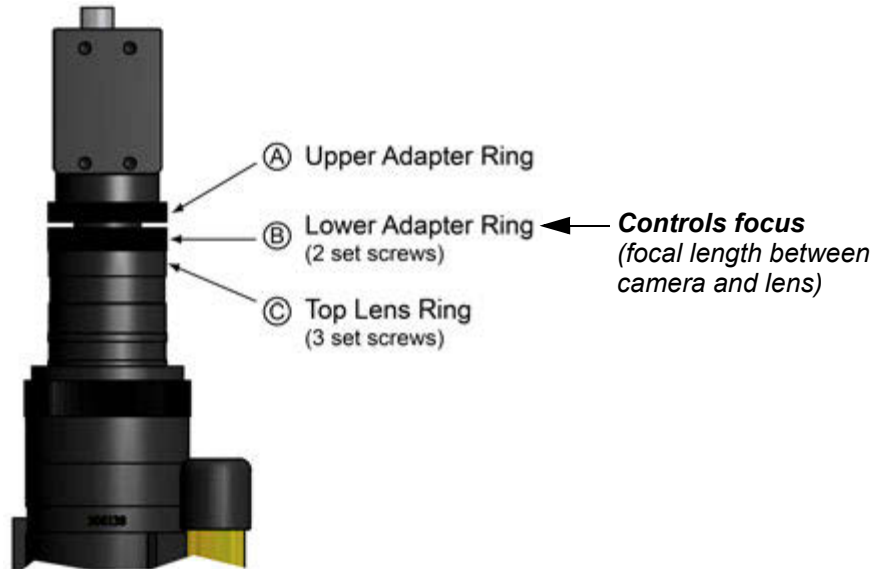

4. Loosen the set screws in these rings:
 - Lower Adapter Ring (Item B)
 - Top Lens Ring (Item C)
5. Begin the focusing process with Item B and Item C touching: manually turn Item B until it touches Item C.
6. Repeat the following steps until clear focus is achieved at both 0% and 100% zoom without having to change focus:
 - a. Increase the distance of Item B from Item C by turning Item B 1/8 rotation turn.
 - b. Set the Zoom to 100%.
 - c. Use the Focus slide bar to set focus to a clear image.
 - d. Set the Zoom to 0%.
 - e. If the image is blurred, return to step a. If the image is clear, continue with the next step.
7. Tighten the set screws in Item B and Item C.
8. Verify that clear focus is maintained through the full zoom range by setting Zoom to 100% and then to 0%.
 - If focus remains clear, proceed to [Align Camera with Work Area](#) (pg 5.13).
 - If focus blurs, loosen the set screws in Item B and Item C, and then begin again at step 6 to adjust for clear focus.

3- Camera-to-Lens & Camera-to-Work Area Alignment

When the camera-to-the-lens alignment is correct, dot location relative to the cross hairs in the Jog window video area will remain unchanged throughout the full range of zoom settings.

Figure 4: Example of dot maintaining its location relative to cross hairs through full zoom range (0-100%)

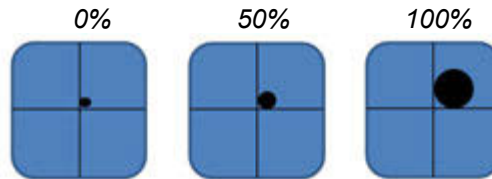

If cross hair position at 0% zoom differs from cross hair position at 100% zoom, the camera and lens need to be aligned.

The process of aligning the camera to the lens involves setting the proper alignment between the camera cross hairs and the center of the lens at both ends of the lens zoom range.

CAUTION Camera alignment is critical to the accuracy of the dispense process. ONLY make adjustments to the ClearVu™ Vision camera or lens on an as needed basis. Realigning the vision system is an involved process and **any change to the camera or lens may require changing all models/patterns used by your programs.**

IMPORTANT Loosening or tightening any of the set screws on the camera/lens adapter or lens can cause misalignment of the camera and lens. Either of these actions can also affect the camera-to-work area alignment. It is wise to periodically check the camera-to-work area alignment while implementing this camera-to-lens adjustment.

IMPORTANT The amount of time required to perform this procedure ranges from 45 minutes for a technician experienced with this process to several hours or more for a technician performing this process for the first time.

Align Camera to Lens

Tool Required: two 5/64 wrenches

1. Test current alignment:
 - a. Set the Zoom to 100%.
 - b. Jog the camera so the cross hairs are positioned at the edge of the calibration dot (as shown in Figure 5 at left).

Figure 5: Dot aligned with cross hairs at 100% and 0% Zoom

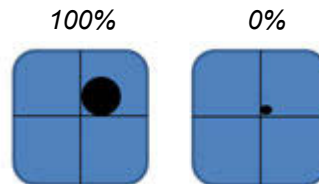

- c. Set Zoom to 0%. Ideally, the dot should maintain the same location relative to the cross hairs (as shown in Figure 5 at right).
2. If dot position remained unchanged, skip to step 4. If dot position moved and is no longer aligned as shown in Figure 5, continue with step 3.
3. Read all instructions in this step before taking action!

To adjust cross hair position to the edge of the dot when at 0% Zoom, apply light pressure to top of the camera while observing dot position in the Jog screen and making **small incremental** changes to the three set screws on the Lens Ring (Item C).



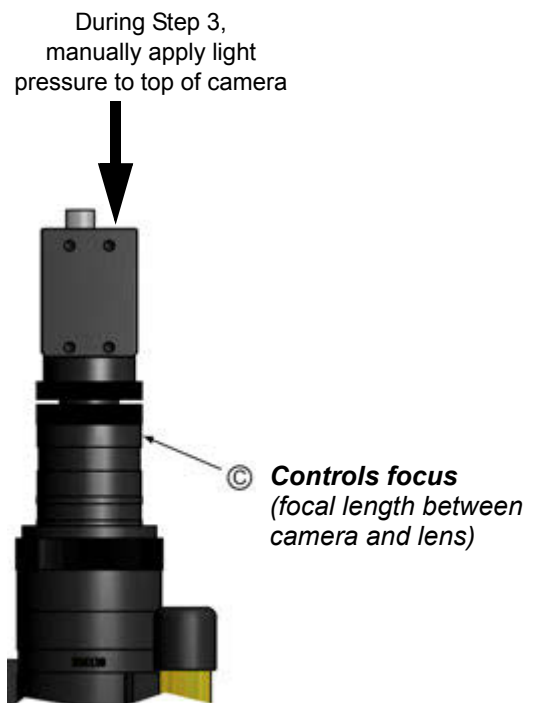



~ continued ~

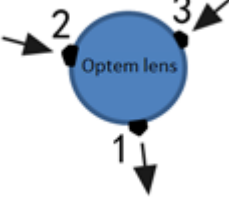

Use the guide in Table 8 (below) to aid in deciding which set screw(s) to adjust and in what direction to adjust each set screw.

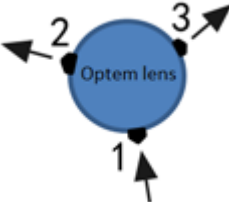
⚠ IMPORTANT Always adjust at least one of the “OUT” moving screws before adjusting any of the “IN” moving screws.

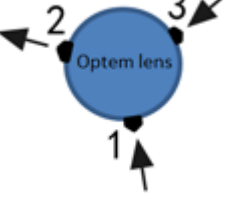
Table 8: Set Screw/Cross Hair Adjustment Based on Dot Movement

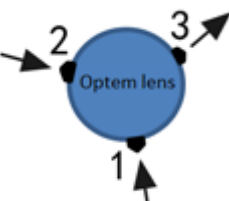
Dot Movement:	Adjust Set Screws to Move Cross Hairs
 <p>Jog Window</p>	 <p>If dot moves DOWN when zooming out, move cross hairs DOWN by adjusting:</p> <ul style="list-style-type: none"> •set screw 1 OUT •set screw 2 IN •set screw 3 IN
 <p>Jog Window</p>	 <p>If dot moves UP when zooming out, move cross hairs UP by adjusting:</p> <ul style="list-style-type: none"> •set screw 2 OUT •set screw 3 OUT •set screw 1 IN
 <p>Jog Window</p>	 <p>If dot moves LEFT when zooming out, move cross hairs LEFT by adjusting:</p> <ul style="list-style-type: none"> •set screw 2 OUT •set screw 1 IN (if necessary) •set screw 3 IN
 <p>Jog Window</p>	 <p>If dot moves RIGHT when zooming out, move cross hairs RIGHT by adjusting:</p> <ul style="list-style-type: none"> •set screw 3 OUT •set screw 1 IN (if necessary) •set screw 2 IN

4. Repeat step 1 through 3 until **alignment is perfect**. When perfect alignment is achieved, continue with [Align Camera with Work Area](#) (pg 5.13).

Align Camera with Work Area

Rotate the camera so it is square with the work area:

1. Jog the camera so the horizontal cross hair in the video screen is in close proximity to a horizontal edge of a conveyor rail or batch plate as shown in Figure 6.

Figure 6: Use Jog video screen to inspect alignment of horizontal camera cross hair. Good alignment between the two is shown here.

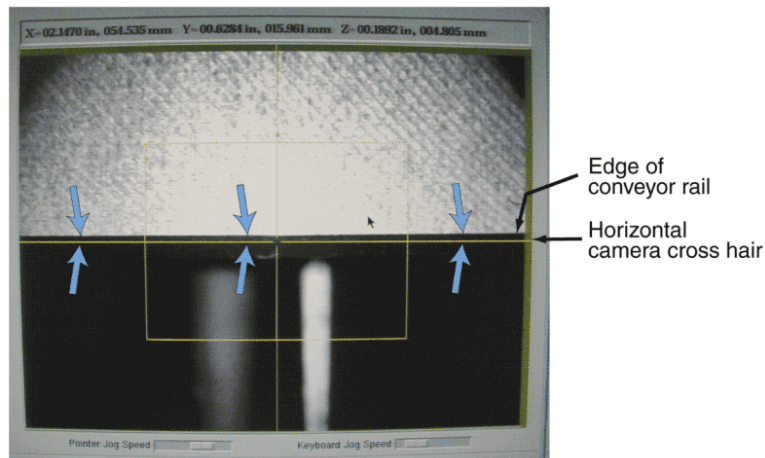

2. Inspect alignment of the horizontal cross hair with the horizontal image. A difference of less than 1 degree in alignment is considered acceptable.
 - If alignment is acceptable, skip to step 4.
 - If alignment is unacceptable, proceed to step 3.
3. Adjust alignment of camera with work area:
 - a. Make gross adjustments by equally loosening the three set screws in Item C (Figure 7) **in small increments** - just enough to allow the camera to rotate.

Figure 7: Camera/Lens adjustment rings.

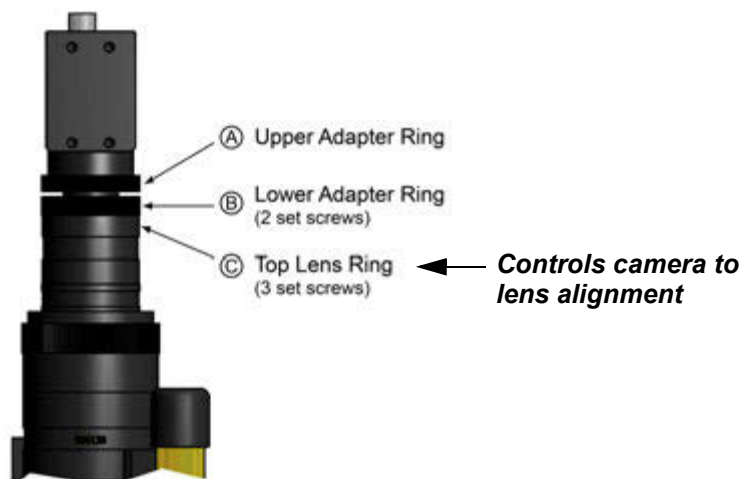

- b. Carefully rotate the camera until horizontal alignment is achieved.
 - c. Equally snug the set screws in small increments.
 - d. Repeat step 2.
4. When alignment is judged to be acceptable, continue with [Verify Alignments](#) (pg 5.14).

Verify Alignments

To verify alignment of camera to lens and camera to work area:

1. Slightly tighten the set screws of Item C (Figure 7) **in small increments** using Allen wrench.



CAUTION Do not over tighten set screws or else screws may mar the precision mounting surface, making alignment more difficult.

2. Re-verify focus, horizontal, and center line at 100% Zoom and 0% Zoom. If alignment is good, proceed to next step. If further alignment adjustments are needed, repeat step 3 of [Align Camera to Lens](#) (pg 5.11),

4- Camera Perpendicularity

This section guides you through verifying the perpendicularity of the camera to the dispenser work area. You will make adjustments as needed to make the camera perpendicular to the top surface of the work area.

Rough Adjustments

CAUTION Camera alignment is critical to the accuracy of the dispense process. ONLY make adjustments to the ClearVu™ Vision camera or lens on an as needed basis. Realigning the vision system is an involved process and **any change to the camera or lens may require changing all models/patterns used by your programs.**

To approximate the camera position for perpendicularity to the work area, perform both [Side-to-Side Adjustment](#) (pg 5.15) and [Front-to-Back Adjustment](#) (pg 5.16).

Side-to-Side Adjustment

1. Inspect the perpendicularity of the camera to the top surface of the dispenser work area by using a machinist square and the top surface of work area to inspect the side vertical plane of camera.
2. If adjustments are needed, loosen the two bolts (Item 4 in Figure 8) that secure the side vertical plane of the camera.
3. Adjust camera position using the side-to-side adjustment screw (Item 3 in Figure 8).
4. Verify the perpendicularity of the camera to the dispenser, tighten the bolts, and then re-verify perpendicularity again.

Figure 8: Camera bracket side-to-side and front-to-back adjustment screws.

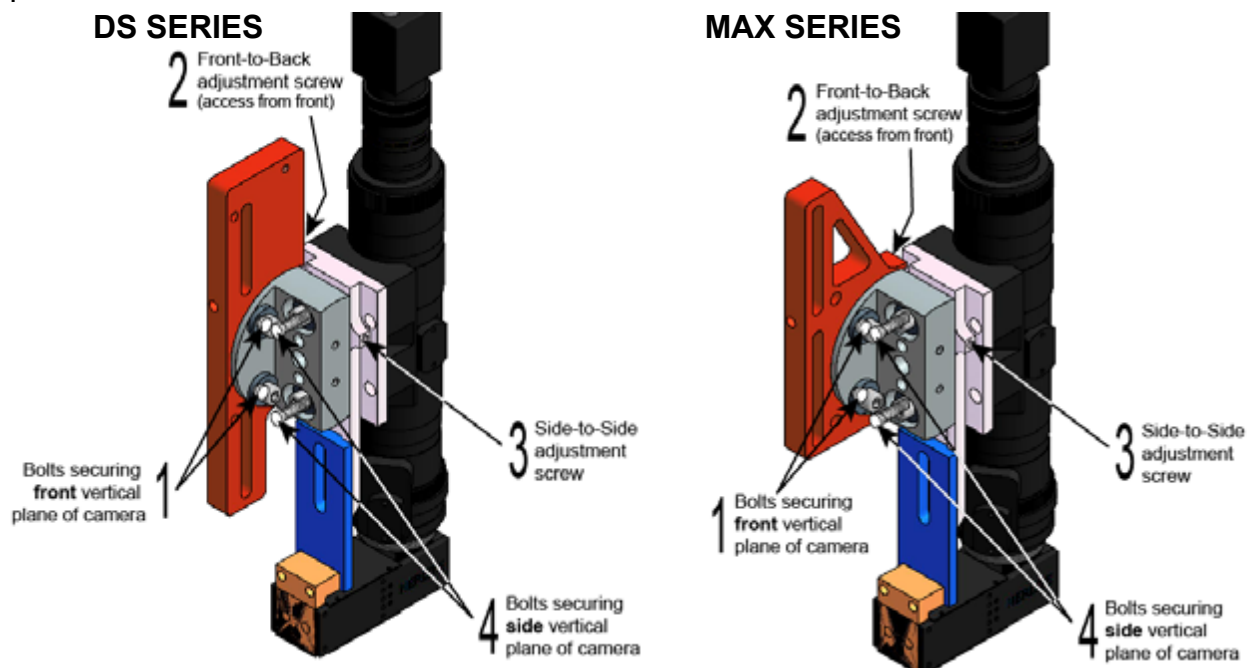

Front-to-Back Adjustment

1. Inspect the perpendicularity of the camera to the top surface of dispenser work area by using a machinist square and the top surface of work area to inspect the front vertical plane of camera.
2. If adjustments are needed, loosen the two bolts (Item 1 in Figure 8) that secure the front vertical plane of the camera.
3. Adjust camera position using the front-to-back adjustment screw (Item 2 in Figure 8).
4. Verify the perpendicularity of the camera to the dispenser, tighten the bolts, and then re-verify perpendicularity again.

Fine Tune Camera Perpendicularity

⚠ CAUTION Camera alignment is critical to the accuracy of the dispense process. ONLY make adjustments to the ClearVu™ Vision camera or lens on an as needed basis. Realigning the vision system is an involved process and **any change to the camera or lens may require changing all models/patterns used by your programs.**

Tools Required:

- ClearVU™ Vision Focus Tool Kit (PN 22295104)
- Dial Indicator from Setup & Leveling Kit (PN 22110142)
- Allen wrenches: 3/32 and 3/16

1) Install Focus Tool

Mounting the Focus Tool in any one of the noted locations provides a standardized reference point at which camera perpendicularity can be tested and proved. The Focus Tool can be mounted on a calibration station or in place of the needle cleaner.

1. Mount the Focus Tool in one of the following locations:

Calibration Station

Mount the Focus Tool to the calibration station using a 3/32 Allen wrench, replacing the purge cup bracket with the Focus Tool.

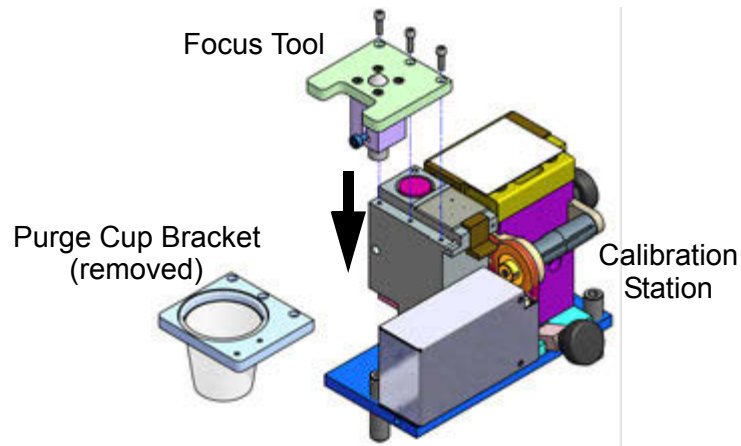

Calibration Station (legacy model)

Mount the Focus Tool to the Adapter Plate, and then mount the Adapter Plate to the legacy model of calibration station.

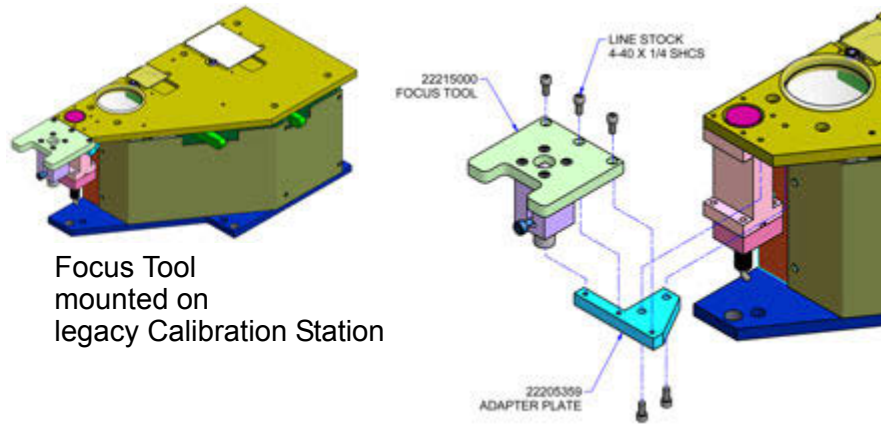

Focus Tool
mounted on
legacy Calibration Station

Needle Cleaner Station Site

- (1) - Remove the Needle Cleaner from work area and set aside, noting the length of locking screws used.
- (2) - Mount the Focus Tool to the Level/Height Unit.
- (3) - From the 3 sets of locking screws included with the Level/Height Unit, select the set with a length similar to those used with the Needle Cleaner.
- (4) - Mount the Level/Height Unit to the work area where the Needle Cleaner was previously located.

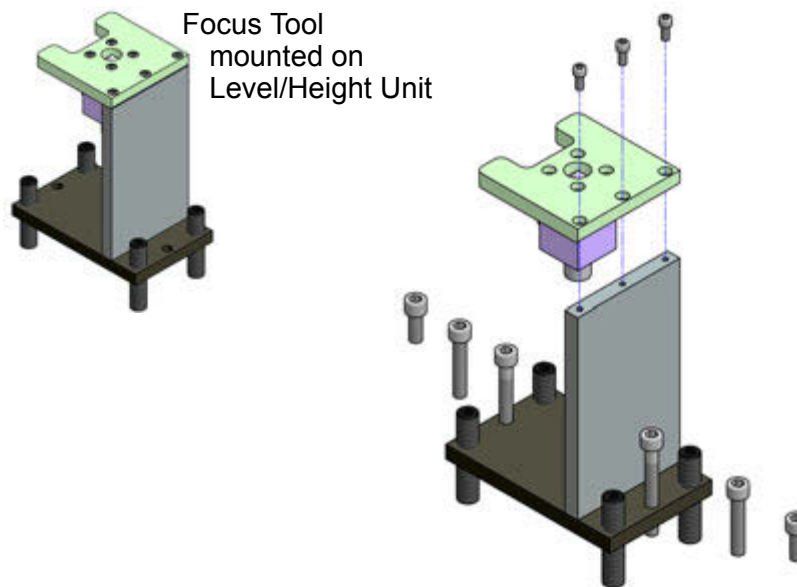

2. Verify that the surface of the Focus Tool is level:
 - a. Install the dial indicator in a head mount station per instructions in the *Dispenser Service Guide*.
 - b. Check for a level plane across the surface of the focus tool using the dial indicator to indicate three (3) points on the focus tool surface.

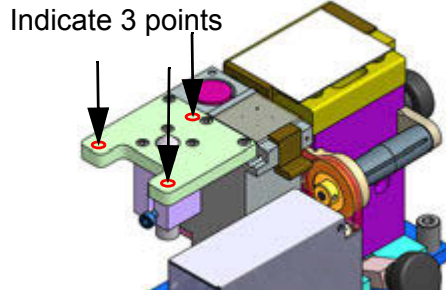

- c. If leveling is required, loosen the two lock screws with a 3/16 Allen wrench and then use the three calibration station leveling screws and the 3/16 Allen wrench to adjust the top surface until it is level.



IMPORTANT The surface of the focus tool should be level if the calibration station has been leveled in the past for the purpose of making the calibration chip surface level; however, if the focus tool is NOT level when installed on the calibration station, then leveling is necessary but doing so will corrupt the calibration chip level and **re-leveling of the calibration chip will need to be performed** after camera perpendicularity is established

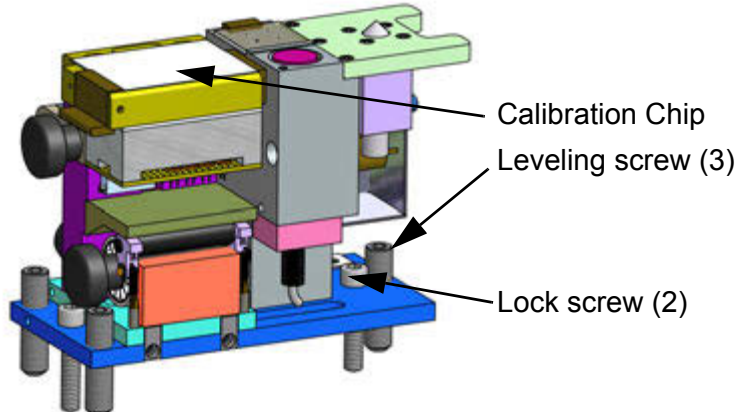

- d. If leveling was performed during the prior step, make a note to re-level the calibration chip/calibration station after the process of establishing camera perpendicularity is complete.

2) Prove Perpendicularity

The alignment of the camera cross hairs on the point of the Focus Tool plunger should remain unchanged throughout the full 0.470" (11.9 mm) vertical distance represented by the stroke of the focus tool plunger.

To verify the camera is perpendicular throughout the full extent of the vertical focal range:

1. Slide the focus tool plunger into its fixed DOWN position.

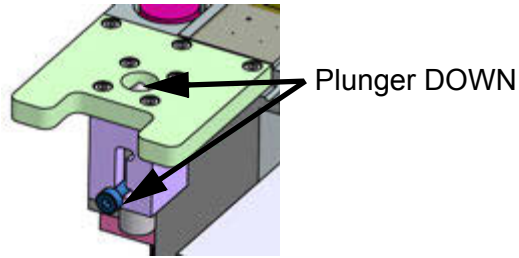

2. Jog the camera over the focus tool so the camera cross hairs align on the point of the plunger.

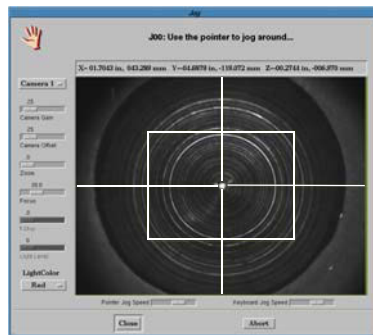

Cross hairs aligned over point of lowered plunger.

3. Set the Zoom to 0%.
4. Use the Focus slide bar to adjust focus so a clear image displays.
5. Slide the focus tool plunger into its fixed UP position.

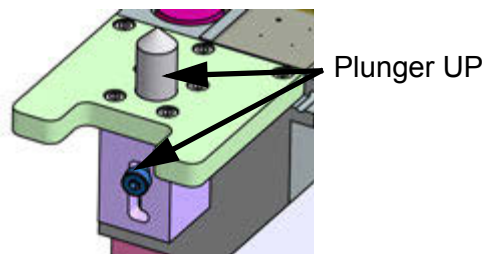

6. Use the Focus slide bar to adjust focus so a clear image displays.
 - If the camera cross hairs remain aligned on the plunger point (Good Alignment), fine tuning is not necessary, continue with [5- Test Alignment](#) (pg 5.21).
 - If the camera cross hairs do NOT remain aligned on the plunger point (Poor Alignment), go to [3\) Fine Tune Perpendicularity](#) (pg 5.21).

Good Alignment
(plunger aligned
with center of cross hairs)

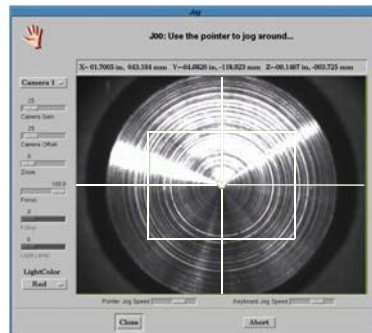

Poor Alignment
(plunger no longer aligned
with center of cross hairs)

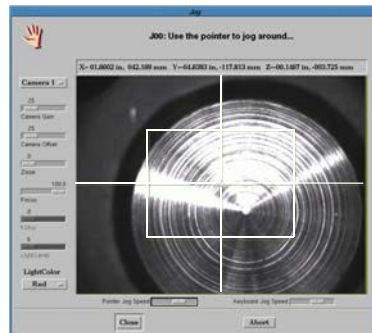

3) Fine Tune Perpendicularity

If fine tuning camera perpendicularity is required:

1. If side-to-side fine adjustments are needed, perform steps 2 through 4 of [Side-to-Side Adjustment](#) (pg 5.15).
2. If front-to-back fine adjustments are needed, perform steps 2 through 4 of [Front-to-Back Adjustment](#) (pg 5.16).
3. Repeat [2\) Prove Perpendicularity](#) (pg 5.20).

5- Test Alignment

When all alignment procedures have been completed, perform these final tests to prove proper alignment has been achieved:

1. Run a single program of a few dots.
2. Verify dot positions using the Full Inspect mode feature.
3. Repeat steps 1 and 2 on the same surface *but at a new surface height*. If the positional accuracy is inconsistent, the perpendicularity of the camera is incorrect. Refer to [Fine Tune Camera Perpendicularity](#) (pg 5.17) for help.
4. Run a program using various Zoom values for fiducial pattern recognition. If Positional accuracy is off, the camera-to-lens adjustment is incorrect. Refer to [3- Camera-to-Lens & Camera-to-Work Area Alignment](#) (pg 5.10) for help.

ADJUST Camera Settings

After the vision system camera has been set up initially, there is generally no need for adjustment, however, if adjustment becomes necessary, refer to the following procedures, keeping in mind that any change to camera or lighting settings could impact your existing programs.



IMPORTANT Adjusting the camera (or lighting) may require changes to all models/patterns used by your programs.

Passive Camera

For instructions on how to adjust the settings, angle, position, or focal point for the passive video camera, refer to:

- *Lens Focus* in the *FLOware Software Guide*
- The data sheet for the Lipstick Camera model installed on your system. A partial list of available data sheets:
 - *Lipstick Camera - Fixed Single Position* (PN 22101376M)
 - *Lipstick Camera - Fixed Dual Station* (PN 22293052M)
 - *Lipstick Camera - Dual Station* (PN 22293035M)
 - *Lipstick Camera - Single & Dual* (PN 22293042M)
 - *Lipstick Camera - Three-Position* (PN 22101346M)

Programmable Camera

For instructions on how to adjust the programmable focus lens camera, refer to the *Adjust Lens Focus Settings* in the *FLOware Software Guide*.

ADJUST Conveyor Belt Tension

Each conveyor belt has an available tension adjustment take-up of approximately 1.25" (3,18 cm). Always adjust BOTH conveyor edge belts.

To adjust conveyor belt tension:

1. [Power Off](#) (pg 3.4) the dispenser.
2. Using an appropriate tool, release belt tension by loosening the hex bolt on the take-up pulley.

MAX Series

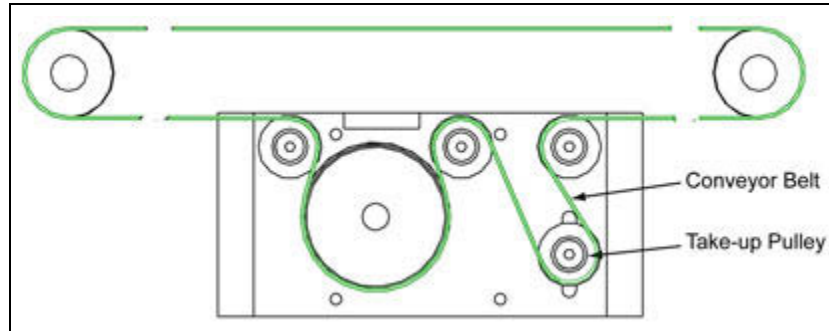

DS Series

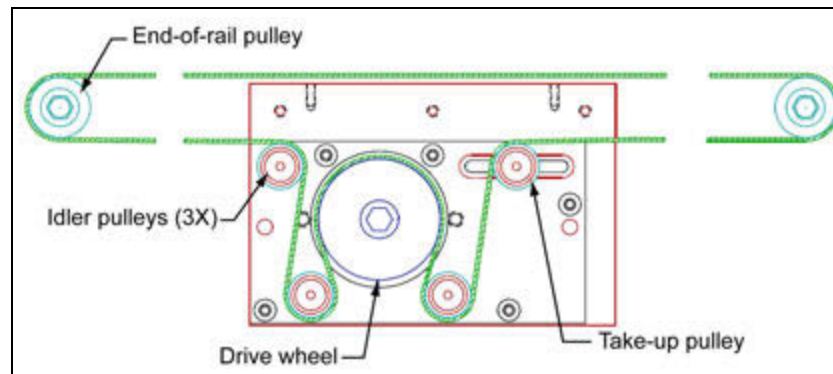

3. As needed, loosen or tighten the belt tension by sliding the take-up pulley toward or away from the machine work envelope.
4. Tighten the hex bolt on the take-up pulley.
5. To re-tension the belt on the other conveyor rail, repeat the above procedure.

ADJUST Conveyor Sensor Sensitivity

There is a sensor, either fiber optic or infrared, mounted on either side of each conveyor stop bar. If a sensor is not sending a good signal, the sensitivity may need adjustment. Sensor amplifiers can be sensitive to ambient light. This condition is especially true for the amplifier at the optional, exit position.

Figure 9: Top View - typical location for conveyor sensor amplifiers at nest position.

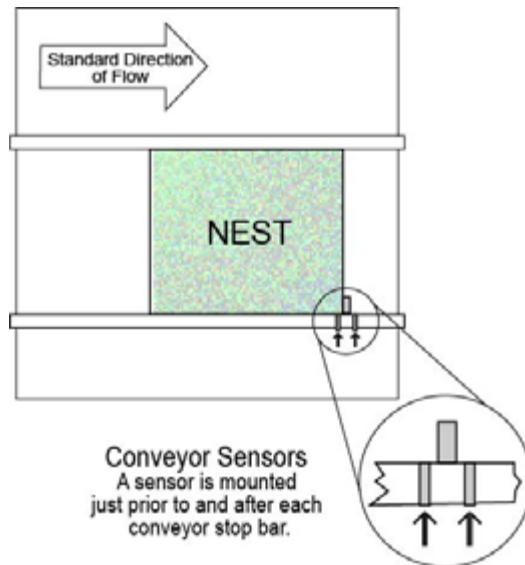

If an amplifier is difficult to tune due to ambient light:

1. Refer to [Conveyor Sensors](#) (pg 8.10) as needed during the following steps.
2. Adjust the position of the sending/receiving unit closer to the product being processed; this will decrease interference due to ambient light.
3. After adjusting its position, tune the amplifier.

ADJUST Conveyor Speeds

There are two variable speeds for the conveyor. Altering either conveyor speed requires setting the appropriate regulator dial, calibration of the new speed value, and then a system reboot.

Figure 10: Conveyor controls are located on the base plate inside rear service panel.

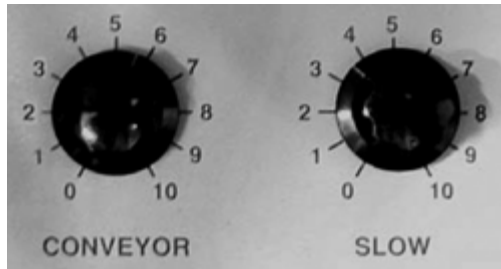

The standard belt speed at which product travels through the dispenser on conveyor belts can be changed to match line speed. The optional slow motion speed can be changed to accommodate process needs as the product approaches and contacts the conveyor stop pin.

Conveyor speed operates in conjunction with Board Length (in Program Editor) to establish successful timing of board transfers between conveyor stop pin positions. If no value is entered in Board Length, boards with slots or holes may fail to be detected.

To adjust either the conveyor speed or conveyor slow motion speed:

1. Open the rear service panel. The conveyor speed controls are mounted on a stand-up plate. The SLOW speed control dial will not be present if the machine is not equipped with the Slow Motion option.
2. With machine power on, adjust the appropriate speed dial.

Table 9: Adjusting Conveyor Speed

Adjustment	Control Dial	Regulates	Adjustment is complete when
belt speed	CONVEYOR	the speed at which product travels through the dispenser.	the speed of the conveyor visually synchronizes with the speed of upstream/downstream conveyors
slow motion (optional)	SLOW	the amount of slowing applied to the speed at which product approaches and contacts conveyor stop pin.	you observe satisfactory results as product approaches the conveyor stop pin.

3. Close the rear service panel.
4. Calibrate the new speed value using the [CALIBRATE Conveyor Speeds](#) (pg 5.46) instructions, and then reboot the system.

NOTE: Failure to calibrate changed conveyor speeds is likely to result in time-out messages and improper stop pin firing times.

ADJUST Conveyor Support & Height

Each time product of a different thickness is to be processed, perform the following procedure. Ideally, product should be evenly supported by the conveyor at the same height as the surface of the calibration station. While product is in the nest area above the lifter plate which is raised during processing, it is important that product be properly supported by the lifter plate support pins and standoffs.

The height at which the lifter plate is set is directly related to product thickness and affects product clearance and stability. In addition, the conveyor upstop rails for DS Series machines must be adjusted and leveled properly as they also affect clearance and stability of the product. switches.



WARNING Use extreme caution when safety shield doors are open. As necessary, open and close the safety shield doors and clear the safety violation condition throughout this procedure.

ADVERTISSE- MENT

Exercez la plus extrême prudence quand les portes de l'écran de protection sont ouvertes. S'il le faut, ouvrez et fermez les portes de l'écran de protection et désamorcez le signal de violation de la sécurité tout au long de cette procédure.

ACHTUNG

Bei offenstehenden Schutzabdeckungstüren müssen Sie mit äußerster Vorsicht vorgehen. Bei Bedarf können Sie die Schutzabdeckungstüren öffnen und schließen und dabei den Sicherheitsverstoßzustand beheben.

AVVERTENZA

Bei offenstehenden Schutzabdeckungstüren müssen Sie mit äußerster Vorsicht vorgehen. Bei Bedarf können Sie die Schutzabdeckungstüren öffnen und schließen und dabei den Sicherheitsverstoßzustand beheben.

ADVERTENCIA

Actúe con extrema cautela cuando las puertas de protección de seguridad estén abiertas. Según sea necesario, abra y cierre las puertas de protección de seguridad y desactive la señal de violación de seguridad durante todo este procedimiento.

To adjust product support and height on a conveyORIZED machine:

1. Jog the gantry to an area out of the way behind the rear conveyor rail.
2. **DS SERIES ONLY.** Using a 7/64" Allen wrench, loosen the lock-down screws in both conveyor upstop rails. The larger lock-down screws secure the upstop rails to the mount rail. The smaller 1/16" set screws control the height of the upstop rails.

Figure 11: Adjusting conveyor upstop rails.

Figure_11: Adjusting conveyor upstop rails.

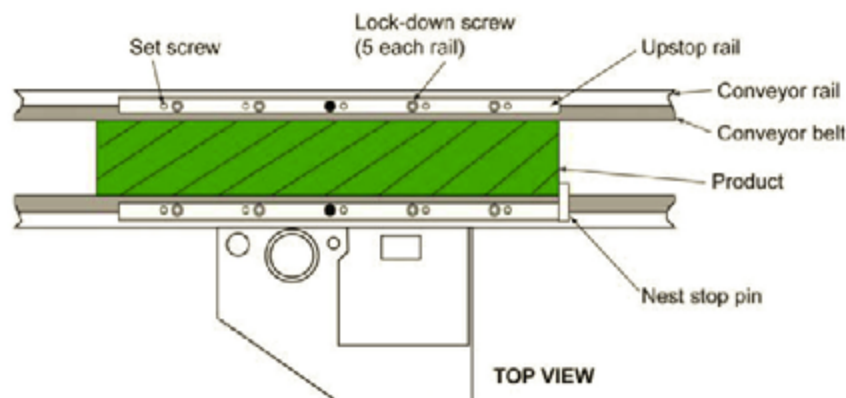

3. Position product by manually sliding it into the nest position and seating it against the nest stop pin.

Figure 12: Product shown positioned in conveyor nest.

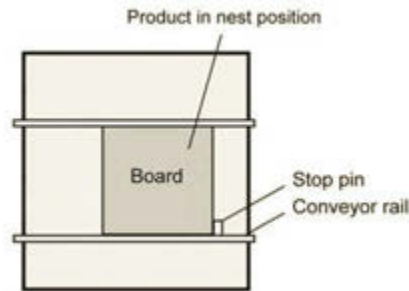

4. Position the various support pins and standoffs that will locate and support the product:

Figure 13: Examples of types of product support.

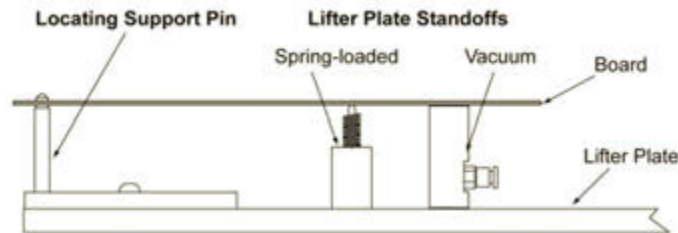

- a. To raise the lifter plate, from the main menu bar click on Machine Controls > Lifter Plate Up. The safety shield(s) must be closed or the lifter plate will not move.
- b. Adjust the support pins and lifter plate standoffs as necessary to support the product satisfactorily.

Table 10: Adjustment by Support Type

Type of Support	Description
Locating Support Pin	Slotted swing-arm and pin device for repeatable, precise product positioning.
Lifter Plate Standoff	Refers to two types of standoffs (vacuum and spring loaded), each with a magnetic base. Provides product support.

5. Adjust the lifter plate vertically to provide clearance and stability for the product:
 - a. Manually slide enough additional product into the nest position to fill the length of the lifter plate; this will help prevent skewing during lifter plate adjustment.
 - b. Loosen the three lifter plate leveling screws.
 - c. Raise the lifter plate by clicking Machine Controls > Lifter Plate Up and inspect the lifter plate surface for proper adjustment relative to the product surface.
 - d. Lower the lifter plate by clicking Machine Controls > Lifter Plate Down and adjust the lifter plate leveling screws as needed.
 - e. Repeat the prior two steps until the lifter plate is adjusted vertically.
 - f. Tighten the three lifter plate leveling screws and re-verify the adjustment.

6. **DS SERIES ONLY.** Adjust the upstop rails vertically to provide clearance and stability for the product:
 - a. Manually slide enough additional product into the nest position to fill the length of the upstop rails; this will help prevent skewing during rail adjustment.
 - b. The lifter plate should be in the raised position. To raise the lifter plate, click on Machine Controls > Lifter Plate Up.
 - c. Raise each upstop rail to its full extent and then adjust them downward until each rail rests on the top side of the product; the rails should contact the product while exerting only minimal pressure.

Figure 14: Upstop rails are positioned relative to board thickness.

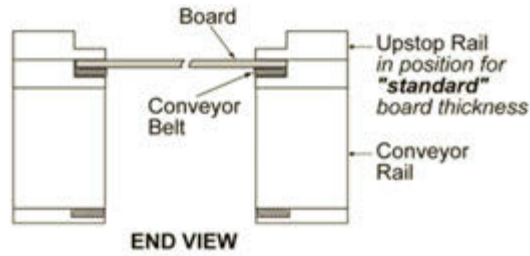
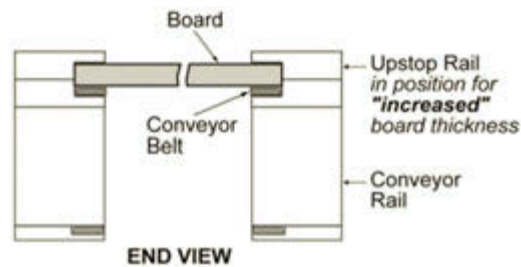
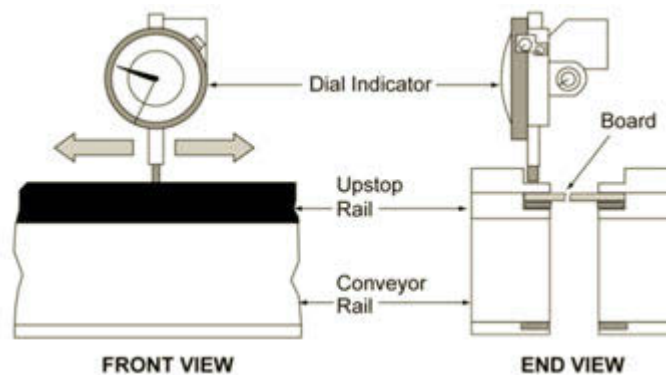

Figure 15: Upstop rails are shown turned over to accommodate a thicker board.



- d. Adjust the lock-down screws and set screws.
7. Lower the lifter plate by clicking Machine Controls > Lifter Plate Down and then remove product from the conveyor. **This is an important step — do not skip it.**
8. **DS SERIES ONLY.** Use the dial indicator from the Setup & Leveling Kit to verify that the upstop rails are parallel to gantry travel:
 - a. Install the dial indicator in mount position 1 per the instructions accompanying the dial indicator.

Figure 16: Position dial indicator to run length of inside top surface of each upstop rail...



- b. Using the Jog function, run the dial indicator down the length of the work area edge for EACH upstop rail.
- c. Make any necessary adjustments with the screws and, when the rails are sufficiently level, lock down the screws and repeat the dial indicator test.
- d. Product should pass freely through the upstop rails, yet be firmly supported:

To further test rail adjustment, manually slide all product back to the entry position and remove all but a single product.

Test product movement through the upstop rails by clicking MOUNT on the main button bar. Product should move to the nest stop pin.

Click MOUNT again. Product should move to the exit position stop pin. As necessary, readjust upstop rails and retest.

9. Conclude procedure:
 - a. Remove product from the conveyor.
 - b. Close the safety shield(s) and clear the safety violation prompt.

ADJUST Conveyor Width

Each time product with a different width is to be processed, perform the following procedure. You can control the width between the conveyor rails either automatically or manually, depending on the model of your dispenser and the type of conveyor adjustment equipment installed.

Automatic Width Adjust

If your dispenser is appropriately equipped and you designate a board width value in a program, the width between the conveyor rails will be adjusted automatically by the program prior to processing the product. When your dispenser is equipped with the Automatic Conveyor Width Adjust feature, a programmable conveyor width adjustment can be associated with a program by way of the Program Editor by entering a value in the Width field and activating the default box associated with that field.

Figure 17: Location of software controls associated with auto width adjust.

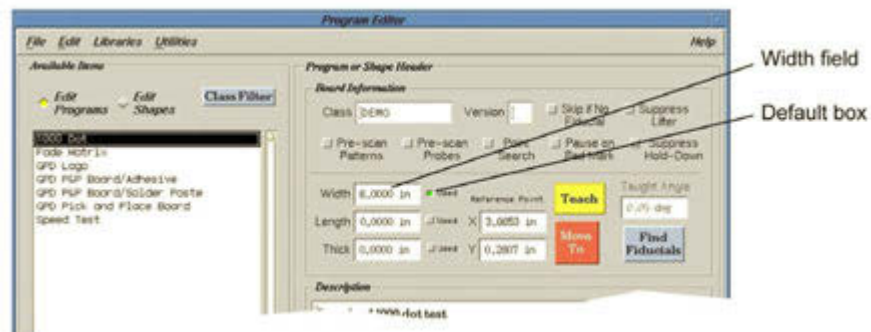

Typical Scenario for Auto Conveyor Width Adjust

1. The operator clicks RUN on the main button bar. The program loads. Board width is determined by the value entered in the Width field (on the Program Editor) for the program loaded.
2. The operator is prompted to clear the area through which the conveyor rails will be moving. If the conveyor rails are already positioned at the width designated in the program, the system will skip prompting the operator to clear the conveyor area.
3. When the operator clicks OK, the conveyor automatically adjusts to the specified width. Product processing then begins.

Manual Width Adjust

Manual width adjust is controlled on DS Series dispensers with a manual hand crank. On MAX Series dispensers, the conveyor can be controlled semi-automatically with a set of switches.

MAX SERIES ONLY

Adjust conveyor width as needed by pressing and holding down the Engage button while pressing the “open” or “close” end of the Open/Close button.

Figure 18: MAX Series “manual” width adjust.

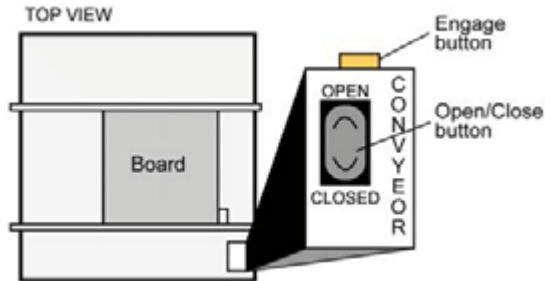

The Open/Close button can only be activated if the Engage button is pressed at the same time (Engage button lights when it is activated). This requirement safeguards against problems that could result from mistakenly locking conveyor in manual mode and running a program with automatic width adjust at the same time.

DS SERIES ONLY

Adjust conveyor width as needed by using the hand crank. Push inward on the hand crank to engage the conveyor rails.

Figure 19: DS Series manual hand crank.

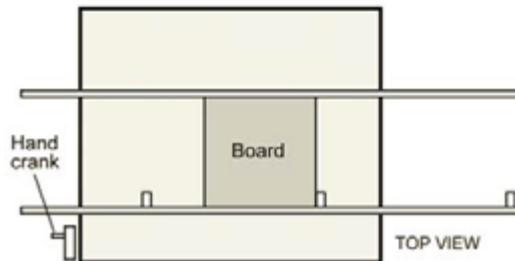

WARNING Use extreme caution when safety shield doors are open. As necessary, open and close the safety shield doors and clear the safety violation condition throughout this procedure.

**ADVERTISSE-
MENT**

Exercez la plus extrême prudence quand les portes de l'écran de protection sont ouvertes. S'il le faut, ouvrez et fermez les portes de l'écran de protection et désamorcez le signal de violation de la sécurité tout au long de cette procédure.

ACHTUNG

Bei offenstehenden Schutzabdeckungsstüren müssen Sie mit äußerster Vorsicht vorgehen. Bei Bedarf können Sie die Schutzabdeckungsstüren öffnen und schließen und dabei den Sicherheitsverstoßzustand beheben.

AVVERTENZA

Bei offenstehenden Schutzabdeckungsstüren müssen Sie mit äußerster Vorsicht vorgehen. Bei Bedarf können Sie die Schutzabdeckungsstüren öffnen und schließen und dabei den Sicherheitsverstoßzustand beheben.

ADVERTENCIA

Actúe con extrema cautela cuando las puertas de protección de seguridad estén abiertas. Según sea necesario, abra y cierre las puertas de protección de seguridad y desactive la señal de violación de seguridad durante todo este procedimiento.



CAUTION Do not manually adjust conveyor width so tightly that the conveyor binds the product.

ATTENTION

Ne pas ajuster manuellement la largeur du convoyeur si étroitement que le convoyeur coince le produit.

VORSICHT!

Die Förderanlage darf nicht so fest mit der Hand eingestellt werden, dass das Produkt blockiert.

ATTENZIONE

Non regolare manualmente l'ampiezza del trasportatore in modo troppo stretto che il trasportatore blocchi il prodotto.

PRECAUCIÓN

No ajuste manualmente el ancho de la transportadora, de forma que quede tan estrecho que la transportadora atasque el producto.

ADJUST Needle Standoff Distance

Establishing the needle standoff distance (board-to-needle tip offset) for the Rigid Needle Standoff is just a matter of setting the micrometer to the desired setting.

To set desired needle standoff distance:

1. First, verify that the Rigid Needle Standoff micrometer has been setup according to the [Adjustable Height Standoff Adapter](#) (pg 5.51) procedure. The tip of the needle should be flush with the tip of the standoff (zero/zero) prior to setting the needle standoff distance.
2. Select desired Needle Travel value from the table below. This value represents the distance the needle will travel between its retracted state and the board.

Table 11: Needle Standoff Distance

Needle Travel	Micrometer Setting *
.0254 mm (.001") =	0.254 mm (.010")
.0508 mm (.002") =	0.508 mm (.020")
.0762 mm (.003") =	0.762 mm (.030")
.1016 mm (.004") =	1.016 mm (.040")
.1270 mm (.005") =	1.270 mm (.050")
.1524 mm (.006") =	1.524 mm (.060")
.1778 mm (.007") =	1.778 mm (.070")

* The Micrometer/Edge ratio is 10:1, .254 mm = .0254 mm (.010 mils = .001 mils). A turn of .010 mils on the Micrometer equals a .001 mil movement of the Standoff.

3. Set the micrometer to the Micrometer Setting value that corresponds to the Needle Travel value you selected in the prior step.

ADJUST Scale Settings & Parameters

Both the configuration settings and the FLOWare software parameters may be changed for the optional, precision weigh scale to better accommodate your process needs.

Adjust/Calibrate Scale Values

WMC24-SH model only: To adjust/calibrate for any difference between the measured value displayed and the true weight (mass) of the sample, use the Scale Weight Kit PN 22213007 and included procedure.

Change Configuration Settings

To change scale configuration settings:

- Calibrate the scale prior to use. This will help ensure accurate results. For details on how to calibrate the scale, refer to [CALIBRATE Scale](#) (pg 5.55).
- *For CP models only:* Change the parameter settings in the scale itself as needed. For details, refer to [SET UP Scale](#) (pg 5.97).

Change Software Parameters

To change scale software parameters:

1. Calibrate the scale prior to use. This will help ensure accurate results. For details on how to calibrate the scale, refer to [CALIBRATE Scale](#) (pg 5.55).
2. Change the software parameters in the FLOWare control software as needed. Refer to the *Scale Set Up Within Software* in the *FLOWare Software Guide*.

ADJUST Scale to Level

This procedure applies to all scale models mounted in GPD Global dispensers. For accurate results, scale operations require the scale surface to be level. The following procedure details how to level the optional, precision scale.

NOTE: After setting up and leveling the dispense machine, the scale, prior to its initial use, should be leveled. You must also level and adjust the scale after moving it to a new location.

To level a scale:

1. Determine which model of scale is present. If your scale is a model WMC24-SH, continue with the following step. For all CP models, skip to [Step 3](#).
2. To gain access to the mounted level, refer to [WMC24-SH Scale Cleaning Procedure](#) (pg 5.67) for details on how to properly remove all items from the scale and put the protective plastic cover in place.
3. To level the scale, use the leveling system on which the scale is mounted. The scale is completely horizontal when the bubble is precisely in the middle of the level window.

NOTE: Not all scales are equipped with a mounted level. If this is the case, use the level from the Set Up & Leveling Kit and position it on the scale housing, NOT on the weighing pan.

4. After making leveling adjustments, tighten all hold-down screws.
5. Carefully lower the draft shield over the scale. Place lid on the draft shield.
6. To set up the scale for operations, refer to [WMC24-SH Scale - Set Up](#) (pg 5.97).

ADJUST Temperature Controller

Adjust Heat - Watlow

This section addresses how to adjust the temperature set point for the optional Watlow temperature controller. To set up a **new** temperature controller, refer to OEM documentation.

To change the variable temperature set point:

1. [Power On](#) (pg 3.1) the dispenser. The temperature controllers power up with the dispenser.
2. Activate the temperature controller within the software by turning on the applicable Lift-TempCtrln input/output in the ioView window.

NOTE: Activation is required to send a control signal which starts the heating process.

3. Locate the temperature controller that controls heat to the option for which you wish to change the temperature set point. All controllers are located inside the left access panel on the rear of the machine.
4. Adjust the temperature set point to desired value:
 - a. Press the ADVANCE key.
 - b. Using the UP and DOWN keys, set a value for temperature set point.
 - c. Press the INFINITY key. This returns you to the “home” display.

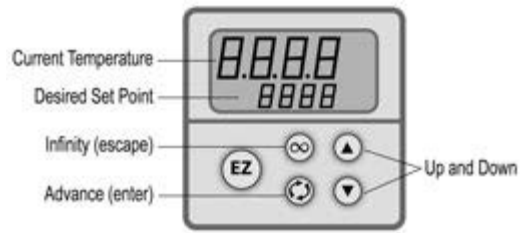

NOTE: If the desired set point displays as a large negative value, this indicates that the controller needs to be activated within the software. Refer to [Step 2](#) above.

Adjust Heat - CAL 9900

This section addresses how to adjust the temperature limit and the temperature displayed for the optional CAL 9900 Temperature Controller. If needed, also perform these procedures:

- To set up a new temperature controller, refer to [Set Up Heat - CAL 9900](#) (pg 5.108).
- To change temperature controller option settings, refer to OEM documentation.

Temperature Limit

The following instructions assume the temperature controller display is showing the current temperature. If the display is showing the functions instead, press the [P] button once and release it. The temperature should now be displayed.

To adjust the set temperature (function 24) for the temperature controller:

1. Press and hold the [*] button.
2. With the [*] button still depressed, press and hold the [↑] or [↓] button until the display shows the new desired set temperature.
3. Once the new temperature is displayed, stop pressing the arrow keys and release the [*] button.

The temperature controller will now maintain the temperature at this new set point.

Displaying Actual Temperature

To adjust the value displayed on the temperature controller to the actual temperature:

1. Press the [P] button once.
2. Press the [↑] button until function 9 displays.
3. Press the [*] button once to change over to option selection.
4. Use the [↑] or [↓] button as needed to enter the adjustment value (in 1° steps +/- 127° maximum). 5. Press the [P] button once.

The temperature controller should now display the value of the actual temperature.

ADJUST Pump Air Pressure

Air pressure to each dispense pump position is controlled through the software. You may set an air pressure value in a program or independent of a program.

Air pressure set independent of a program can be set when no program is running and will override program air pressure values once a program is running.

Figure 20: Popup menu displayed for head position 1.

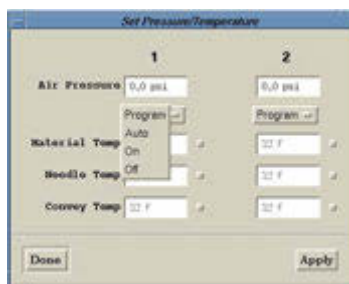

To control pump air pressure:

1. From the main menu bar, click Machine Controls > Set Pressure/Temp. The Set Pressure/ Temperature window displays.
2. From the column for the applicable head position, choose a selection from the pop-up menu based on the following information.

Table 12: Air Pressure Control Choices Defined

Air Pressure Control	Results
Program	Program value is used.
Auto	Program value is used.
On	Overrides program. Air pressure turns on at displayed pressure value and remains on until a different air pressure control selection is made.
Off	Overrides program. Air pressure turns off and remains off until a different air pressure control selection is made.

3. Enter desired air pressure value in the Air Pressure field for the appropriate head position.
4. Click APPLY, and then click DONE to exit the window.

ADJUST Work Area Lifter Plate

The work area for conveyORIZED systems is equipped with a lifter plate to provide a flat surface for fixturing and to present product for processing to a position above the conveyor belts.

Lifter Plate - Upstroke Height

NOTE: The following instructions apply specifically to **Lifter Plate PN 22295050** and may vary slightly for custom lifter plates.

The lifter plate has been factory set to attain a set height. If necessary, the upstroke height of the lift plate can be adjusted. The total adjustment range is 0 to 25 mm.

To adjust the upstroke height, loosen the locking nut on the shock absorber and turn the shock absorber to affect adjustment. Turning the shock absorber counterclockwise increases the upstroke height (moves the plate upward) while clockwise decreases it (moves plate downward).

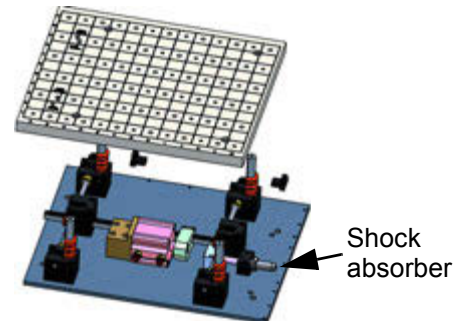

Lifter Plate - Parallel to Gantry Travel

The lifter plate should be parallel to gantry travel. The plate is adjusted at the factory, but if you want to retest and/or adjust for parallelism, follow the procedure below, mounting the dial indicator when instructed to do so.

To test and/or adjust the lifter plate for parallelism:

1. [Power On](#) (pg 3.1) the system per the normal procedure.
2. A prompt to home the system displays. Click OK. The system homes all axes and a series of status messages display during this process. Homing is complete when all homing status messages disappear from the main window.
3. Open the conveyor rail to its maximum range.

Figure 21: Top view of lifter plate 3-point leveling system & zero point reference area.

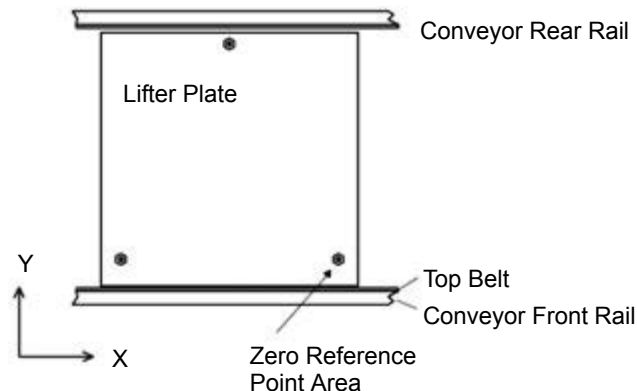

4. Raise the lifter plate by clicking Custom Ctrl's > Lifter Plate Up/Down.
5. Mount the dial indicator per the [Dial Indicator](#) (pg 4.9) instructions.
6. To verify reference point height (for applications NOT using an optional fixture):

NOTE: The front right corner area of the lifter plate is the dial indicator zero (0) reference point for the 3-point leveling system.

- a. Using a scale at the front right corner of the lifter plate, measure the distance between the top surface of the lifter plate and the top surface of the conveyor top belt. The lifter plate surface should be within 1.650" \pm 0.030 (41,91 mm \pm 0,762 mm) of the belt top surface.



IMPORTANT The reference point height specification is the same for both the plate and calibration station and is critical to auto vision dot calibration.

IMPORTANT

Le point de référence de la spécification de hauteur est le même pour la plaque et le poste de calibrage ; il est critique pour visionner automatiquement le calibrage à point.

WICHTIG

Die Referenzpunkthöhe fuer die Platte und die Kalibrierstation ist gleich und kritisch fuer die Auto Vision Dot Kalibration.

IMPORTANTE

Le coordinate di altezza del punto di riferimento sono uguali sulla piastra e sulla stazione di calibrazione ed è importantissimo eseguire la calibrazione in automatico.

IMPORTANTE

La especificación de la altura del punto de referencia es la misma, tanto para la placa como para la estación de calibración y es crítica para la auto calibración por visión de la gota.

- b. Does the reference point height meet the specification?
 - If yes, continue with step 8.
 - If not, continue with step 7.

7. To adjust plate height properly, first determine whether your machine has a heated or non-heated plate, and then follow the applicable procedure.

Table 13: Height Adjustment by Plate Type

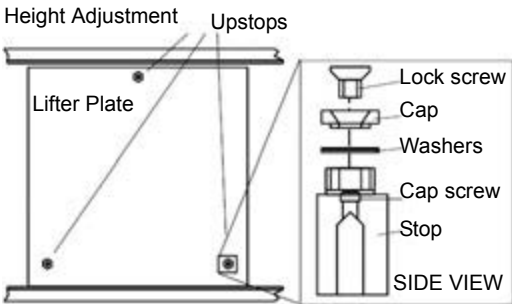
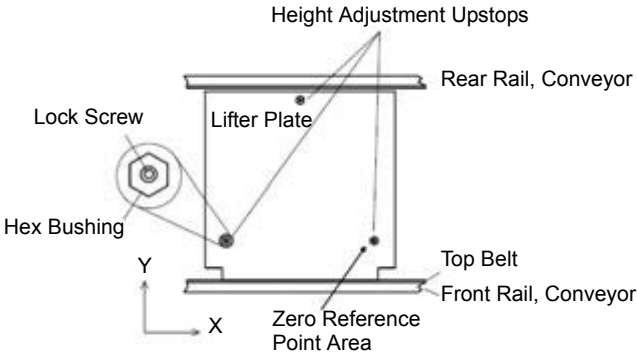
Type of Plate	Adjustment Procedure
Heated	<p>Figure 22: Adjusting heated lifter plate height with height adjustment upstops.</p>  <p>To adjust plate height with the height adjustment upstops:</p> <ol style="list-style-type: none"> Using 7/32" allen wrench, loosen upstop lock screw and remove the screw and cap. Using 1/8" allen wrench, loosen cap screw. Using 9/16" socket wrench, adjust stop as necessary. <ul style="list-style-type: none"> To adjust the plate higher, turn wrench counter-clockwise. To adjust the plate lower, turn wrench clockwise. <p>NOTE: Adjusting plate height requires that you also level the plate.</p> <ol style="list-style-type: none"> Continue with step 8.
Non-heated	<p>Figure 23: Adjusting non-heated lifter plate height with height adjustment upstops.</p>  <p>To adjust plate height with the height adjustment upstops:</p> <ol style="list-style-type: none"> Using 1/8" allen wrench, loosen lock screw on upstop and remove screw. Using 7/8" end wrench, adjust stop as necessary. <ul style="list-style-type: none"> To adjust the plate higher, turn wrench counter-clockwise. To adjust the plate lower, turn wrench clockwise. <p>NOTE: Adjusting plate height requires that you also level the plate.</p> <ol style="list-style-type: none"> Continue with step 8.

8. Level the lifter plate:
 - a. Manually move the gantry to the front right corner of the lifter plate, as close as possible to the height adjustment upstop.
 - b. Manually move the Z axis gantry down until the dial indicator makes contact with the lifter plate surface.
 - c. Set the dial indicator to zero (0).



IMPORTANT The reference point height specification is the same for both the plate and calibration station and is critical to auto vision dot calibration.

IMPORTANT

Le point de référence de la spécification de hauteur est le même pour la plaque et le poste de calibrage ; il est critique pour visionner automatiquement le calibrage à point.

WICHTIG

Die Referenzpunkthöhe fuer die Platte und die Kalibrierstation ist gleich und kritisch fuer die Auto Vision Dot Kalibration.

IMPORTANTE

Le coordinate di altezza del punto di riferimento sono uguali sulla piastra e sulla stazione di calibrazione ed è importantissimo eseguire la calibrazione in automatico.

IMPORTANTE

La especificación de la altura del punto de referencia es la misma, tanto para la placa como para la estación de calibración y es crítica para la auto calibración por visión de la gota.

- d. As necessary, adjust the pertinent upstop(s) to achieve parallelism by first determining whether your machine has a heated or non-heated plate, and then following the applicable procedure:

Table 14: Upstop Adjustment by Plate Type

Type of Plate	Adjustment Procedure
Heated	<p data-bbox="764 1035 1162 1066">Figure 24: Height adjustment upstop.</p> <div data-bbox="852 1102 1079 1354" style="text-align: center;"> <p data-bbox="966 1329 1079 1354">SIDE VIEW</p> </div> <p data-bbox="505 1396 950 1423">To adjust upstop(s) to achieve parallelism:</p> <ol style="list-style-type: none"> <li data-bbox="505 1440 1291 1467">(1) Using a 7/32" allen wrench, loosen the lock screw and remove the cap. <li data-bbox="505 1470 1424 1526">(2) Using a 9/16" socket wrench, adjust the stop as necessary. To adjust the plate higher, turn wrench counter-clockwise. To adjust the plate lower, turn wrench clockwise. <li data-bbox="505 1528 764 1556">(3) Continue with step 9.

Table 14: Upstop Adjustment by Plate Type

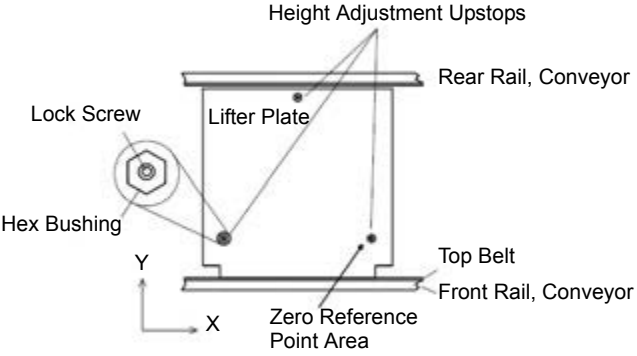
Type of Plate	Adjustment Procedure
Non-heated	<p data-bbox="618 289 1312 317">Figure 25: Adjusting plate height with height adjustment upstops.</p>  <p data-bbox="500 730 1110 758">To adjust plate height with the height adjustment upstops:</p> <ol data-bbox="500 772 1409 888" style="list-style-type: none"> <li data-bbox="500 772 1409 800">(1) Using an 1/8" allen wrench, loosen the upstop's lock screw and remove the screw. <li data-bbox="500 800 1409 856">(2) Using a 7/8" end wrench, adjust the stop as necessary. To adjust the plate higher, turn wrench counter-clockwise. To adjust the plate lower, turn wrench clockwise. <li data-bbox="500 856 764 888">(3) Continue with step 9.

9. When leveling is complete:
 - a. Lock all upstops by tightening lock screws.
 - b. Recheck the dial indicator reading at all three leveling points for a reading of 0 +/- 0.0005" (0 +/- 0,0127 mm). If necessary, repeat the leveling process until all readings meet specification.
 - c. Lower the lifter plate by clicking Custom Ctrl's > Lifter Plate Up/Down.
 - d. Remove the dial indicator.
 - e. Return the conveyor rail to processing position.

Adjusting the lifter plate is complete.

ADJUST Work Area Tooling Plate

The work area for stand alone systems (systems without a conveyor) is equipped with a tooling plate. The tooling plate should be parallel to gantry travel. The plate is adjusted at the factory, but if you want to retest and/or adjust for parallelism, follow the procedure below, mounting the dial indicator when instructed to do so.

To test and/or adjust the tooling plate for parallelism:

1. Jog the gantry to a position out of the way of the tooling plate.
2. [Power Off](#) (pg 3.4) the system per the normal procedure.
3. Mount the dial indicator per [Dial Indicator](#) (pg 4.9) instructions.
4. To verify reference point height (for applications NOT using an optional fixture):

NOTE: The front right corner area of the tooling plate is the dial indicator zero (0) reference point for the plate 3-point leveling system.

- a. Measure the distance between the surface of the table top and the top of the tooling plate using a scale at the front right corner of the tooling plate. The tooling plate surface is factory set to 4" +/- 1/32" (101,60 mm +/- 0,79 mm) above the table top surface.



IMPORTANT The reference point height specification is the same for both the plate and calibration station and is critical to auto vision dot calibration.

IMPORTANT

Le point de référence de la spécification de hauteur est le même pour la plaque et le poste de calibrage ; il est critique pour visionner automatiquement le calibrage à point.

WICHTIG

Die Referenzpunkthöhe fuer die Platte und die Kalibrierstation ist gleich und kritisch fuer die Auto Vision Dot Kalibration.

IMPORTANTE

Le coordinate di altezza del punto di riferimento sono uguali sulla piastra e sulla stazione di calibrazione ed è importantissimo eseguire la calibrazione in automatico.

IMPORTANTE

La especificación de la altura del punto de referencia es la misma, tanto para la placa como para la estación de calibración y es crítica para la auto calibración por visión de la gota.

- b. Does the reference point height meet the specification?

Figure 26: Height adjustment set screws for tooling plate 3-point leveling system.

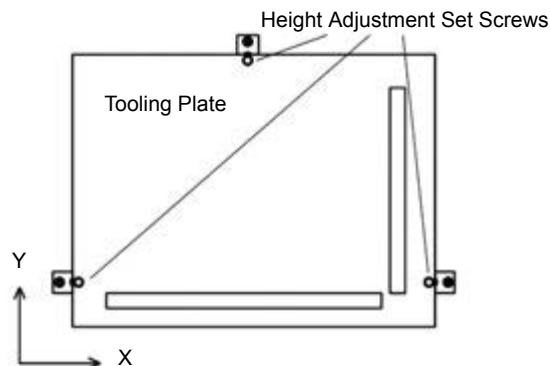

- If yes, continue with step 7.

- If not, use a 3/16" allen wrench to adjust all three height adjustment set screws equally until the height of the zero reference point area meets specification. Adjusting plate height requires that you verify tooling plate parallelism (refer to the following step).
5. Verify tooling plate parallelism:
 - a. Manually move the gantry to the front right corner of the tooling plate, as close as possible to the height adjustment set screw.
 - b. Manually move the Z axis gantry down until the dial indicator makes contact with the tooling plate surface.
 - c. Set the dial indicator to zero (0).
 - d. Manually push/pull the gantry as close as possible to each of the other height adjustment set screws and take a reading. The dial indicator should read $0 \pm 0.0005"$ ($0 \pm 0,0127$ mm) at all three stops.



WARNING DO NOT allow the dial indicator plunger more than .020" (0.51 mm) deflection and avoid all plate holes while moving the gantry. If the plunger falls into a plate hole, damage to the dial indicator may result.

AVERTISSEMENT

NE PAS permettre une déviation supérieure à 0,51 mm (.020 po) du piston du comparateur à cadran et éviter tous les trous de la plaque en déplaçant le chevalet. Si le piston tombe dans un trou de la plaque, le comparateur à cadran pourrait être endommagé.

ACHTUNG

Achten Sie darauf dass der Fuehler der Messuhr nicht um mehr als .020" (0.51 mm) ausgelenkt wird und vermeiden Sie alle Loecher waehrend Sie die Achsen bewegen, andernfalls droht Schaden an der Messuhr.

AVVERTENZA

EVITATE che l'asta del comparatore si fletta per più di 0,020" (0,51 mm) ed evitate i fori sulle piastre nello spostamento della testa. Se l'asta cade in un foro ne può risultare un danno al comparatore stesso.

ADVERTENCIA

Mientras se mueva el eje, evitar que el indicador del émbolo baje más de 0.51 mm y evitar, asimismo, los agujeros de la placa mientras se mueve el eje. Si el émbolo cae dentro de algún agujero, se dañaría el indicador.

- e. Does the dial indicator meet the specification at all three stops?
 - If it does, continue with step 7.
 - If it does not, continue with step 6.

6. Adjust the tooling plate:
 - a. Using a 3/16" allen wrench, unlock each of the three tooling plate side bolts.
 - b. As necessary, use a 3/16" allen wrench to adjust the pertinent set screw(s) to achieve a level plate.
 - c. Lock the three side bolts on the tooling plate.

Figure 27: Height adjustment set screws for tooling plate 3-point leveling system.

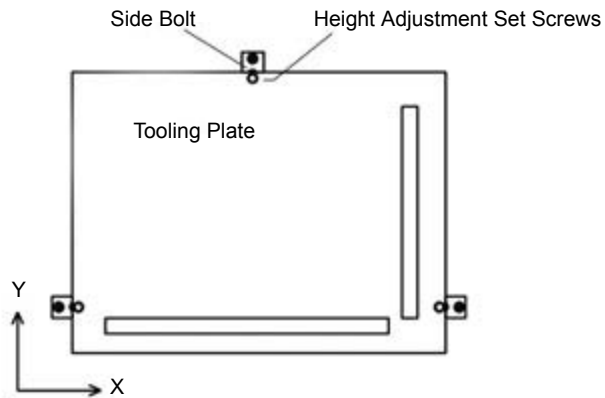

7. When leveling is complete:
 - a. Recheck the dial indicator reading at all three leveling points for a reading of 0 +/- 0.0005" (0 ± 0,0127 mm). If necessary, repeat the leveling process until all readings meet specification.
 - b. Remove the dial indicator.

Tooling plate adjustment is complete.

Calibration Procedures

- [CALIBRATE Conveyor Speeds](#) (pg 5.46)
- [CALIBRATE Conveyor Width](#) (pg 5.50)
- [CALIBRATE Needle Standoff](#) (pg 5.51)
- [CALIBRATE Pick & Place Tool](#) (pg 5.54)
- [CALIBRATE Scale](#) (pg 5.55)

CALIBRATE Conveyor Speeds

To ensure the conveyor operates at the correct rate of speed, perform the following calibration procedure any time a conveyor speed control is changed. Failure to calibrate changed conveyor speeds is likely to result in time-out messages and improper stop pin firing times. The following procedure will instruct you on how to calibrate both the board transit speed and the optional slow transit speed.

To calibrate conveyor speeds:

1. If your machine is equipped with the Slow Sensors option, perform this step; otherwise continue with step 2.
 - a. Click on Configuration > Option Settings.
 - b. Click the CONVEYOR button on the Option Settings window. Conveyor Options displays.
 - c. The Slow Sensors box should appear to be On (red). If it appears to be Off, click the Slow Sensors box once to turn it On.

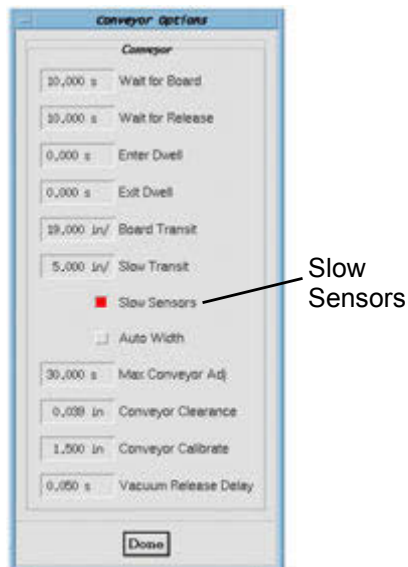

- d. Click DONE.
- e. If a change was made during step 1.c, reboot the system to implement the change.

2. Choose one:

Table 15: Action required based on type of conveyor

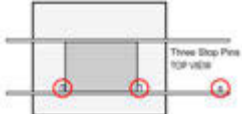
If conveyor is equipped with:	Continue with this step:
Single stop pin at nest area 	Step (pg 5-47)
Three stop pins (one each at entrance, nest, and exit areas). 	Step (pg 5-48)

SINGLE STOP PIN CONVEYOR

Determine the value of Board Transit and, as applicable, the average value of Slow Transit:

- a. Click on Calibration > Calibrate Conveyor Speed. The Conveyor Speed Calibration shell displays. If the stop pin was retracted, it will extend.

NOTE: During the calibration on any system, the moment a board is sensed by the position being tested, the pin will retract and the conveyor will be turned off.

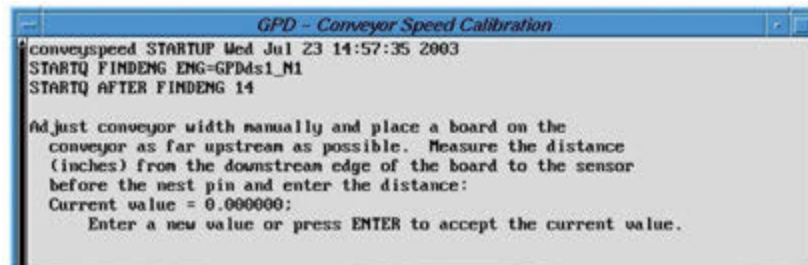

- b. Manually adjust the conveyor width and place a board on the conveyor as far upstream as possible.
- c. Measure the distance (inches) from the downstream edge of the board to the sensor before the nest pin.
- d. Enter the measured distance and press ENTER. The entered distance displays.

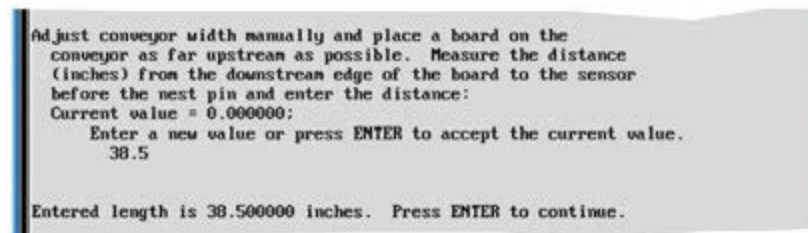

- e. Press ENTER. The value displays for Board Transit and, if applicable, Slow Transit.

```
Board Transit = 12.820513 in/sec. or Board Transit = 325.641023 mm/sec Length =
38.500000 Time = 3.003000

Press ENTER when ready to exit program.
```

- f. Record the value displayed and then press ENTER.
g. Continue with [Step 3 \(pg 5-49\)](#).

THREE STOP PIN CONVEYOR

Determine the value of Board Transit and, as applicable, the average value of Slow Transit:

- a. Click on Calibration > Calibrate Conveyor Speed. The Conveyor Speed Calibration shell displays. If the stop pin was retracted, it will extend.

NOTE: During the calibration on any system, the moment a board is sensed by the position being tested, the pin will retract and the conveyor will be turned off.

```
GPD - Conveyor Speed Calibration

Measure the distance (inches) from the Enter Pin to the sensor
at the exit station. Normal value for a DS9000 is 53.750000,
normal value for a DS9100 is 58.500000.

Current value = 52.781498:
Enter a new value or press ENTER to accept the current value.
```

- b. The travel distance value displayed as "Current value" should match the actual distance a board will travel between the upstream side of the entry stop pin and the upstream side of the sensor at the exit stop pin (see below).

Measure the travel distance in inches and type the resulting value.

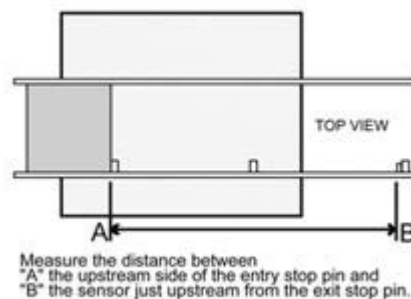

- c. Press ENTER. The following screen update displays.

```
Adjust conveyor width manually and place a board on the
conveyor against the enter pin. Press ENTER when ready.
```

- d. Place a sample board against the entry stop pin and, as needed, adjust conveyor width. Press ENTER to establish the rate of speed for Board Transit. When the board reaches the exit pin, the following screen update displays.

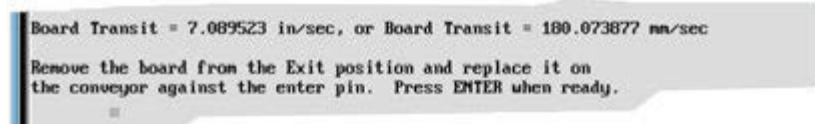

- e. Record the value displayed and then press ENTER.
3. For machines equipped with the Slow Sensors option, perform this step; otherwise, continue with the next step. Retrieve the board, place it against the entry pin again, and press ENTER to establish the rate of speed for Slow Transit. When the board reaches the exit pin, the following screen update displays.

Record the values displayed for Board Transit and, if applicable, record the values for Slow Transit. Press ENTER to close the screen.

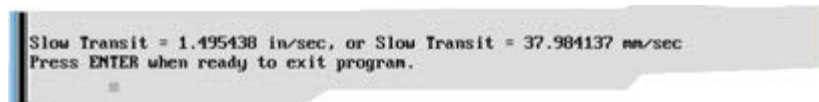

4. Repeat the applicable steps specified below TWO more times. You will use the slowest of the three resulting speed values in the following step.

Table 16: Repeat action required based on type of conveyor

Type of Conveyor	Repeat these steps:
Single stop pin	Step (pg 5-47) and Step 3 (pg 5-49)
Three stop pins	Step (pg 5-48) and Step 4 (pg 5-49)

5. Enter conveyor speed values:
 - a. Click on Configuration > Option Settings. Option Settings displays.
 - b. Click the CONVEYOR button. Conveyor Options displays.
 - c. Enter the slowest of the resulting speed values you recorded for Board Transit and, if applicable, Slow Transit.
6. Click DONE.
7. Reboot the system to implement changes.

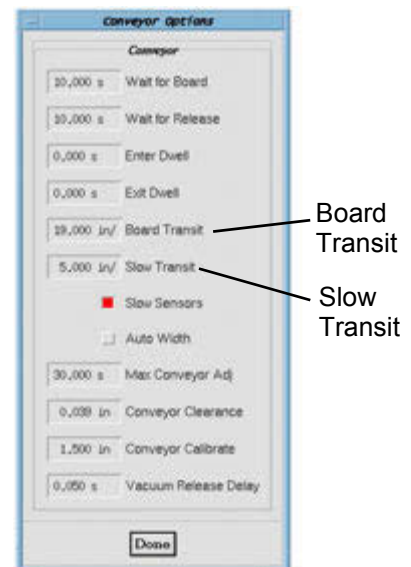

CALIBRATE Conveyor Width



The conveyor, when equipped with automatic conveyor width adjust, requires calibration to achieve proper processing results. Calibrating the conveyor establishes the width between the conveyor rails.

Typically, conveyor width calibration is a one-time process performed at the factory. If, however, you want to re-calibrate the conveyor width, see detailed instructions for *Conveyor Width Calibration* in the *FLOware Software Guide*.

CALIBRATE Needle Standoff

The optional rigid needle standoff is normally used to establish a constant offset between board and needle while dispensing at high speeds on warped boards using minimal height sensing. Calibrating the rigid needle standoff establishes the offset between the standoff foot and the tip of the needle. Select the procedure applicable to the type of rigid needle standoff your equipment uses:

Table 17: Action required based on type of standoff

Type of Standoff	Part No.	Calibration Procedure
	22110125 or 22110155	Adjustable Height Standoff Adapter (pg 5.51)
	22110031	Standoff Adapter (pg 5.52)

Adjustable Height Standoff Adapter

Rigid needle standoff height is easily adjusted with micrometer.

The optional Rigid Needle Standoff establishes a constant offset between the board surface and the tip of the pump needle. Initially, the Rigid Needle Standoff micrometer must be adjusted to zero to ensure an accurate needle standoff setting. Then establishing the board-to-needle tip offset, or needle standoff distance, is just a matter of setting the micrometer to the desired setting.

NOTE: For an exploded view drawing of this option, refer the *LX Auger Pump User Guide*.



To set the micrometer to zero:

1. Select the size of Standoff Zero Set (Item 8) that corresponds to the size of the pump needle: 1/4" or 1/2".

NOTE: The Standoff Feet and Standoff Zero Sets used during the following procedure and supplied with the Rigid Needle Standoff Option come in two standard sizes, 1/4" and 1/2". These parts are intended to be used with 1/4" and 1/2" needles, respectively.

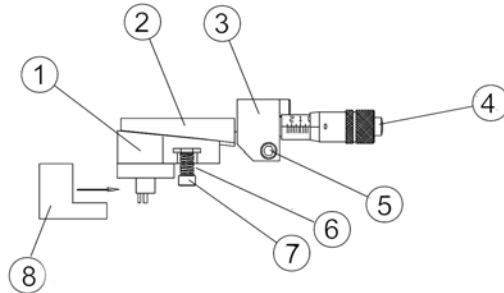

2. Attach the Standoff Zero Set to the Angled Base (Item 1). Verify that the Zero Set covers the ends of both the Standoff Foot and the Needle.
3. Reposition the Wedge:
 - a. Loosen the Socket Head Cap Screw (Item 5) and pull the Wedge/Micrometer unit (Items 2 and 4) back against the Micrometer Block (Item 3).
 - b. Verify that the Micrometer gradients face upward and are set at zero/zero.
 - c. Secure the Micrometer with the Socket Head Cap Screw — DO NOT over tighten.
4. Test to verify that the Wedge moves between the Pump Body and the Angled Base (Item 1). The #4 Washers should be flush with the non-angled side of the Base. This will compress the Spring (Item 6), but there should still be enough "free length" of the spring to operate the Wedge.
5. Bring the Wedge back against the Micrometer Block and verify that the Micrometer is still at zero/zero after the wedge movement verification of the previous step. The Wedge does not necessarily have to be touching the Micrometer Block.
6. Remove the Zero Set. After zero point is set, the Standoff Foot (Item 8) can be rotated to any point without affecting the zero set point.

To set a needle standoff distance, refer to [ADJUST Needle Standoff Distance](#) (pg 5.33).

Standoff Adapter

To calibrate a rigid needle standoff not equipped with a micrometer:

1. Initiate a Run cycle. When the Mounts Table window appears and the gantry has moved to the front of the machine, install the head that will be using the rigid needle standoff.
2. Install the rigid needle standoff in the pump mount, being careful not to bend the needle.
3. Reposition the needle above the tip of the rigid needle standoff foot by loosening the head mount screw, sliding the head upward until the tip of the needle is above the bottom of the standoff foot, and then re-tightening the head mount screw.



4. Position the rigid needle standoff foot as specified by your process engineer. The foot can be rotated by loosening the set screw(s) in the side of the standoff, rotating the foot into the desired position, and then tightening the set screw(s).

NOTE: The rigid needle standoff foot must conform with the X Standoff Offset and Y Standoff Offset in the Heads table or else improper calibration will result.

5. Verify that the micrometer is set to zero (0) or flush with the micrometer mount.
6. Resume the calibration process by clicking CONTINUE. The rigid needle standoff foot height will be established during the calibration sequence.
7. When the rigid needle standoff foot stops at the micrometer mount surface, adjust the micrometer to the desired offset value.
8. While supporting the head with one hand, loosen the head mount screw with the other hand; slowly lower the head until the needle tip rests on the micrometer; and then tighten the head mount screw.
9. Click CONTINUE to resume the calibration process.

NOTE: The program Start Z value is overridden by the Standoff value (in the Heads library). To change the Standoff value, which is normally a negative number, continue with the Valve/Tool Editor by clicking on Editor > Libraries > Head, select the appropriate pump, and enter the new value in the Stand Off field that will compensate for board warping.

CALIBRATE Pick & Place Tool

The values of the X Offset and Y Offset are critical to the calibration of a pick & place vacuum tool. These values are factory set, however, if it becomes necessary to modify either of these values, use of the head calibration tool from the Setup & Leveling Kit is required.

To calibrate a pick & place tool:

1. To determine the X Offset and Y Offset values, measure the difference between the center line of the pickup point of the pick & place tool and the mount surface of the head calibration tool.

The X and Y values may be small, but they are very significant for accurate pick-and-place operations.

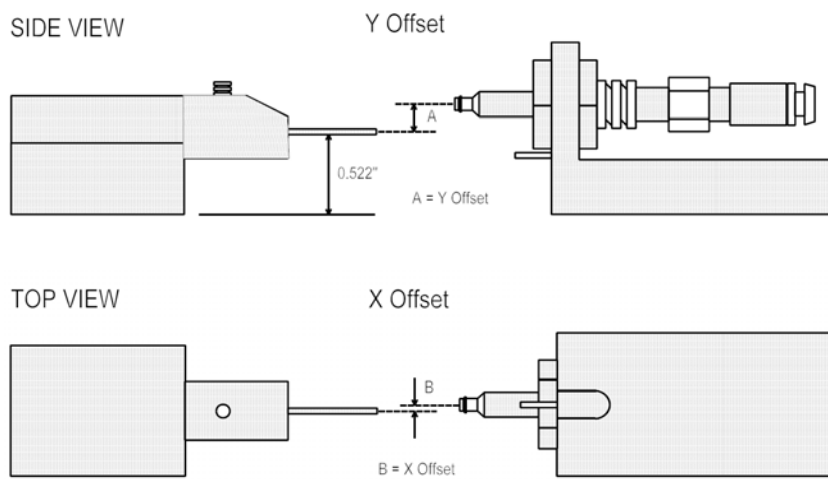

2. Open the Valve/Tool Editor window by clicking Editor > Libraries > Head.
3. Select the pick & place tool.
4. Enter the new values in the X Offset and Y Offset fields.
5. Click APPLY and CLOSE.

CALIBRATE Scale

Your scale was calibrated at the factory; however, it is necessary to calibrate upon setup and then on a regular basis thereafter. Calibration frequency using the maximum permissible weight standard depends on usage, application, and ambient conditions (temperature, static, humidity, etc.).



IMPORTANT The scale must be professionally certified and calibrated whenever it is moved

IMPORTANT

La balance doit être calibrée et certifiée par un professionnel chaque fois qu'elle est déplacée.

WICHTIG

Die Waage muss professionell zertifiziert und kalibriert werden, wenn sie bewegt wurde.

IMPORTANTE

La bilancia deve essere certificata da un professionista e calibrata ogniqualvolta venga spostata.

IMPORTANTE

La escala ha de ser calibrada y certificada profesionalmente, cada vez que se la mueva.

WMC24-SH Scale - Adjust/Calibrate

To correct any difference between the measured value displayed and the true weight (mass) of a sample, GPD Global suggests using the Scale Weight Kit PN 22213007 and included procedure. With the included display terminal, the kit enables you to change the displayed output to match a certified weigh unit (at a specified temperature).

CP Scale - Adjust/Calibrate

GPD Global suggests using the 4 Place Scale Calibration Kit PN 22291075 during the [scale Calibration Procedure](#) (pg 5.57).

Calibration is the determination of the difference between the weight readout and the true weight (mass) of a sample. Calibration does not entail making any changes within the scale.

Adjustment is the correction of any difference between the measured value displayed and the true weight (mass) of the sample, or the reduction of the difference to an allowable level within the maximum permissible error limits.

Calibration/adjustment can be performed only:

- when there is no load on the scale,
- when the scale is tared,
- when the internal signal is stable.

If these conditions are not met, an error message is displayed (Err 02).

Adjustment can be performed:

- automatically following calibration (menu code 1 10 1) or
- manually, at operator discretion, after calibration (1 10 2).

The weight displayed for sample on scale must not differ from nominal weight by more than 2%.

Use any of the following weight units to calibrate/adjust: g, kg, lb (1 11 1 to 3).

You can block calibration/adjustment of the scale:

- Select menu code 1 9 7, and
- Close menu access switch on back of scale.

You can have the calibration/adjustment results documented in a ISO/GLP-compliant printout.

Calibration/Adjustment Sequence

You can configure the operating menu so that:

- adjustment automatically follows calibration in a single operation (1 10 1), or
- the operator chooses whether to end the calibration/adjustment routine or have adjustment performed (1 10 2).

If there is no deviation, or if the difference is within the effective requirements for accuracy of measurements, it is not necessary to adjust the scale. In this case, you can end the calibration routine following calibration. Two keys are active:

- CAL = start adjustment
- CF = end the calibration/adjustment routine.

Factory Settings

Calibration/adjustment mode for models without built-in motorized calibration weight: External calibration (1 9 1)

Calibration/adjustment mode for models with built-in motorized calibration weight: Internal calibration (1 9 3)

Calibration/adjustment sequence: Adjustment automatically follows calibration in a single operation (1 10 1).







Weight unit for calibration: Grams (1 11 1)

ISO/GLP - compliant printout: Off (8 10 1)

Calibration Procedure

NOTE: After initial power-up, the scale requires a minimum of 30 minutes to reach its required operating temperature.

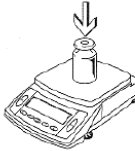
NOTE: GPD Global suggests using the 4 Place Scale Calibration Kit PN 22291075 during the following calibration procedure.

Step	Key (or instruction)	Display/Printout
1. Turn on the balance/scale, if necessary.		0.0 g
2. Tare the balance/scale, if necessary.		0.0 g
3. Start calibration/adjustment Calibration weight is displayed without a unit symbol.		+5000.0 g CAL 
4. Apply the prompted calibration weight (in this example: 5000 g).		
5. Balance/scale is calibrated (displayed only if menu code <i>i i0 2</i> is set).		- 0.2 g CAL ± 
6. If the menu code for "calibration and adjustment in a single step" (<i>i i0 i</i>) is set, the balance/scale is now adjusted automatically.		Adjust CAL
7. At this point, adjustment is completed.		[[CAL
8. After calibration, the weight unit is shown.		+ 5000.0 g CAL
9. Remove the calibration weight.		0.0 g

Cleaning Procedures

- [CLEAN Calibration Station](#) (pg 5.58)
- [CLEAN Camera Lamp Diffuser](#) (pg 5.60)
- [CLEAN Camera Lens](#) (pg 5.60)
- [CLEAN Camera Multi-Axis Lights](#) (pg 5.61)
- [CLEAN Filter in Door](#) (pg 5.62)
- [CLEAN Needle](#) (pg 5.63)
- [CLEAN Needle Cleaner](#) (pg 5.64)
- [CLEAN Needle Offline with Needle Cleaner](#) (pg 5.65)
- [CLEAN Needle Online with Needle Cleaner](#) (pg 5.66)
- [CLEAN Scale](#) (pg 5.67)
- [CLEAN Touch Pad](#) (pg 5.69)
- [CLEAN Touch Probe](#) (pg 5.70)
- [Cleaning Pumps](#) (pg 5.71)

CLEAN Calibration Station

To clean the compact model of calibration station and/or replace the paper roll, step through all of the following procedures.

Remove Module

To remove the paper/ceramic chip Module from the calibration station:

1. Loosen the Lock Knob by turning it counterclockwise.
2. Lift the Module away from the calibration station Base.

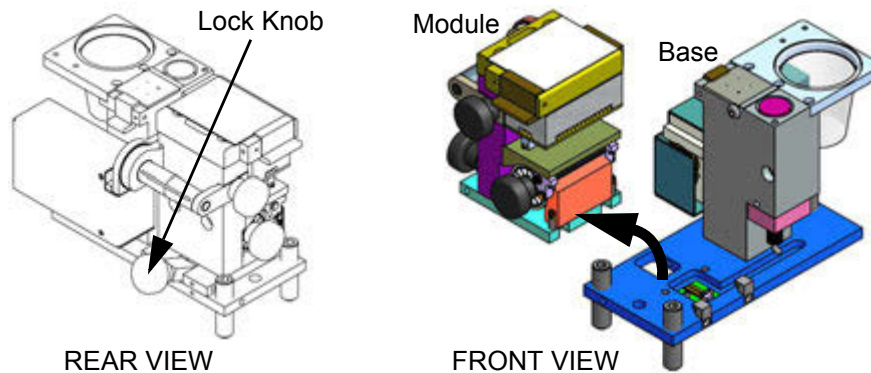

Disassemble Paper Feed

To disassemble the paper feed portion of the Module:

1. Unscrew, remove, and set aside the Paper Knob. The paper roll is revealed.
2. Slide the paper roll off its spindle.

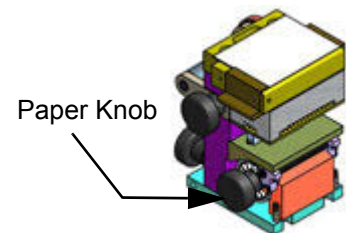

Clean Calibration Station

1. Clean both the Module and rest of the calibration station with low pressure, contaminant-free compressed air.
2. Then wipe all surfaces clean with a soft, clean cloth and either isopropyl alcohol or acetone - whichever solvent is compatible with the dispense material to be cleaned from the calibration station.

Change Paper Roll

1. Slide a new paper roll onto the paper spindle, feeding the paper end through the Slot.
2. Screw the Paper Knob back in place.
3. Finish feeding the paper end up and over the ceramic chip area into the Paper Take-up Reel.
4. Tighten paper tension by manually turning the Paper Take up Reel.

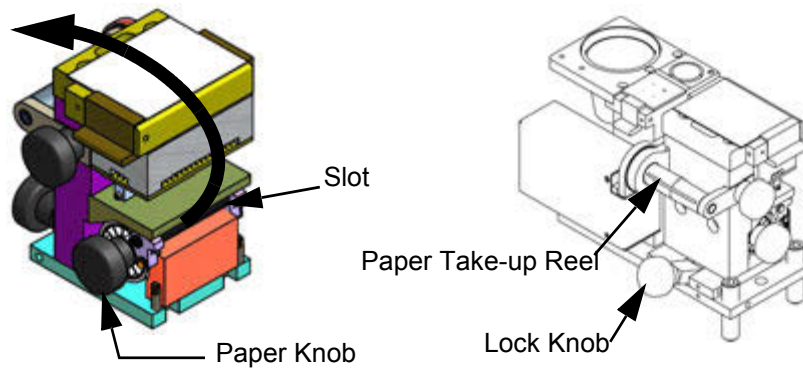

Reinstall Module

To reinstall the paper/ceramic chip Module in the calibration station:

1. Carefully slide the paper/ceramic chip Module so it is seated in calibration station base.
2. Lift and tighten the Lock Knob.
3. Grasp the Module and verify that it is securely locked in place. If necessary, loosen Lock Knob, reseat Module, and then resecure Lock Knob.

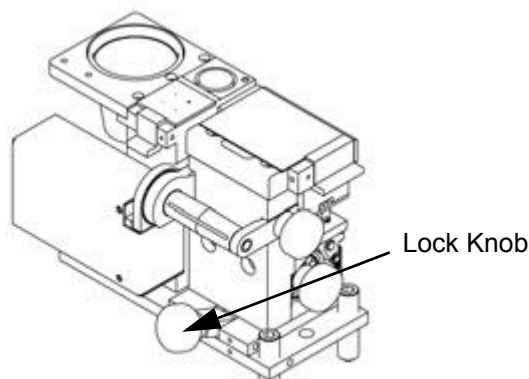

CLEAN Camera Lamp Diffuser

The lamp diffuser (slanted surface) must be cleaned whenever dust or other contaminant build up decreases light intensity.

CAUTION: These components are susceptible to breakage, displacement and scratching if not treated with care. All cleaning agents and materials used must be lint and abrasive free and suitable for use on plastic and/or glass.

1. First, clean these components with low pressure, contaminant-free compressed air.
2. When additional cleaning of glass components is needed, use a cleaning fluid suitable for glass and wipe with a lint and abrasive free cloth.
3. When additional cleaning of plastic components is needed, "fog" the component with your breath and wipe with a lint and abrasive free cloth.
4. If spots are evident after cleaning, wipe with a cotton or foam tipped swab moistened with alcohol and blow dry with low pressure, contaminant-free compressed air.

Clean Housings - Housings for the illuminator, controller, and power supply should be cleaned by buffing with a dry, lint-free cloth whenever a build up of dust or other contaminants is noticeable.



CLEAN Camera Lens

A special coating has been applied to the lens surface to prevent light reflection. Whenever the camera lens is found to be dirty, clean as instructed below. A dirty lens surface due to dust, oil, or finger print causes harmful flare which results in degenerating lens property. Dirt on the lens may also gather molds or scorch on the lens.

NOTE: Be careful not to damage the lens surface while cleaning it.

Removing Dust

To remove dust from the camera lens, use an oil-free soft brush or a blower-brush (for photography use) to gently brush all dust and debris from the lens.

Removing Oil or Water

To remove oil or water from the camera lens:

1. Using a soft clean cloth, wipe off oil or water drops to dry the lens surface.
2. Prepare an oil-free and washed-out cotton cloth or lens cleaning paper with either alcohol, benzene, or lens cleaning liquid.
3. Gently wipe any remaining dust and/or debris by moving spirally from the lens center toward its rim.
4. Repeat wiping with another wet cloth or paper until the lens is completely clean.

CLEAN Camera Multi-Axis Lights

The Multi-Axis Illumination option (p/n 22293025) provides the system with selectable types of illumination. For details on how to select types and colors of illumination, refer to *Lighting Controls* in the *FLOware Software Guide*.

Guidelines & Specifications

- Do not expose lighting surfaces to liquid splash or spray.
- Protect lighting surfaces from fine-particle conductive contaminants (e.g. metallic dust from milling operations).
- Environmental Specifications:
 - Operating humidity, maximum 95% non-condensing
 - Operating temperature . . . 40 degrees C (104 degrees F)
 - Storage temperature . . . 50 degrees C (122 degrees F)
- Illumination & Electrical Specifications:
 - Light aperture... 50 mm x 50 mm (2 in. X 2 in.)
 - Field of view x stand-off. 25.4 mm x 139.77 mm (1 in. X 5.5 in.)

Cleaning Light Surfaces

To clean the lighting surfaces of the Multi-Axis Illumination option:

1. Clean by buffing with a dry, lint-free cloth whenever a build up of dust or other contaminants is noticeable.
2. Clean whenever dust or other contaminant build up decreases light intensity.

NOTE: Lighting surfaces are susceptible to breakage, displacement, and scratching if not treated with care. All cleaning agents and materials used must be lint and abrasive free and suitable for use on plastic and/or glass. First, clean components with low pressure, contaminant-free compressed air (Miller-Stephenson Aero-Duster or equivalent).

- When additional cleaning of glass components is needed, use Miller-Stephenson Cleaner (or equivalent) for glass, plastic, or metal and wipe with a lint and abrasive-free cloth.
 - When additional cleaning of plastic components is needed, “fog” the component with your breath and wipe with a lint and abrasive-free cloth.
 - If spots are evident after cleaning, wipe with a cotton or foam-tipped swab moistened with alcohol and blow dry with low pressure, contaminant-free compressed air.
3. Fan foam filters should be removed and cleaned by using compressed air or a vacuum cleaner whenever a build-up of dust or other contaminants is noticeable or at 30 day intervals. Extremely dirty filters may require washing with water and mild detergent. Dry thoroughly before reinstalling filter.
 4. If present, cooling fins (heat sinks) should be cleaned by using a soft bristle brush, compressed air or a vacuum cleaner whenever a build-up of dust or other contaminants is noticeable or at 30 day intervals.

CLEAN Filter in Door

MAX SERIES ONLY

A filter strip is located inside the bottom lip of the front right door of the dispenser to help guard the machine interior from dust and debris. To clean the filter, remove it from the door and blow it clean with a pressurized air line.

INTERVAL: Every 3 - 6 months

CLEAN Needle

If a needle becomes clogged, either remove and clean it, as described below, or use the optional [CLEAN Needle Offline with Needle Cleaner](#) (pg 5.65).

Clean a Needle

To remove and clean a needle:

1. Turn off the syringe air pressure for the applicable pump mount position, and remove the air adapter from the pump assembly.
2. To remove the needle from the pump:
 - a. Disconnect the pump's power cord from the power/air distribution panel.
 - b. Loosen and remove needle from base of the pump by loosening attachment screws.
3. Clean most needles using one of the following methods. To clean a Micro-Dot pump needle, refer to the *Micro-Dot Pump Guide*.

NOTE: DO NOT clean a needle with fibrous cloths, swabs, "pipe cleaners", or other objects which tend to leave filaments behind. Small filaments will clog the needle and render it useless.

NOTE: DO NOT use high temperature bath. High temperatures may cure material in needle.

NOTE: DO NOT leave adhesives in a needle overnight. Adhesives will either cure or begin to gum in the needle, making it nearly impossible to clean.

Remove Material from Needle

1. Perform the preceding Clean a Needle procedure.
2. If the needle is full of material, use a metal object (small screwdriver or metal rod) to remove the excess. DO NOT use fibrous cloth to remove excess material.
3. Fill the needle cylinder with isopropyl alcohol or cleaning agent free of lubricants.
4. Cover the needle with a cloth to catch the spray.
5. Attach the needle cylinder to an air nozzle supplied with clean, dry shop air. Remove the air nozzle when the needle blows clean air.
6. Reattach the needle to pump base.
7. Reattach the air adaptor and power cord.

If the needle is not effectively unclogged, replace it with a new needle.

Using Purge Compound

1. Perform the above Clean a Needle procedure.
2. Immediately after removing the needle from a material syringe, screw it on the end of a purge compound syringe.
3. Apply 8 to 12 pounds of air pressure until purge compound dispenses from the needle tip. When the needle is reused, the purge compound will be cleaned out during the purge process at the calibration station.

If the needle is not effectively unclogged, replace it with a new needle.

CLEAN Needle Cleaner

The optional, software-controlled Grip Type Needle Cleaner can be used to clean a needle during the calibration process, any time during a program run, or offline when the dispenser is not busy.

Periodically, the disposable jaws (and for older wipe-patch models, the wipe patches) need to be cleaned or replaced.

The frequency of cleaning and replacement is dependent on your process and dispense materials.

Figure 28: One jaw shown removed and disassembled from each model.



Cleaning the Needle Cleaner

To clean or replace the disposable jaw parts, use Needle Cleaner Kit PN 22290036.

1. Remove a jaw:
 - *Magnetic Model only:* Pull jaw away from magnetic gripper fingers.
 - *Multi-Wipe & Wipe Patch Models:* Firmly pull jaw firmly and straight upward off the dowel pins that hold it in place.
2. *Wipe Patch Model only:* Remove wipe patch by pulling out the bead cord on either side of the jaw base.
3. Clean the soft jaw with acetone if acetone is compatible with the dispense material to be cleaned from the jaw, or remove the soft jaw and its adhesive backing and replace with a new soft jaw.
4. *Wipe Patch Model only:* Place a new wipe patch over the soft jaw and secure it in place with a bead cord on either side of the jaw base.
5. Clean the drip pan, then return it to the needle cleaner.
6. Install a jaw:
 - *Magnetic Model only:* Place jaw in magnetic gripper fingers and align jaw so it is flush with finger edges.
 - *Multi-Wipe & Wipe Patch Models:* Position the jaw over the needle cleaner dowel pins and firmly press the jaw down until it is seated on the pins.
7. Repeat the above process for the other jaw.

CLEAN Needle Offline with Needle Cleaner

When a dispenser is equipped with a needle cleaner, needles can be cleaned offline after a purge, a dispense, or a run. Simply select the head to be cleaned and then click the APPLY and CLEAN buttons in the same window.

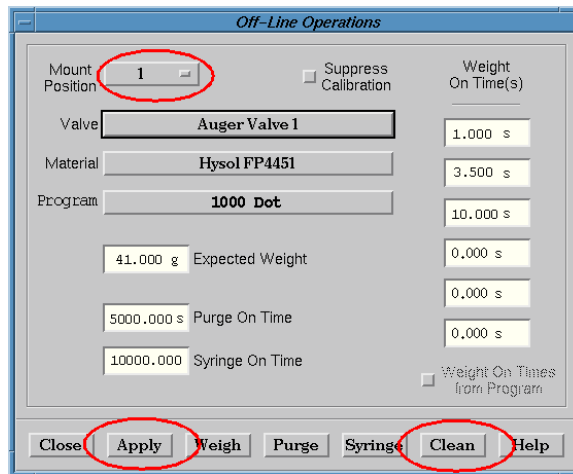

Clean Needle Offline

To clean a needle without running a program:

1. Click on Machine Controls > Offline Operations. The Off-Line Operations window displays.
2. Select the MOUNT POSITION with a needle to be cleaned.
3. Click APPLY.
4. Click CLEAN. The system locates the tip of the needle at the calibration station and then cleans the specified needle at the needle cleaner device. When the needle cleaning process is complete, the system moves to the safety location.

If the system displays a prompt for the operator to clean the needle rather than performing an automatic needle cleaning, then the needle cleaner feature may need to be activated. For details, refer to the [Turn Needle Cleaner On & Off](#) (pg 5.66).

NOTE: If after activating the needle cleaner, the expected needle cleaning process still does not occur, the needle cleaner may not be set up properly. For details, refer to the *Needle Clean & Purge* in the *FLOware Software Guide*.

CLEAN Needle Online with Needle Cleaner

When one or multiple optional needle cleaners are installed and activated (Auto Clean is turned on), a needle can be cleaned automatically as part of a program run, i.e. online. When a needle cleaner is deactivated (Auto Clean is turned off), the system will stop when appropriate and wait for the operator to clean the needle before continuing with normal operations. Turning Auto Clean on and off, i.e., activating and deactivating the needle cleaner function, is a simple matter of clicking several buttons.

You may control the needle cleaner by turning the Auto Clean field on/off either from within a material or from within a program. The Auto Clean function within a program overrides the Auto Clean function within the material used by that same program.

Turn Needle Cleaner On & Off

When the needle cleaner is turned on, the **Auto Clean** field in the Mounts/Material Editor window appears as an indented, red box. When the needle cleaner is turned off, the Auto Clean field appears as a raised, light blue box.

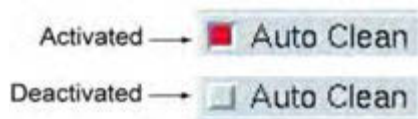

NOTE: Auto Clean is only functional when a needle cleaner is installed on the dispenser and properly configured; otherwise this field is greyed out.

Program & Material Levels

Choose from these activation choices:

- Activate the needle cleaner at the program level to make Auto Clean active only for that particular program.
- Activate the needle cleaner at the material level to make Auto Clean the default in every program using that material.

Table 18: Activating Auto Clean at Different Levels

PROGRAM Level	MATERIAL Level
<p>Using Auto Clean at the program level overrides the default setting at the material level, i.e., the Auto Clean setting in the material used by the program.</p> <p>To turn a needle cleaner on/off in a program:</p> <ol style="list-style-type: none"> 1. From the Program Editor, click VALVE/TOOL MOUNTS. The Mounts/Material Editor- MOUNT window displays. 2. Turn the AUTO CLEAN field on/off to enable/disable the needle cleaner for the selected pump. 3. Click APPLY and then click DONE. 	<p>The Auto Clean setting within the material can be overridden within each program using that material.</p> <p>To turn a needle cleaner on/off in a material:</p> <ol style="list-style-type: none"> 1. From the Program Editor, click Libraries > Materials. The Mounts/Material Editor- MATERIAL window displays. 2. Select desired material. 3. Turn the AUTO CLEAN field on/off to enable/disable the needle cleaner for the selected material. 4. Click APPLY and then click CLOSE.

CLEAN Scale

The optimum maintenance interval for an optional precision scale depends on the operating conditions at the place of installation and on individual tolerance requirements. To ensure that your scale remains reliable, accurate, and functional, the individual components must be cleaned and maintained periodically as appropriate for the intensity of use and the risk of contamination with debris.

Select the procedure applicable to the type of precision scale your dispenser uses.

- [WMC24-SH Scale Cleaning Procedure](#) (pg 5.67)
- [CP Scale Cleaning Guidelines](#) (pg 5.68)

WMC24-SH Scale Cleaning Procedure

To clean a WMC24-SH scale:

1. With a damp cloth, remove all observed debris from the exterior of the draft shield and draft shield lid.

 **CAUTION** To prevent damage to the internal structure of the scale, avoid the use of compressed air or any other means of removing debris that may cause debris to enter the scale.



Draft shield

2. If the scale housing (inside the draft shield) requires cleaning:
 - a. Remove the **lid** from the draft shield and set it aside.
 - b. If a Purge Cup (G) is present on the scale, remove it. If a Purge Cup Support (F) is present, carefully lift it upward and away from the scale without exerting any torque on the Weighing Pan Support on which the Purge Cup Support rests.

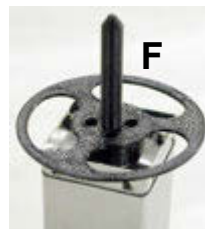
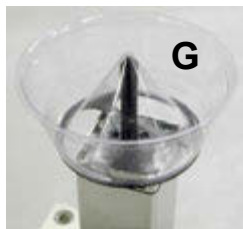

- c. Place the white, protective plastic Cover (B) that came with the scale on the Weighing Pan Support (A) to prevent moisture and debris from entering the internal portion of the scale.

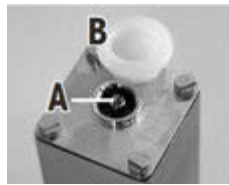

Protective Cover (B) in place.

- d. If removing the Draft Shield is necessary, carefully unbolt the shield at its base, and then carefully lift the shield and its internal insulation panels without contacting the scale and set aside.
- e. Wipe the scale housing with a damp cloth. For tougher debris, a mild household cleaner may be used - make sure no liquid penetrates inside the components.



CAUTION To prevent damage to the internal structure of the scale, avoid the use of compressed air or any other means of removing debris that may cause debris to enter the scale.



CAUTION Never use cleansers containing solvents or gritty scrubbing particles. They could damage or scratch certain surfaces.

- f. Return the scale to production by reversing the previous steps. When bolting the Draft Shield in place, position it to provide clearance on all sides of the Purge Cup position.

CP Scale Cleaning Guidelines

- Disconnect electrical power from the scale prior to cleaning it. If an interface cable is connected to the scale port, unplug it from the port.
- Do not immerse the scale in any liquid.
- Do not use chemical solvents or any other aggressive cleaning agents for cleaning.
- Before using any cleaning or decontamination methods, except those recommended by the manufacturer, verify with the manufacturer that the proposed method will not damage the equipment.
- Clean the scale using a soft cloth that has been made wet with mild soap or diluted bleach (9 parts water to 1 part bleach).
- After cleaning, wipe down the scale with a soft, dry cloth.



CAUTION There are no user serviceable parts within the scale unit. Any attempt by untrained persons to perform repairs may lead to hazards for the user.

CLEAN Touch Pad

It is important to keep the calibration station touch pad clean and free of debris buildup so the needle Z position calibrates properly.

Figure 29: TOP VIEW of Compact Model (left) & Model prior to 2010 (right)

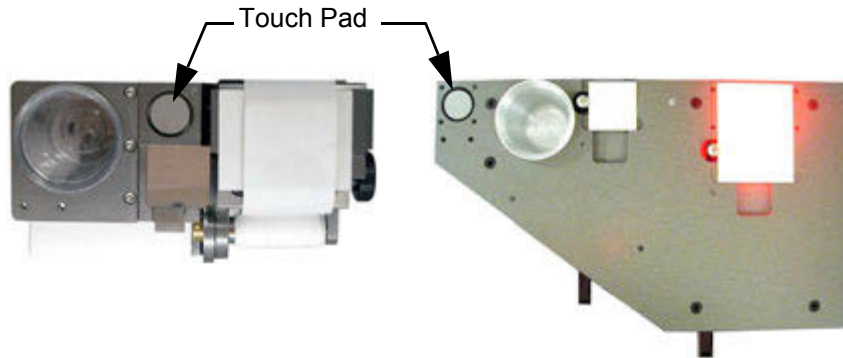

Surface Cleaning

- Clean the top surface of the touch pad with alcohol or acetone.
- Be careful to limit cleaning fluid to the touch pad surface only; cleaning fluid can damage the sensor located below the touch pad.
- The cleaning solvent you use depends on the material being cleaned.

Deep Cleaning

If necessary, the touch pad may be removed from the calibration station so it and the area in which it sits can be thoroughly cleaned.

1. Locate the height switch button.
2. Gently pull the touch pad out of the calibration station with a suction tool or needle nose pliers.
3. Thoroughly clean the touch pad with alcohol or acetone.
4. Clean the area in which the touch pad sits with a swab dampened with alcohol, being careful not to damage the sensor.
5. Carefully place the touch pad back in the calibration station.
6. Verify touch pad sensor function. Refer to TEST Touch Pad in Periodic Operations.

CLEAN Touch Probe



Daily

1. Raise Z axis to top of z travel so adequate room exists to remove full length of probe.
2. Remove the touch probe from the surface sensor assembly by grasping the knurled nut at the base of the touch probe and pulling straight downward until both the nut and touch probe pull away from and out of the mount.
3. Clean the touch probe with a soft, clean cloth and alcohol.
4. Reinstall the touch probe:
 - a. Locate the slotted nut base and the relief area on the touch probe (refer to frame A in the graphic at right).
 - b. Position the touch probe relief area in the nut base slot (refer to frame B).
 - c. While maintaining the position of the nut on the touch probe (refer to frame C), slide the touch probe into the surface sensor assembly, and snap the nut onto the mount.

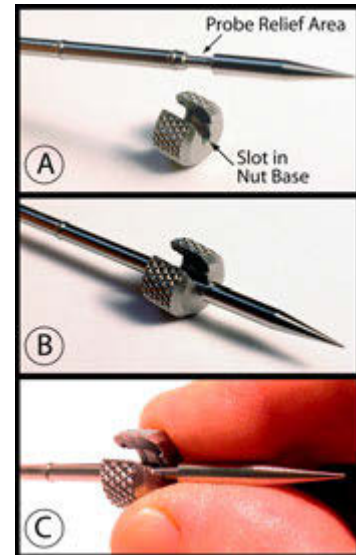

Demagnetizing Touch Probe

Depending on the material from which a touch probe is made, it may need to be demagnetized every 3 to 6 months:

1. Remove touch probe and touch probe bushing from surface sensor assembly:
 - Touch probe - (Item 6 on Dwgs 22293033 and 22100128)
 - Touch Probe Bushing - (Item 3 on Dwgs 22293033 and 22100128). To remove touch probe bushing, remove the two set screws located on the left side of the surface sensor assembly. Removal of the set screws should release the bushing from the mount.
2. Demagnetize both the touch probe and touch probe bushing using a demagnetizing tool. Be sure to demagnetize these parts separately.
3. Clean the probe and bushing with alcohol and a soft, clean cloth before reinstalling them in the surface sensor assembly.

Suggested Spare Parts

Table 19: Touch Probe Spare Parts

Description	Part No.	Qty
O-ring	10/3520	2
Touch Probe (MAX Series)	22203215	1
Touch Probe (DS Series)	22121310	1

Cleaning Pumps

- [Pump Cleaning Guide](#) (pg 5.71)
- [Cleaning Kits](#) (pg 5.71)
- [Quick Clean/Purge](#) (pg 5.71)
- [CLEAN Auger Pump](#) (pg 5.72)
- [CLEAN Needle Pump](#) (pg 5.72)
- [CLEAN Spool Pump](#) (pg 5.74)

Pump Cleaning Guide

Dispensing pumps should be cleaned any time the following conditions occur.

Table 20: Pump Cleaning Guide

Pump	Condition	Recommended Action
Auger, Needle, Spool	System is not run continuously.	You may clean a pump (auger and needle pumps only) while it is mounted on the dispenser. Refer to PURGE Pumps (Online) (pg 5.78).
	Switching materials.	
	Needle is clogged.	Replace needle or clean per pump-specific instructions or CLEAN Needle (pg 5.63).
	Pump is inactive over five (5) hours, especially when using solder paste or adhesives.	Clean per pump-specific instructions: For LX Auger pump, refer to CLEAN Auger Pump (pg 5.72). For Needle or Spool pump, refer to CLEAN Needle Pump (pg 5.72).
	Pump has been in use for a week.	
Micro-Dot	Refer to the <i>Micro-Dot Pump Guide</i> (p/n 22110265M).	
PCD	Refer to the <i>PCD Pump User Guide</i> (p/n 22293078M).	
Pinch Tube	Pinch tube has been in use for a week.	Replace the flexible tubing and needle.
	Material has exceeded its pot life.	

Cleaning Kits

Kits that include many of the cleaning and replacement parts you will need during the cleaning process are available from *Kits for Dispensers & Related Equipment* (PN 22290036).

When cleaning most pump types, GPD Global suggests using the Dispensing Start Up Kit. However, when cleaning a Micro-Dot pump, use the Tool Support Kit.

Quick Clean/Purge

When switching materials or when a quick pump cleaning is required, clean auger pumps and needle pumps online with purge compound. For details, refer to [PURGE Pumps \(Online\)](#) (pg 5.78).

CLEAN Auger Pump

Refer to the *LX Auger Pump User Guide* (p/n 22110085M) for all cleaning, priming, and disassembly instructions.

CLEAN Needle Pump

To remove and thoroughly clean the needle pump and remove all dispense material from its entire material flow path, remove and disassemble the pump, and then clean it per the following guidelines and instructions.

Guidelines

It is important that:

- the needle pump is run with clean, dry, lubricated air. This will keep the air piston in good working order.
- you lubricate the packing with a light oil by filling the chamber inside the packing nut. The oil will coat the pump needle and lubricate the packing. If material should begin to leak from the packing nut, it can be tightened to improve the seal.

Cleaning Needle Pump

To clean a needle pump:

1. Remove the needle pump from system:
 - a. Turn off syringe air pressure for the applicable pump mount position.
 - b. Remove the air adaptor from the pump assembly.

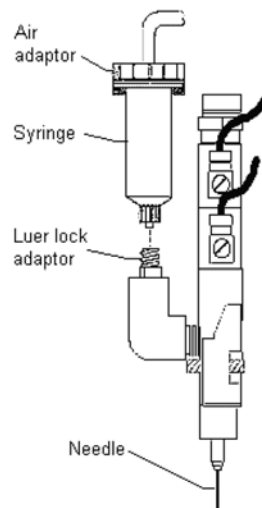

- c. Remove the syringe from the Luer-Lok adaptor.
- d. Disconnect the pump's air line from the power/air distribution panel.
- e. Remove and discard the needle tip.

~ continued ~

- f. Using a 3/32" Allen wrench, remove the pump assembly from the mounting bracket.
2. Disassemble the needle pump:
 - a. Using a 3/32" Allen wrench, unscrew the two socket head screws (one above each spacer). Remove the screws from the needle pump assembly.
 - b. While being careful not to bend the needle, pull the upper air body straight out of the fluid section.
3. To clean the pump body:
 - a. Unscrew and remove the adaptor section.
 - b. Clean the needle and fluid sections of the pump body with isopropyl alcohol.

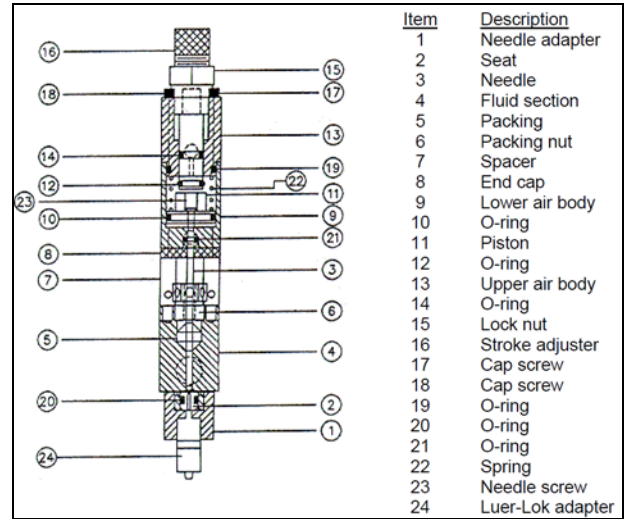

NOTE: DO NOT clean a needle with fibrous cloths, swabs, "pipe cleaners", or other objects which tend to leave filaments behind. Small filaments will clog the needle and render it useless.

NOTE: DO NOT use a high temperature bath. High temperatures may cure material in the needle.

- c. Using an air nozzle supplied with clean, dry shop air, blow excess material out of both the adaptor section and down through the needle shaft of the fluid section. d. Clean both the adaptor and fluid sections thoroughly with isopropyl alcohol.
4. Reassemble the needle pump:
 - a. Lubricate the needle with light oil.

NOTE: It is important that you lubricate the packing with a light oil by filling the chamber inside the packing nut. The oil will coat the pump needle and lubricate the packing. If material should begin to leak from the packing nut, it can be tightened to improve the seal.
 - b. Gently slide the needle (upper air body) into the fluid section's needle shaft.

NOTE: The fit between the needle and the shaft chamber is very precise and extreme care must be used to insert the needle straight and allow it to center itself in the chamber.
 - c. Screw the socket head screws into place.
 - d. Reattach the air adapter.
 - e. Return the needle pump to the appropriate mount position on the dispenser.

CLEAN Spool Pump

To remove and thoroughly clean the spool pump and remove all dispense material from its entire material flow path, remove and disassemble the pump, and then clean it per the following instructions.

Disassembly

To disassemble and clean spool pump:

Tools Required

- O-ring removal tool
- Retaining ring pliers with 0.053" tip

Procedure

1. Turn off the syringe air pressure for the applicable pump mount position.
2. Remove all hoses and fittings from the pump body (Item 6).

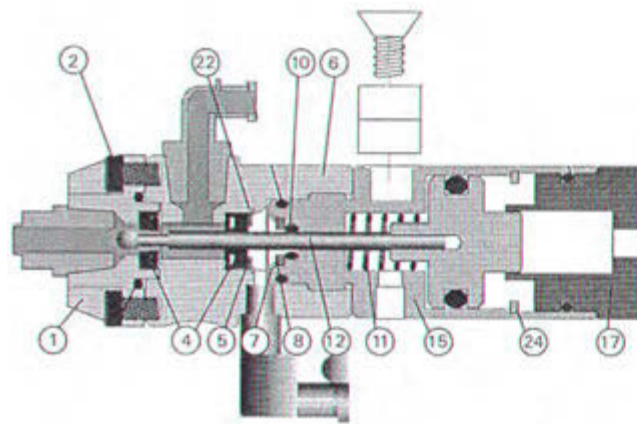

Item	Description
1	Outlet block
2	Socket cap screws
4	Seal
5	Stainless steel washer
6	Valve body
7	Retaining ring
8	Nylon washer
10	O-ring
11	Spring
12	Spool
15	Air cylinder
17	End cap
22	Retaining ring
24	Retaining ring

3. Unscrew the End Cap (17) and rotate the Air Cylinder (15) counterclockwise. When completely un-threaded, pull the two pump segments straight apart to separate.
4. Using retaining ring pliers, remove Retaining Ring (22). Remove Stainless Steel Washer (5) from pump body.
5. Note orientation of the Seal (4) in Pump Body (6) prior to removal. Remove Seal.
6. Remove four [4] Socket Cap Screws (2) in Outlet Block (1) and separate Outlet Block (1) from Pump Body (6).
7. Note orientation of Seal (4) in Outlet Block (1) and remove.
8. Clean and inspect Spool (12), Seal surface, and Seals (4) for wear and damage. Replace parts as necessary. If an air cylinder seal needs to be replaced, refer to [REMOVE / REPLACE Air Cylinder Seal](#) (pg 5.80) for details.
9. Reassemble pump per the [Reassembly](#) (pg 5.75) instructions.

Reassembly

1. With Seal (4) properly oriented, insert Seal into Pump Body (6) using a soft rod (such as a wooden dowel or pencil) to insure Seal is fully seated.
2. Insert Stainless Steel washer (5) and secure with Retaining Ring (22) using retaining ring pliers.
3. Thread the Air Cylinder (15) into the Pump Body (6) taking care not to cross thread or over tighten.
4. Insert Seal (4) into the outlet Block (1) and reassemble Outlet Block (1) to Pump Body (6).
5. Install Spring (11).
6. Insert Spool Assembly (12) into Air Cylinder (15) and secure with Retaining Ring (24).
7. Thread end cap (17) into Air Cylinder Assembly (15). Adjust to first mark in cap.
8. Return the pump to the appropriate mount position on the dispenser.

Lubrication Procedures

LUBRICATE Conveyor Belt Drive Chain

DS SERIES ONLY

The conveyor belt drive chain should be cleaned and lubricated annually or as needed.

To clean and lubricate the conveyor belt drive chain:

1. Locate the conveyor belt drive chain housing at the downstream end of the conveyor.
2. Remove the drive chain housing by removing its top screws.
3. Remove the drive chain:
 - a. Loosen, but do not remove, the adjustment lock screws.
 - b. Slide motor plate toward machine until enough slack exits to remove chain.
 - c. Slip the drive chain off of all sprockets.
4. Remove debris from the drive chain by cleaning it with a typical solvent or mild cleanser.
5. Reinstall the drive chain:
 - a. Thread the drive chain over the sprockets.
 - b. Slide the motor plate away from machine to lightly tension the chain.
 - c. Tighten the adjustment lock screws.

NOTE: Do not over tighten the drive chain. Chain tension should have a total deflection of 1/8" to 3/8" (3.2 to 9.5 mm).

6. Lubricate the drive chain lightly with molly grease.
7. Reinstall the drive chain housing and secure it with screws.

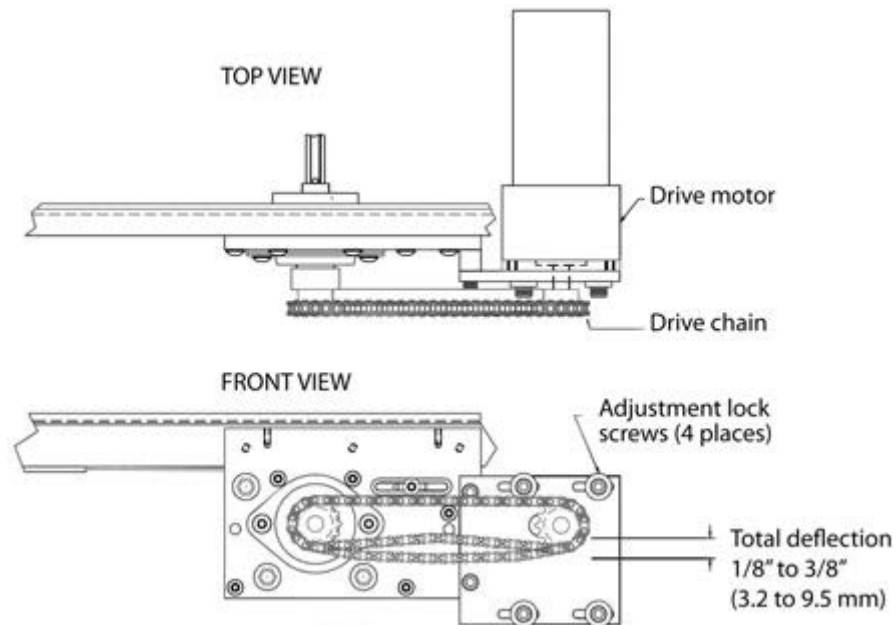

LUBRICATE Ball Screws & Linear Rails

Use the following procedure when lubricating ball screws and linear rails. The primary purpose of lubrication for linear motion rolling guides is to keep the raceways, rolling elements, and cages from direct metal-to-metal contact, thereby reducing wear and friction.

To lubricate ball screws and linear rails:

1. Clean all ball screws and linear rails with alcohol or equivalent.
2. Lubricate the X and Y **linear rail** via the grease fittings with NSK AS2 grease from the dispenser spare parts kit (MicroMax Kit p/n 22290005A or DS Series Kit p/n 22110015B).
3. Apply a light coating of a GPD Global-approved lubricant to the **ball screws**. All three axis (XYZ) ball screws use NSK AS2 grease from the dispenser spare parts kit.
4. Lubricate the Z-axis **linear rails** (see below) through the holes at the end of the bearing pad with a pipette (p/n 10/3303) of Mobil Vactra No. 2 or equivalent. The Z axis linear rails use a different type of bearing than the X and Y axis linear rails; thus, the different type of lubricant.

MAX SERIES ONLY - Z axis linear rails

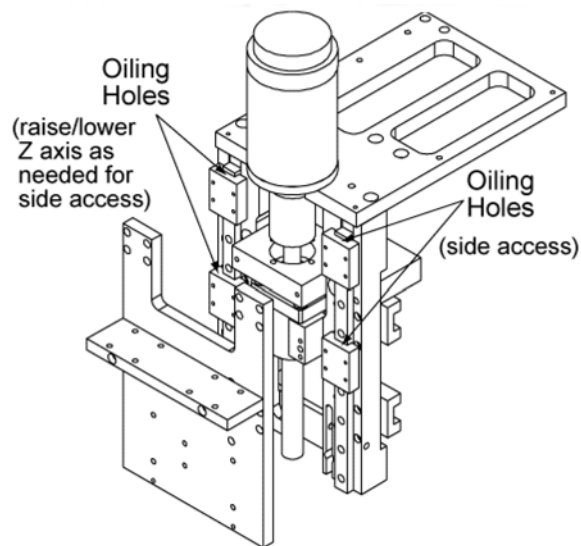

DS SERIES ONLY - Z axis linear rails

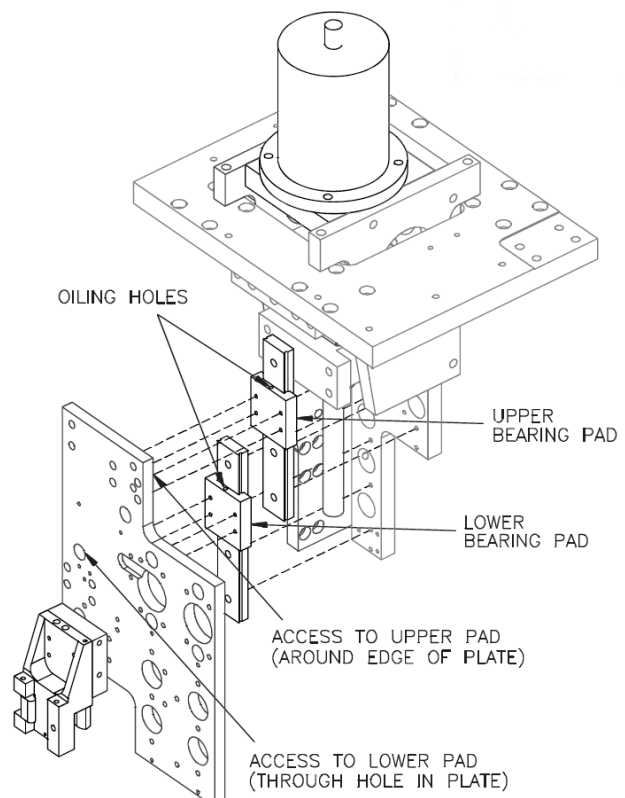

Purging Procedures

PURGE Accounting Data

If the Job Accounting/Management Info feature is turned on in the control software, the operator may be asked to make periodic reports from the collected data. Since the data continues to accumulate, it must be purged occasionally or else the system may become sluggish, particularly when powering on the machine. Although purging is normally the job of the system engineer or administrator, the operator may be authorized to perform this function.

To purge accounting data:

1. From the main menu bar, click Operations > Enter Password.
2. Enter a password providing access to accounting purge.
3. From the main menu bar, click Utilities > Management Info > Show Job Info.

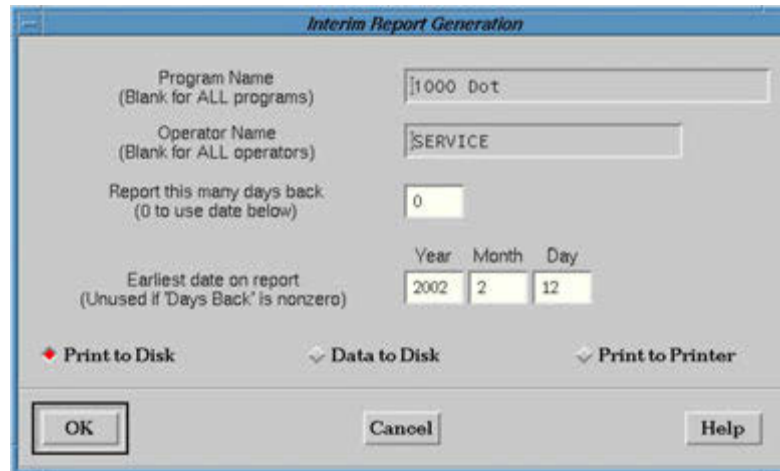

4. Enter or select the items needed to purge the obsolete data:
5. After all selections are made, click OK to purge the file, or click CANCEL to exit without purging.

PURGE Pumps (Online)

These instructions apply to auger pumps and needle pumps. When switching materials or when a quick pump cleaning is required, clean auger pumps and needle pumps online with purge compound.

GPD Global suggests using purge compound to clean out pumps, however, to clean an auger pump even more thoroughly, you may use a compatible solvent instead. For a list of solvents compatible with the auger pump o-ring, refer to *Solvent & O-Ring Compatibility* in the *LX Auger Pump User Guide* (p/n 22110085M).

To purge a pump online:

NOTE: If purging a PCD pump, refer to the priming instructions in the *PCD Pump User Guide*.

1. Load purge compound:
 - a. Turn off the syringe air pressure for the pump mount position to be cleaned.
 - b. Remove the material syringe by removing its air adaptor and unscrewing the syringe from the Luer-Lok adaptor. Cap the syringe with a syringe tip cap.
 - c. Place a syringe of purge compound on Luer-Lok adaptor.
 - d. For best results and a quicker purge process, remove and discard the pump needle.
 - e. Reattach air adaptor, turn on air pressure, and regulate pressure to approximately 8 psi (55 kPa).

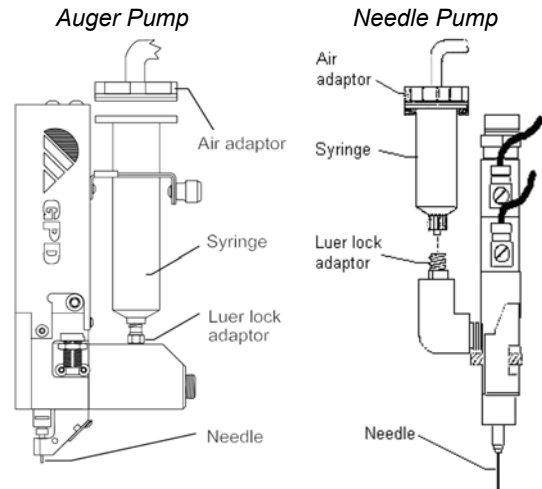

CAUTION Do not keep air pressure on the material barrel when not dispensing, especially when using solder paste. Extended exposure to air pressure can cause material separation.

ATTENTION

Ne pas maintenir la pression d'air dans l'injecteur cylindrique quand on n'emploie pas le distributeur, surtout quand on utilise de la soudure en pâte. Une exposition prolongée à la pression d'air peut provoquer la séparation des matériaux.

VORSICHT!

Luftdruck darf nur an die Materialtrommel angelegt werden, wenn Material ausgegeben wird. Dies gilt insbesondere beim Gebrauch von Lötpaste. Nach längerem Einwirken von Luftdruck kann es zur Materialabtrennung kommen.

ATTENZIONE

Non tenere la pressione pneumatica sulla siringa quando non si esegue erogazione, specialmente quando si usa la pasta da saldatura. Una prolungata esposizione alla pressione pneumatica può causare la separazione del materiale.

PRECAUCIÓN

No mantenga la presión neumática en el cilindro del material cuando este cilindro no esté suministrando el material, especialmente al usar pasta de soldadura. La exposición prolongada a la presión neumática puede ocasionar la separación del material.

2. Purge pump online:
 - a. Verify that a purge cup is present in the calibration station.
 - b. Click on Machine Controls > Offline Operations, select the desired head mount position, and set the pumps as needed. Purge time should be set to 0 to allow manual control.
 - c. To start the purge process, click PURGE. Continue purging until the pump discharges only purge compound (2-3 minutes). When purging with a purging compound, the pump should dispense consistent purging compound for a minimum of one (1) minute.
 - d. When the pump is clear of dispensing material, stop the purge process by clicking DONE on the Information prompt.
 - e. Fit the pump with a new needle.

Remove/Replace Procedures

- [REMOVE / REPLACE Air Cylinder Seal](#) (pg 5.80)
- [REMOVE / REPLACE Camera or Lens](#) (pg 5.82)
- [REMOVE / REPLACE Computer Removable Hard Drive](#) (pg 5.85)
- [REMOVE / REPLACE Conveyor Belt](#) (pg 5.86)
- [REMOVE / REPLACE Fuses](#) (pg 5.87)
- [REMOVE / REPLACE Liquid Dispense Pump](#) (pg 5.88)
- [REMOVE / REPLACE Safety Interlocks](#) (pg 5.89)

REMOVE / REPLACE Air Cylinder Seal

Replace the air cylinder seal in the Spool Pump on an as needed basis. To clean the spool pump during the air cylinder inspection and replacement process, continue with [Cleaning Pumps](#) (pg 5.71).

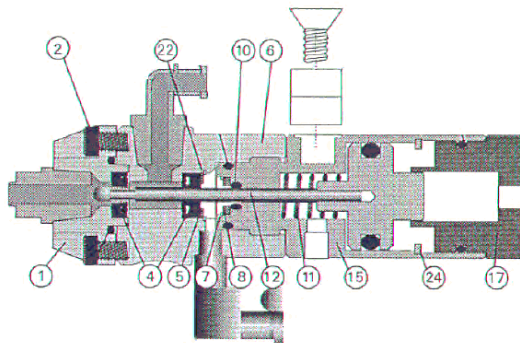

Item	Description
1	Outlet block
2	Socket cap screws
4	Seal
5	Stainless steel washer
6	Valve body
7	Retaining ring
8	Nylon washer
10	O-ring
11	Spring
12	Spool
15	Air cylinder
17	End cap
22	Retaining ring
24	Retaining ring

Tools Required

- Internal retaining ring pliers with 0.035" tip
- O-ring removal tool

Procedure

1. Disassemble the pump:
 - a. Turn off the syringe air pressure for the applicable pump mount position.
 - b. Remove all hoses and fittings from the pump body (Item 6).
 - c. Unscrew the End Cap (17) and rotate the Air Cylinder (15) counterclockwise. When completely un-threaded, pull the two pump segments straight apart to separate.
2. Remove the following parts:
 - a. Remove Retaining Ring (7) with retaining ring tool, then remove Nylon Washer (8) from Air Cylinder (15).
 - b. Remove O-ring (10) using O-ring tool.
3. Clean and visually inspect all parts for damage. Replace as necessary.
4. Lubricate O-ring (10) using approved lubricant (such as "Parker O-Lube" or equivalent) and insert O- ring (10) into Air Cylinder (15).
5. Insert Nylon Washer (8) and, using retaining ring pliers, secure Retaining Ring (7).

6. Reassemble pump using the Reassembly instructions:
 - a. With Seal (4) properly oriented, insert Seal into Pump Body (6) using a soft rod (such as a wooden dowel or a pencil) to insure Seal is fully seated.
 - b. Insert Stainless Steel washer (5) and secure with Retaining Ring (22) using retaining ring pliers.
 - c. Thread the Air Cylinder (15) into the Pump Body (6) taking care not to cross thread or over tighten.
 - d. Insert Seal (4) into the outlet Block (1) and reassemble Outlet Block (1) to Pump Body (6).
 - e. Install Spring (11).
 - f. Insert Spool Assembly (12) into Air Cylinder (15) and secure with Retaining Ring (24).
 - g. Thread end cap (17) into Air Cylinder Assembly (15). Adjust to first mark in cap.
7. Return the pump to the appropriate mount position on the dispenser.

REMOVE / REPLACE Camera or Lens

These instructions, **applicable only to the optional ClearVu Vision option**, explain how to replace the camera and lens on the following dispenser models.

Table 21: Camera & Lens Part Numbers by Machine Model

Dispenser Model	ClearVu Vision	Camera
MAX Series	22293004	10/1565
DS Series with open-faced gantry	22100096	10/1565

The ClearVu Vision assembly consists of a camera, a lens, and an adapter between the camera and lens. The lens and camera/lens adapter shown below are specific to the ClearVu Vision option.

Figure 30: Major components of Camera/Lens for ClearVu Vision

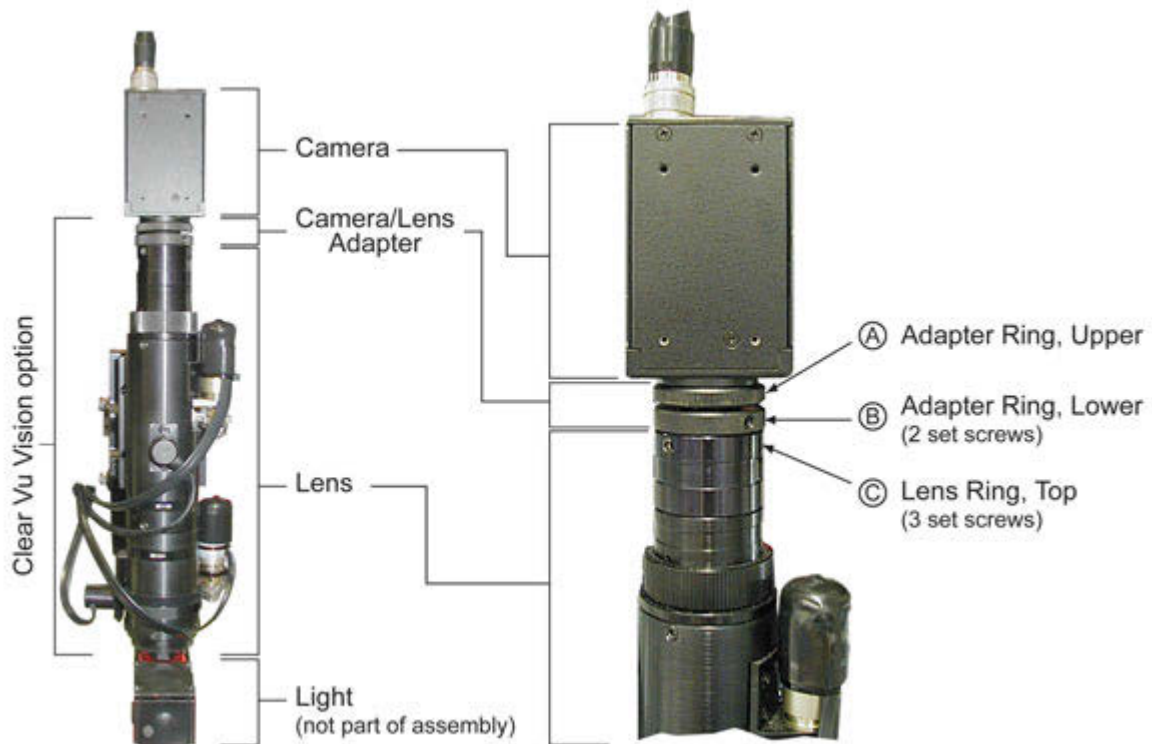

Replacing Camera or Lens

Camera or lens replacement requires resetting the focus height and aligning the camera with the dispenser and the lens.



IMPORTANT Replace the ClearVu Vision camera or lens **ONLY** on an as needed basis. Realigning the vision system is an involved process and any change to the camera or lens may require changing all models/patterns used by your programs.

The camera/lens and lens mount assemblies can be removed and then reinstalled on the dispenser as a single assembly.



IMPORTANT For the following procedure, the assumption is made that the camera/lens and lens mount assemblies have been removed from the **camera mount plate**.

Typically, you **DO NOT** want to remove the entire camera/lens and lens mount assemblies from the **camera mount plate** (refer to Figure 31). Removing the entire camera/lens assembly from the **camera mount plate** rather than from the **lens mount** requires the additional procedure of reestablishing perpendicularity to the dispenser.

Tools Required

- 3/16" wrench
- 3/32" wrench
- 5/64" wrenches (2)

Procedure

Either the camera and/or the lens can be replaced. To replace one or the other or both:

1. Remove Camera

To replace the camera, select the instructions from the table below that pertain to your situation; otherwise, continue with [Step 2](#). Clearance available for camera removal varies between dispenser types.

Table 22: Camera Removal based on Available Clearance

IF	THEN
...there is adequate clearance to remove only the camera	...carefully unscrew the camera from the Focusing Ring (refer to Figure 30, Item A). DO NOT loosen any set screws.
...there is NOT enough clearance to remove ONLY the camera	<p>A - Carefully remove the camera/lens assembly from the camera mount plate by unscrewing the four (4) lens mount screws (refer to Figure 31).</p> <p>B - Remove the camera from the camera/lens assembly by carefully unscrewing the camera from the Focusing Ring (Item A in Figure 30). DO NOT loosen any set screws.</p> <p>C - Mount the camera/lens assembly on the camera mount plate and snug the four (4) lens mount screws.</p>

2. Replace Lens

To replace the lens, follow the instructions below, otherwise, continue with [Step 3](#).

- a. Remove the camera/adaptor assembly from the lens by removing the four (4) lens mount screws (refer to Figure 31) and loosening the three (3) Lens Ring set screws (refer to Figure 30, Item C).
- b. Install the camera/adaptor assembly in a new lens and equally snug the three (3) Lens Ring set screws (Figure 30, Item C).

Figure 31: Screw locations for mounting Camera/Lens



- c. Install the camera/adaptor assembly in a new lens and equally snug the three (3) Lens Ring set screws (Figure 30, Item C).
- d. Install the camera/lens assembly on the camera mount plate.

- e. As needed, adjust camera position relative to the dispenser:

Table 23: Lens Removal based on Current Position

IF	THEN
...the camera/lens assembly is in the same plane as the front of the dispenser	...continue with Step 3.
...the camera/lens assembly is NOT in the same plane as the front of the dispenser	...using 5/64" wrenches, equally loosen the two (2) set screws in the Focusing Lock Ring (Figure 30, Item B) just enough to allow the camera/lens assembly to rotate. Rotate the camera into desired position and then equally tighten the two (2) set screws (Figure 30, Item B).

3. Mount Camera/Lens Assembly on Dispenser

Position the camera/lens assembly and lens mount assembly on the dispense system and secure it in place using a 3/16" wrench to lightly tighten the two (2) camera mount plate screws (refer to Figure 31 for screw locations).

4. Align and Focus Camera/Lens

Make the necessary adjustments for proper alignment and focus of the Camera/Lens assembly. For details, refer to [ADJUST Camera/Lens Alignment](#) (pg 5.5).

5. Map the Work Area

The correlations that result from mapping the work area are used by the gantry for more precise movement for control and application. Using the Precision Contour Mapping Calibration Kit appropriate for your model of dispenser (refer to Table 24), calibrate the work area by performing the mapping procedure detailed in the Precision Contour Mapping Calibration instructions that accompany the kit.

Table 24: Kit Selection Guide

Model	Precision Contour Mapping Calibration Kit
MAX Series	P/N 222DMAXMAP
DS Series:	
DS 9000	P/N 221DS90 MAP
DS 9100	P/N 221DS91 MAP

6. Inspect for Impact on Existing Patterns

Run several programs on sample product and inspect the results to find if the camera or lens replacement has affected your existing program patterns. Make necessary program changes.

REMOVE / REPLACE Computer Removable Hard Drive

For details on how to turn a removable hard drive on and off, and how to remove it while the computer is running, refer to [Removable Computer Hard Drive](#) (pg 8.3)

REMOVE / REPLACE Conveyor Belt

The conveyor moves product through the dispensing machine on a pair of edge belts. For belt part number, refer to *Kits for Dispensers & Related Equipment* (PN22290036) for the appropriate conveyor model.

 **IMPORTANT** Always replace BOTH conveyor edge belts when replacement is needed.

To replace conveyor belts:

1. [Power Off](#) (pg 3.4) the dispenser.
2. Using an appropriate tool, release belt tension by loosening the hex bolt on the take-up pulley.

MAX Series

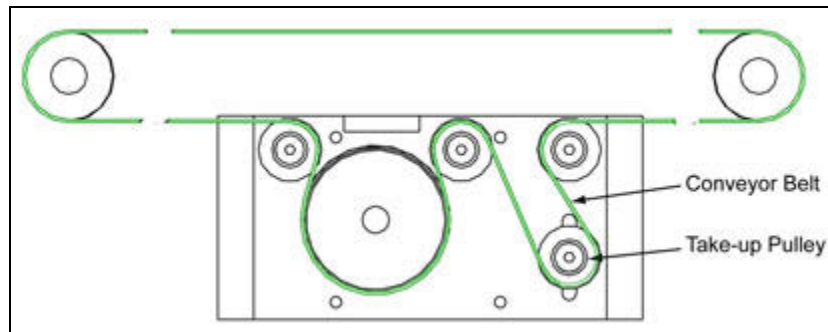

DS Series

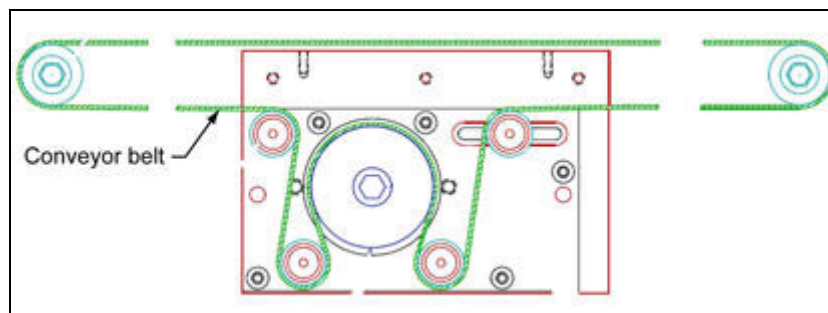

3. Slip the belt off of all pulleys.
4. Install a new belt by threading it over all pulleys and around the drive wheel.
5. Adjust belt tension as necessary. Refer to [ADJUST Conveyor Belt Tension](#) (pg 5.23).
6. To replace other belt, repeat procedure.

REMOVE / REPLACE Fuses

This section provides information on where to find and identify system fuses and how to replace them.

To replace a fuse:

1. [Power Off](#) (pg 3.4) the machine per normal procedures.
2. Locate the faulty fuses using the tables that follow - select the table applicable to your dispenser model.
3. As necessary, replace the fuse.

MAX Series Fuse Guide

Table 25: Guide to Identifying & Locating Fuses on MAX Series

Fuse Location* on Base Plate	Fuse I.D.	Items Affected	Fuse Description **
Power Control	CA 1 CA 2 CA H1	Main system power.	10A Circuit Breaker 5A Circuit breaker 25A (high power heated units)
AC Box	FD 1U FD 1D	Upstream SMEMA I/O signals. Downstream SMEMA I/O signals.	1A, 250V (ABC12) 1A, 250V (ABC12)
I/O Module Board†	F1 F2	12 V system supply voltage. 24 V system supply voltage.	2A, 250 V, sub-miniature 6A, 250 V, sub-miniature

* Electrical schematics are located in your system's serial number-specific Electrical Schematics document.

** Unless otherwise specified, fuses are 1/4 x 1-1/4".

† Each board has two fuses: one for 12VDC and one for 24VDSC.

DS Series Fuse Guide

Table 26: Guide to Identifying & Locating Fuses on DS Series

Fuse Location*	Fuse I.D.	Items Affected	Fuse Description **
Base Plate	CA 1 CA 2 CA H1	Main system power	10A Circuit Breaker 5A Circuit breaker 25A (high power heated units)
Electronics Drawer			
Service Panel	FD 1U FD 1D	Upstream SMEMA I/O signals. Downstream SMEMA I/O signals.	1A, 250V (ABC12) 1A, 250V (ABC12)
I/O Module Board†	F1 F2	12 V system supply voltage. 24 V system supply voltage.	2A, 250 V, sub-miniature 6A, 250 V, sub-miniature
Servo Board†	F1 F2	12 V system supply voltage. 24 V system supply voltage.	2A, 250 V, sub-miniature 6A, 250 V, sub-miniature

* Electrical schematics are located in your system's serial number-specific Electrical Schematics document.

** Unless otherwise specified, fuses are 1/4 x 1-1/4".

† Each board has two fuses: one for 12VDC and one for 24VDSC.

REMOVE / REPLACE Liquid Dispense Pump

To remove a liquid dispense pump from a mount position:

1. Disconnect the pump air line from the power/air distribution panel.
2. Remove and discard the pump needle.
3. Cap the syringe with a syringe tip cap.
4. Remove the air adaptor.
5. Loosen the clamp bolt and remove the material syringe from the syringe holder.
6. As needed, refrigerate the material syringe.

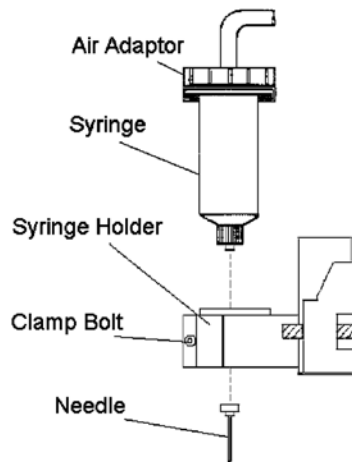

REMOVE / REPLACE Safety Interlocks

Each safety shield (and safety shield door) is equipped with a window safety interlock. Test safety interlock function using [TEST Safety Interlocks](#) (pg 5.112) and then, as needed, replace any safety interlock that does not function properly.

Safety Shields

To replace a faulty safety interlock for a safety shield:

1. Turn off machine power per the [Power Off](#) (pg 3.4) instructions.
2. Unplug machine power.
3. Remove the cover from the faulty safety switch.
4. Disconnect the exposed wire inside the safety switch.
5. Remove the safety switch strain relief, mounting bolts, and shield ground.
6. Install a new switch (p/n 10/0417) by following the above steps in reverse order.

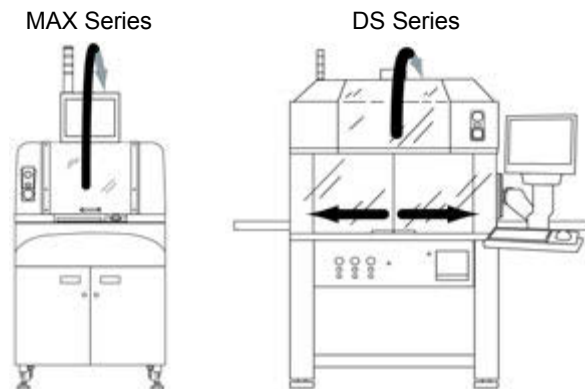

Safety Shield Doors

DS SERIES ONLY

To replace a faulty safety interlock for a safety shield door:

1. Turn off machine power per the [Power Off](#) (pg 3.4) instructions.
2. Unplug machine power.
3. Remove the cover from the faulty safety switch.
4. Trace the safety switch wiring to TS2 and disconnect the wires.
5. Remove the safety switch mounting bolts and the faulty safety switch.
6. Install a new switch (p/n 10/1825) by following the preceding steps in reverse order.

Setup Procedures

- [SET UP Alarms](#) (pg 5.90)
- [SET UP Conveyor](#) (pg 5.92)
- [SET UP Hard Drive Setup](#) (pg 5.94)
- [SET UP Needle Cleaner](#) (pg 5.95)
- [SET UP Scale](#) (pg 5.97)
- [SET UP Temperature Controller](#) (pg 5.107)
- [SET UP User Controls Access](#) (pg 5.110)

SET UP Alarms

The dispenser has been set up at the factory to associate certain alarm conditions with an audible alarm (either at the machine or at a remote location) and/or a visual alarm that illuminates or flashes a particular color on the status light tower. You can turn the audible system alarm on/off with the control software. To make changes to the alarm set up, call GPD Global for details.

Additionally, the optional, removable hard drive will sound an alarm to indicate fan failure.

Audible System Alarm

The audible alarm sounds when an alarm condition occurs. This alarm is controlled with an on/off toggle control box located in the main control panel window. For details about alarm conditions, refer to *Safety Systems - Audible Alarm* in the *Dispense System User Guide*.

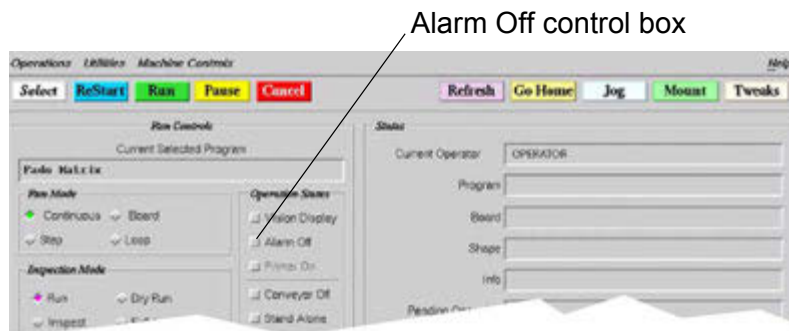

To silence a beeping alarm:

1. Click on Alarm Off to turn it off (control box will turn grey).
2. Click it once more (control box will turn red) to reactivate the alarm in case an additional alarm condition occurs.

Alarm On

The control box appears grey and raised. When an alarm condition occurs, the alarm continues beeping until the user either clicks OK on the screen prompt or turns the alarm off.

Alarm Off

The control box appears red and recessed. The alarm will not beep when an alarm condition occurs. There are no messages that override the Alarm Off condition.

Remote Audible System Alarm

The dispenser is capable of generating a signal to be used remotely to indicate out-of-range weight on the optional precision scale. This signal is intended to ring a bell in a location up to perhaps 1,000 feet from the machine. This alarm is not cleared remotely; it must be cleared at the dispenser.

To clear a remote alarm condition, continue with the main control panel window and click on Machine Controls > Clear Signal.

Fan Failure Alarm

A fan failure alarm is sometimes a feature on the optional, removable hard drive. If the cooling fan for the removable hard drive should fail, an alarm buzzer beeps and the red dot on the lower right corner of the display window for the removable hard drive will flash indicating the fan failure. Replace the fan.

Visual System Alarm

The status light tower illuminates or flashes colored lights to indicate machine status conditions. The following chart describes a typical set up for light colors and the types of conditions with which they are associated.

The light colors typically used for a dispenser status light tower are red, amber, and green. Each color is associated with information and/or error messages used by the control software. Only one light at a time will illuminate.

Table 27: Alarm Conditions by Tower Color

Color	Condition
Red	Mandatory condition. Requires action by the operator. Example: Safety violation or inadequate air pressure.
Amber	Operator intervention condition. Requires action by the operator when the machine becomes idle due to an occurrence that requires operator action for normal operations to continue. Example: Machine waits for operator to clean a needle or adjust the conveyor.
Green	Normal operating condition. Machine operations are in process or ready to run (even if waiting for an upstream or downstream machine, as long as there is not time out).

For a description of how status tower lights can be used, refer to *Safety Systems - Status Light Tower* in the *Dispense System User Guide*. To make changes to the status light set up, call GPD Global for details.

SET UP Conveyor

The conveyor must be set up initially to accommodate product width and thickness. Each time product of a different width and/or thickness is to be processed, perform the following procedure.

1. Adjust the distance between the conveyor rails for product width. For details, refer to [ADJUST Conveyor Width](#) (pg 5.30).
2. Adjust the conveyor to provide suitable product support, stability, and clearance at the required height. For details, refer to [ADJUST Conveyor Support & Height](#) (pg 5.26).
3. Adjust and calibrate conveyor belt speed(s). For details, refer to the [ADJUST Conveyor Speeds](#) (pg 5.25).
4. Supply the program with a board length value:

NOTE: If a board length value is not provided or is inaccurate, the conveyor stop pins will either spear the product or not close in time to stop the product:

- a. In the Program Editor, select the applicable program name, and enter a value in the Length field.

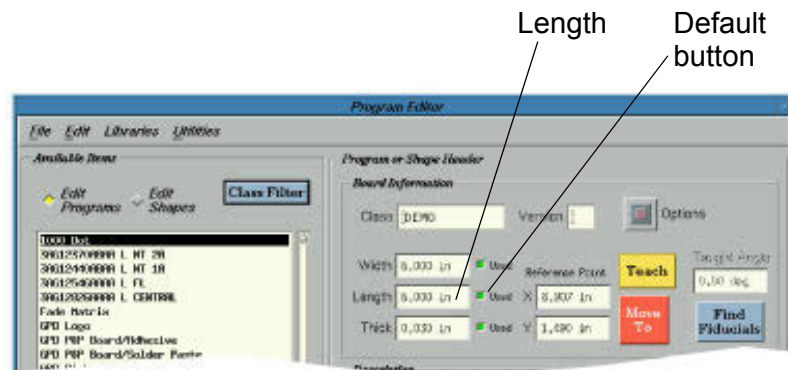

- b. Activate the new value by clicking the default button next to the Length field.
- c. Click APPLY EDITS.

5. Conclude conveyor setup:
 - a. Remove product from the conveyor.



WARNING Use extreme caution when safety shield doors are open. As necessary, open and close the safety shield doors and clear the safety violation condition throughout this procedure.

**ADVERTISSE-
MENT**

Exercez la plus extrême prudence quand les portes de l'écran de protection sont ouvertes. S'il le faut, ouvrez et fermez les portes de l'écran de protection et désamorcez le signal de violation de la sécurité tout au long de cette procédure.

ACHTUNG

Bei offenstehenden Schutzabdeckungsstüren müssen Sie mit äußerster Vorsicht vorgehen. Bei Bedarf können Sie die Schutzabdeckungsstüren öffnen und schließen und dabei den Sicherheitsverstoßzustand beheben.

AVVERTENZA

Bei offenstehenden Schutzabdeckungsstüren müssen Sie mit äußerster Vorsicht vorgehen. Bei Bedarf können Sie die Schutzabdeckungsstüren öffnen und schließen und dabei den Sicherheitsverstoßzustand beheben.

ADVERTENCIA

Actúe con extrema cautela cuando las puertas de protección de seguridad estén abiertas. Según sea necesario, abra y cierre las puertas de protección de seguridad y desactive la señal de violación de seguridad durante todo este procedimiento.

- b. Close the safety shield(s) and clear the safety violation prompt.

SET UP Hard Drive Setup

Follow these instructions when setting up a new hard drive in the dispenser.

REQUIRED: You must use a copy of the GPD *CMOS Set Up* document during the setup procedure. This document is motherboard model specific. To request the correct version from GPD, please specify both the model of motherboard in your computer and document part number 22100114.

To set up a new hard drive:

1. Is the hard drive to be set up a PATA type?
 - No. Skip to step [Step 2](#).
 - Yes. *PATA type computers built prior to May 2018 require the following configuration.*

Configure the hard drive by verifying that the hardware jumper positions are correct for the scenario applicable to your dispenser:

Table 28: Jumper Setting for Hard Drive Scenario

Hard Drive Scenario	Jumper Setting
Single	single
Secondary fixed	slave (the primary hard drive should be set for “master”)

NOTE: If your system does not recognize the drive, it may require the CAP limit jumper be installed. Some older computers may not recognize larger capacity drives.

2. As needed, set up the CMOS parameters while referring to the *CMOS Set Up* document. If a hardware failure has occurred, perform each of the procedures detailed in *CMOS Set Up* that applies to the situation.

SET UP Needle Cleaner

The optional, software-controlled Grip Type Needle Cleaner can be used to clean up to three heads, one at a time. This process can be utilized within a program and/or offline. Before needle cleaning operations can be used, some set up may be required.

Setting Up Needle Cleaner

Most of the set up required for the needle cleaner has probably already been done for you at the factory, however, most setup parameters may be modified, as needed, for process purposes. The cleaner must be configured for cleaner type and various operational parameters. Then the coordinates for each point in the cleaning path must be taught. Finally, permission to use the needle cleaner either within a program and/or offline must be set up.

The basic steps involved in setting up a needle cleaner are as follows:

1. **Establish Configuration.** The needle cleaner configuration is typically set up at the factory, however, you may modify various parameters such as needle velocity during cleaning, the incremental distance moved between successive cleaning dispenses, and the number of increments made before operator intervention is required. To modify configuration parameters, refer to *Needle Cleaner Setup* in the *FLOware Software Guide*.
2. **Teach Coordinates.** The cleaning path locations through which each head moves during the needle cleaning process are typically taught at the factory, however, you may reteach these cleaning path locations. To modify the coordinates at which needle cleaning operations begin and end, the type of pump motion used, and the velocity that occurs, refer to *Needle Cleaner Setup* in the *FLOware Software Guide*.
3. **Enable Feature.** When a dispenser is configured with optional needle cleaner(s), the user has the option of activating and deactivating the needle cleaner feature by turning the Auto Clean field on and off. The needle cleaner feature can be activated /deactivated for the material level, the program level, or for both of these levels.

Activating Needle Cleaner

Activating the needle cleaner enables it to automatically perform needle cleaning as part of a program run, or it can easily be used to perform needle cleaning offline after a purge, dispense, or run.

For details on how to control activation of the needle cleaner, refer to [CLEAN Needle Online with Needle Cleaner](#) (pg 5.66)

Deactivating Needle Cleaner

When the needle cleaner is deactivated, the system reverts to using the standard needle cleaning process of requiring the operator to take action (clean the needle and answer a prompt) before continuing with normal operations.

For details on how to control deactivation of the needle cleaner, refer to [CLEAN Needle Online with Needle Cleaner](#) (pg 5.66).

Using a Needle Cleaner

After the needle cleaner is set up, it can be used offline or during a program run.

Online Needle Cleaning

You may include the use of one or multiple needle cleaners within a program by activating the needle cleaner within a material or a program by turning the Auto Clean setting on. The Auto Clean setting within a program overrides the Auto Clean setting within the material used by that program.

To learn how to use a needle cleaner, refer to [CLEAN Needle Online with Needle Cleaner](#) (pg 5.66).

Offline Needle Cleaning

You can use the dispenser to clean a needle at the needle cleaner whenever the dispenser is offline (not running a process) by simply selecting the head to be cleaned and then clicking on two commands.

Once the needle cleaning cycle is complete, you may select a different head and repeat the needle cleaning process.

For further details, refer to [CLEAN Needle Offline with Needle Cleaner](#) (pg 5.65).

SET UP Scale

The optional, precision scale ensures the volume of dispensed material is continuously correct. Being a closed-loop system, automatic adjustments are made to appropriate dispensing parameters to ensure process control.

WMC24-SH Scale - Set Up

To set up a model WMC24-SH scale:

1. For an initial set up, level the scale per [ADJUST Scale to Level](#) (pg 5.34).
2. Remove the lid from the white Draft Shield and set it aside.



3. Remove the white, protective plastic Cover (B) from the scale. This cover protects the Weighing Pan Support (A) from damage; therefore, keep the cover in a safe place.

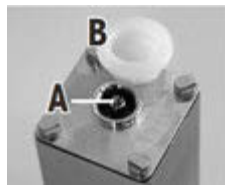

Protective Cover (B) removed, exposing Pan Support (A).

4. Install the silver Draft Shield (E) on the scale by evenly pressing down on two opposite corners of the Draft Shield until it engages with an audible 'click'.



5. Install the Purge Cup Support:
 - a. Before placing anything on the scale, power off the scale by powering off the dispenser.
 - b. Carefully place the Purge Cup Support (F) on the Weighing Pan Support (A).

 **CAUTION** DO NOT twist the Purge Cup Support into position as this may exert torque on the Weighing Pan Support which can damage the scale.

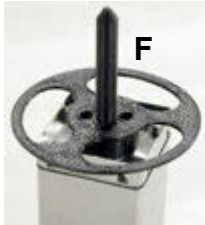

- c. Power on the dispenser.
6. Place a Purge Cup (G) on the Purge Cup Support (F).

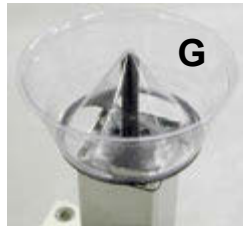

7. Before proceeding, allow the scale to warm up.

IMPORTANT: Allow the scale to warm up for 15 to 45 minutes before performing any weighing functions.

8. Verify the weight of a weigh unit and, as needed, adjust/calibrate the weigh unit value used by the scale. For details, refer to the Scale Weight Kit (PN 22213007) and included procedure.

 **CAUTION** Do not exceed the weight scale limit values: vertical load (1 kg static load maximum), lateral load (200 g static load maximum), or torsion (0.3 Nm maximum).

 **CAUTION** Always use a gloved hand or tweezers to handle the weigh unit.









9. Prior to operating the precision scale successfully via a dispenser program, certain parameters for the scale need to be set up in the control software. For details, refer to the *Scale Set Up Within Software* in the *FLOWare Software Guide*.

Scale set up is complete.

CP Scale - Set Up













To set up a CP precision scale (models **CP153** and **CP124S**):

1. For an initial set up, level the scale per [ADJUST Scale to Level](#) (pg 5.34).
2. Calibrate the scale prior to use. This will help ensure accurate results. Refer to [CALIBRATE Scale](#) (pg 5.55).
3. **Basic Weighing.** Perform the following these steps to conduct a basic weighing process.

Example Simple Weighing		
Setting in Balance/Scale Operating Menu: Line format for printout: For other applications/GLP (7 2 2)		
Step	Key (or instruction)	Display/Printout
1. Turn on the balance/scale Self-test is performed, followed by automatic initial tare function.		+ 0.0 g
2. Place container on balance/scale (in this example: 11.5 g).	 	+ 11.5 g
3. Tare the balance/scale.		+ 0.0 g
4. Place sample in container on balance/scale (in this example: 132 g).	 	+ 132.0 g
6. Print weight.	 / 	N + 132.0 g

4. **Set Up within Software.** Prior to operating the precision scale successfully via a dispenser program, certain parameters for the scale need to be set up in the control software. For details, refer to the *Scale Set Up Within Software* in the *FLOware Software Guide*.

5. **Configure Scale.** Note the following information regarding scale configuration.

<p>Purpose You can configure your balance/scale to meet individual requirements by selecting from parameter settings in a software menu.</p> <p>Key functions during configuration: Activate the settings menu: Press  to turn the balance/scale off and back on again. While all display segments are lit, press  briefly</p> <p>Scroll upward ↑: press </p> <p>Scroll right →: press  / </p> <p>Confirm input: press </p> <p>Store settings and exit menu: Press and hold  (2 sec.)</p>	<p>● Print Current Settings</p> <ul style="list-style-type: none"> - At the 3rd menu level (lowest level): Press and hold  /  > Printout: (Example) Menu 7 1 1 - At the 2nd menu level: Press and hold  /  > Printout (Example) Menu 7 1 1 Menu 7 2 1 Menu 7 3 1 - All current menu settings are printed when the 1st menu level (highest level) is displayed: Press and hold  /  > All current settings are printed.
--	---

~ continued ~

6. **Set Parameters.** Set up parameter settings in the scale itself. A chart of suggested, initial setting values follows.

Setting the Parameters (Menu Codes)

Example: Adapting the balance/scale to “very unstable” ambient conditions (menu code 1 1 4).

Step	Key (or instruction)	Display/Printout
1. Turn off the balance/scale.		
2. Turn on the balance/scale and while all segments are displayed:		
○ Scroll upward within a menu level; after the last menu code, the first code is displayed again.	briefly repeatedly	1 2 3 4
3. Select the second level (scroll to the right).	/	1 1
4. Select the third level (scroll to the right).	/	1 1 2 °
5. 3 rd menu level: Scroll until the desired number is shown.	repeatedly	1 1 4
6. Confirm change; “o” on display indicates active setting		1 1 4 °
○ Return to higher menu level (from the 3 rd level).	/	1
○ Set other codes as desired.	/ ,	
7. Store settings and exit the menu or	Press and hold (2 sec.)	
○ Exit menu without storing changes.		
> Restart application.		0.0 g

~ continued ~

Suggested Initial Settings

Use the suggested settings in the table below as a starting point for configuring your scale and then customize the settings as needed for your particular situation.

Table 29: Initial Settings Suggested for Scale Configuration

Parameter	Menu Level 3	Parameter	Menu Level 3
Weighing	113	Data interface	514
	121		523
	134		531
	152		542
	161	Print for weighing	612
	172		622
Application programs	181	631	
	191	641	
	1101	Printing with application programs	712
	1111		721
	211		731
Application parameters	3113	Extra functions	811
	321		821
	352		831
	362		841
	372		854
	382		881
			8101
Application parameters - Counting	411	Reset menu	9-2

~ continued ~

7. **Automatic Power On.** If desired, use the following procedure to cause the scale to switch on automatically under these conditions:
- after a power outage,
 - after it has been unplugged and then plugged back in, or
 - after the “I/O” button is pressed. When this setting is configured, the scale can not be turned off by pressing the “I/O” button.
- a. If your scale is of the “BL” series, continue with step 7.b. For all other models, continue with [Step 9 \(pg 5-104\)](#).
- b. Install the flat cable and set the scale to automatic power on per the following instructions:

(1) Lay the scale on its side. DO NOT turn the scale over (on the weighing pan) as this could damage the weighing system.

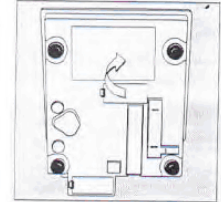

(2) Remove the plate from the bottom of the scale.

(3) Plug the flat cable into the scale PCB.

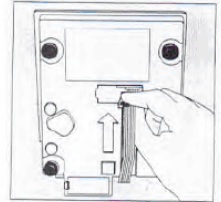

(4) Remove the cable holder.

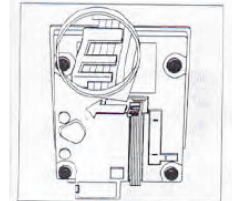

(5) Remove the protective plastic from the double-sided adhesive tape. Affix the flat cable to the scale housing. Replace the plate on the bottom of the housing.

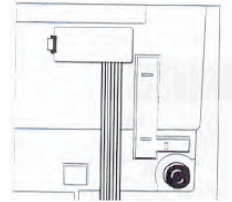

(6) Use the 2 screws supplied to fasten the interface part in the position made available by removing the plate (flat surface facing outward).

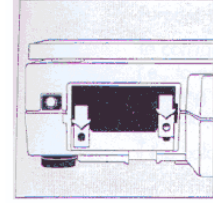

(7) Plug the flat cable into the PCB of the interface.

(8) Use the enclosed two screws and washers to fasten the interface to the scale.

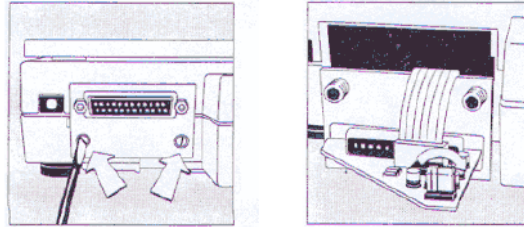
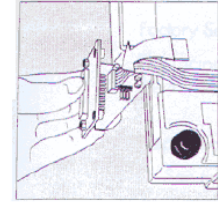

8. Change the position of the jumper on the interface. Place the scale on its side and verify that the switch is in the proper position by removing the small plate from the bottom of the scale housing and setting the revealed switch to the left position, toward the ribbon cable - refer to figure at right.

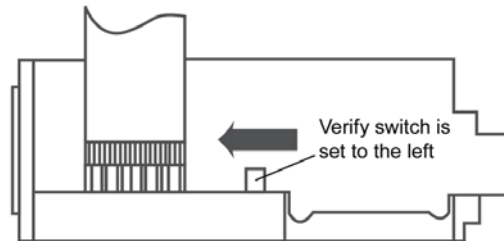

9. With dispenser power off, plug the scale power cord and the interface cable into the scale. The cables should be located in the work area. The communication cable should be plugged into the DigiBoard octopus cable labeled "P2" (refer to [Serial Communications Board](#) (pg 8.4)).
10. Allow the scale to warm up for 30 minutes after connecting to AC power or after a power outage to enable it to reach its required operating temperature.
11. **"BP" SERIES SCALES ONLY.** Set the power mode on the scale to Automatic power-on. When in this mode, the I/O (On/Off) button on the front of the scale will not turn the scale off. The scale will turn on and off with the power supply. The factory default setting is idle mode.

12. Program the Automatic power-on with a program code 854 per the following instructions:

Accessing the Menu (Example: Code 8 5 4)

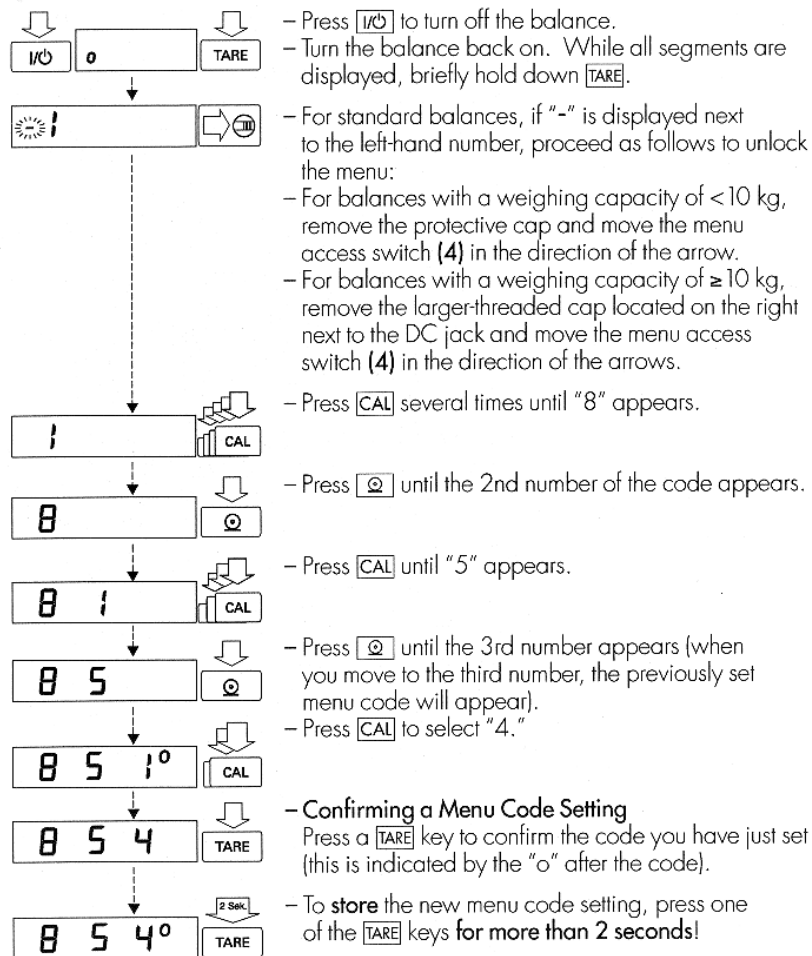

~ continued ~

The current code setting in the balance operating menu is identified by a small, superscript "o" after the last number. When you access the operating menu, the previously set code will be displayed after you have selected the right-hand number, which means the entire menu code setting will be displayed. This makes it easy for you to check the previously set menu codes.

If you would like to change several menu code settings, you do not have to press a [TARE] key after each change to exit the balance operating menu. You can also confirm individual settings.

Important Note Concerning Standard Balances: Please do not forget to relock the balance operating menu to avoid inadvertent changes to the settings. The symbol "—" indicates that the menu is locked.



Important Note Concerning Verified Balances Approved for Use as Legal Measuring Instruments in the EU*:

The balance operating menu on verified balances cannot be locked with the menu access switch ("—" not displayed).

Exiting the Menu without Storing Code Changes

Changes to the code settings are not stored if you turn off the balance by pressing [OFF] while selecting the code numbers or before pressing [TARE] to save a setting.

Undoing All Menu Code Changes – Reset Function

The reset function lets you undo all menu code changes, which means that you will obtain the original factory-set menu codes identified by an ".*." To use this function, select code 9 -- 1°. See the previous page for information on confirming and storing a menu code setting.

Reset function	Code
On	9 -- 1
Off	9 -- 2

* including the Signatories of the Agreement on the European Economic Area

13. Check the scale units of measure. The factory default should be "grams (g)". A "g" will be displayed in the scale's window to the right of the numbers.

Scale set up is complete.

SET UP Temperature Controller

Set Up Heat - Watlow

The Watlow temperature controller is used to control heat for various dispenser hardware options: work area heater, material heater, needle heater, etc. To set up a temperature controller, refer to the OEM documentation.

Recovering Settings - Watlow

Several layers of settings have probably been set up and saved to fully customize the Watlow temperature controller for your custom application. If these settings have been changed inadvertently, you have two recovery options:

Option #1





Perform the following *Retrieve Factory Settings* procedure.

Option #2

If a more radical recovery is required, perform the *Re-Establish Factory Settings* procedure.

Retrieve Factory Settings

To reset the temperature controller settings back to the factory values, input the following values:

1. Press the UP and DOWN keys for 6 seconds until the display reads: 
2. Press the UP key until the display reads: 
3. Press the ADVANCE key until the display reads: 
4. Press the UP key until the display reads: 
5. Press the ADVANCE key until the display reads: 
6. Press the INFINITY key 2 times to save values.

Re-establish Factory Settings





Reestablishing settings for the temperature controller back to factory values requires these basic steps:

1. Set the Watlow factory values.
2. Set the GPD factory values and save all factory settings to Set 1.

1. Set Watlow Factory Settings





To reestablish Watlow factory settings:

1. Press the UP and DOWN keys for 6 seconds until the display reads: 

2. Press the UP key until the display reads: 
3. Press the ADVANCE key until the display reads: 
4. Press the DOWN key until the display reads: 
5. Press the ADVANCE key until the display reads: 
6. Press the INFINITY key 2 times to save values.

2. Set GPD Factory Settings & Save All Factory Settings

To reestablish GPD factory settings and save both Watlow and GPD factory settings to Set1:

1. Press the UP and DOWN keys for 6 seconds until the display reads: 
2. Press the UP key until the display reads: 
3. Press the ADVANCE key until the display reads: 
4. Press the UP key until the display reads: 
5. Press the ADVANCE key until the display reads: 
6. Press the INFINITY key 2 times to save values.

Set Up Heat - CAL 9900

To set up a new CAL 9900 temperature controller:

1. Read the CAL 9900 Temperature Controller OEM documentation.
2. Install the temperature controller unit and turn on the dispenser. The temperature controller's display will read "0.16" and the "0" will be flashing. The "16" represents function 16; the "0" represents the device option setting.

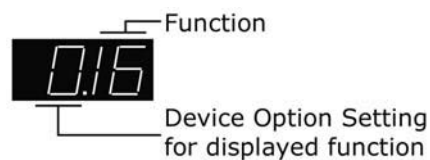

3. Replace the flashing "0" by pressing the [↑] button until the desired value displays. For example, to set function 16, press the [↑] button nine times. The display would then read "9.16".



4. Press the [*] button to change to option selection.

5. Press the [↑] or [↓] button to select the option required. For example, to select function 17, press the [↑] button once.
6. Press [*] to change to function selection.
7. Set an option setting for all applicable temperature controller functions.
8. When selections are complete, press [P] to exit program mode.

SET UP User Controls Access

Many user controls (buttons, check boxes, etc.) are *access controlled*, meaning they can be made active/inactive based on current access rights. For details about access rights, refer to the *FLOware Software Guide*.

To modify the access levels associated with the controls displayed for the user, open the directory `/appl/lib/app-defaults` and note these two files: `.DSmain` and `.DSedit` (use the `-a` switch on the `ls` command to see these files). These files are *widget access rights tables* for the two primary processes: `DSmain` and `DSedit`.

Table Structure

The `.DSmain` table shown here as an example of the structure used by widget access rights tables.

- Blank lines are ignored. Lines beginning with `#` are comments. All other lines are considered data and must be correctly formed.
- The first column (typically a name preceded by an asterisk) is a *widget path* or *widget name*. These represent items on the screen with which the user may interact (buttons, check boxes, etc.) and are named to indicate their purpose.
- The second column determines if the widget is managed (M) or sensitive (S). M and S are the only values allowed here.

```
#
#                               L R       T   P   M C
#                               i e       C P c U r   B o l
#                               v s T   o a h p g C a d a
#                               e t w S   n s P d I a c T s
#                               o i e e R A o e a f s a a n l k b S
#Widget Path   d n l a u d r a v i w t t f i u l e
#Name          e t l d n j e k e g d t e o b p s l
#-----

#                               MAIN PANEL
# Action pushbuttons:
*SelectProgBtn S Y - Y Y - - - - - - - - - - - -
*RunProgBtn   S Y - - Y - - - - - - - - - - - -
*RestartProgBtn S Y - - Y - - - - - - - - - - - -
*PauseProgBtn S Y - - Y - - - - - - - - - - - -
*CancelProgBtn S Y - - Y - - - - - - - - - - - -
*TestToggle   M Y - - - - - - - - - - - - - - - -
*JogBtn       M Y - - Y - - - - - - - - - - - -
*MntBrdBtn    M Y - - Y - - - - - - - - - - - -
*RefreshBtn   M Y - - Y - - - - - - - - - - - -
*GoHomeBtn    M Y - - Y - - - - - - - - - - - -
*TweakBtn     S Y - - - Y - Y - - - - - - - - - -
*doShapeCal   S Y - - - - - - - - - - - Y - - - -

# Run mode radio buttons:
*RunContinuous S Y - - Y - - - - - - - - - - - -
*RunBoard      S Y - - Y - - - - - - - - - - - -
*RunStep       S Y - - Y - - - - - - - - - - - -
*RunLoop       S Y - - Y - - - - - - - - - - - -

# Inspection mode radio buttons:
*RunOnly       S Y - - Y - - - - - - - - - - - -
*InspctOnly    S Y - - Y - - - - - - - - - - - -
*InspctDry     S Y - - Y - - - - - - - - - - - -
*InspctFull    S Y - - Y - - - - - - - - - - - -
```

- M (managed) widgets are made visible or invisible depending on their accessibility. If access is denied, they become invisible.
- S (sensitive) widgets turn gray when they are inaccessible.
- All subsequent columns contain a code that either allows or disallows the widget for a specific access right. Each column is described in the comments at the top of the table.
- To enable a widget for a specific access right, place a **Y** in that widget column. All other columns should have a dash (-) in them indicating “not applicable”.

In the table example shown above, the line beginning with `*doShapeCal` enables the Shape Calibration feature/button **only** when the current access rights include Maintenance and/or Calibrate. If the current user does not have these privileges, the Shape Calibration button turns gray because it is set to sensitive (S).

Also notice the entry starting with `*GoHomeBtn`. It is set to managed (M) so it is made invisible if the current user does not have the Run and/or Maintenance privilege.

Testing Procedures

TEST Barcode Scan Program

To test/validate that the mappings file for the Barcode Scan Program is correct, examine the log file while editing the mappings file and scanning codes to provide immediate feedback.

NOTE: Instructions for using and editing Barcode Scan Program Select (PN 2050-0094) are detailed in *Tips & Tricks - Barcode Scan Program* in the *Dispenser User Guide*.

To watch the log file in real time:

1. Open a shell window and type:

```
tail -f /appl/etc/logs/partno-reader.log
```

2. With the above command running, scan a code to display the code and the mapped dispenser program.

If the scanned code is malformed (invalid product code) or not found in the mappings file, error messages explaining the failure will display.

NOTE: The mappings file is loaded when a scan is received so to validate changes to the mappings file, a scan must be performed. After the scan is received, the changed mapping file is loaded and the result displayed.

3. If you cannot resolve a mappings file issue with the preceding testing procedural steps, contact the GPD Global Service Department and request help with configuring PN 2050-0094 Barcode Scan Program Select.

TEST Contact Surface Sensor

The contact surface sensor must operate properly or damage to your product and the mounted dispense pumps may result.

To verify that the touch probe opto switch functions properly:

1. To prevent inadvertent damage to product and equipment when firing the surface sensor during the following procedure, move all axes of the gantry to a safe position. Clicking REFRESH on the main button bar will move the gantry to the front of the machine.
2. Locate the opto switch for the contact surface sensor (located between head mount positions 1 and 2).
3. From the main menu bar, click Machine Controls > CustomCtrls.
4. From the popup menu, click Touch Probe Up/Down to activate the opto switch. The touch probe should descend and retract through its full stroke.

TEST Safety Interlocks

Test all safety shields to verify operations of the complete safety interlock system. All machine movement should stop (and any active program will abort) when a safety shield or safety shield door is opened during machine operations. If a safety interlock proves to be faulty, replace it.

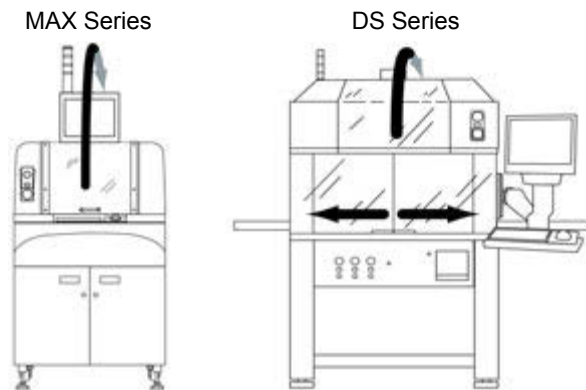

To test operation of a safety interlock:

1. Initiate the homing sequence by powering the machine off and on. Refer to [Power Off](#) (pg 3.4) and [Power On](#) (pg 3.1).
2. While the axis motors are homing, open the safety shield.
3. Observe the results:
 - The gantry should stop moving.
 - If gantry movement fails to stop, a safety interlock may be faulty. Test the switch function to confirm (1) proper wiring connections and (2) proper alignment with the key side of the interlock. If a safety interlock is found to be faulty, replace by following the [REMOVE / REPLACE Safety Interlocks](#) (pg 5.89).
4. Repeat the above procedure for each safety interlock.

TEST Touch Pad

The calibration station touch pad sensor must be operational for the needle Z position to calibrate properly.



To verify that the touch pad sensor functions properly:

1. Gently press down on the top of the touch pad, exerting only a light pressure while visually inspecting the base of the sensor mount where the sensor cable meets the mount — a red light should illuminate when the touch pad is touched/pressed. (Refer to the height switch mount block area.)
2. If the red light is not visible, the touch pad may need to be cleaned or the sensor light or sensor may be faulty. To clean the touch pad, refer to [CLEAN Touch Pad](#) (pg 5.69).

6 Troubleshooting



Troubleshooting procedures maintain the effectiveness of safety design features or devices (i.e., engineering controls). This section is intended for use by maintenance/service personnel. If a problem should arise that is not covered in this manual, contact:

GPD Global Service Department
 tel: (970) 245-0408
 fax: (970) 242-0520
 e-mail: request@gpd-global.com

Safety Instructions



WARNING

Procedures requiring access to the machine's interior should only be performed by qualified maintenance or technical personnel fully aware of all safety precautions.

Consignes de sécurité

AVERTISSEMENT

Les procédures exigeant l'accès à l'intérieur de la machine ne doivent être effectuées que par des personnes qualifiées du service technique ou de l'entretien connaissant parfaitement toutes les consignes de sécurité.

Sicherheitsanweisungen

ACHTUNG

Arbeitsvorgänge, bei denen auf das Innere der Maschine zugegriffen werden muß, dürfen nur von qualifiziertem Fachpersonal ausgeführt werden, das mit allen Sicherheitsvorkehrungen vertraut ist.

Istruzioni di sicurezza

AVVERTENZA

Le procedure che richiedono accesso all'interno dell'apparecchiatura devono essere eseguite soltanto da personale tecnico o qualificato per la manutenzione a conoscenza delle precauzioni di sicurezza.

Instrucciones de seguridad

ADVERTENCIA

Los procedimientos que requieren el acceso al interior de la máquina deben ser realizados por personal de mantenimiento o técnicos cualificados que conozcan las medidas de seguridad.



WARNING

Disconnect the power and air supplies prior to performing any machine maintenance whenever they are not required.

AVERTISSEMENT

Débrancher le courant et l'alimentation en air avant d'effectuer toute procédure exigeant l'accès à l'intérieur de la machine.

ACHTUNG

Vor der Durchführung von Arbeitsgängen, bei denen auf das Innere der Maschine zugegriffen werden muß, stets den Strom und die Luftzufuhr abschalten.

AVVERTENZA

Disinserire l'alimentazione e le forniture d'aria prima di eseguire qualsiasi procedura necessaria per accedere all'interno dell'apparecchiatura.

ADVERTENCIA

Antes de realizar cualquier procedimiento que requiera el acceso al interior de la máquina, desconecte la alimentación eléctrica y el suministro de aire.



IMPORTANT

Read all [Safety Notices](#).

IMPORTANT

Lire toutes les Instructions de sécurité.

WICHTIG

Alle Sicherheitsanweisungen lesen.

IMPORTANTE

Leggere tutte le Istruzioni di Sicurezza.

IMPORTANTE

Lea todas las Instrucciones de seguridad.

Indicators

The dispenser is equipped with automatic indicator systems, visual and/or auditory, to provide information about system operations and indicate machine status conditions and problems.

Messages

Messages provide running information about system operations or indicate when a problem arises.

- For system messages that may display on the dispenser monitor, refer to the *FLOware Software Information & Error Messages Reference Guide* (PN 22100026).
- For error messages that may be displayed by the CAL9900 temperature controller used by optional heated devices on the dispenser, refer to [Temperature Controller Error Messages](#) (pg 8.8).

Alarms

Visual and auditory alarm systems enable the system to associate certain conditions with a particular alarm mode. The status light tower indicates machine status conditions by turning on colored lights, each of which represents a given state. The audible alarm system can be local or remote, and is turned on and off at the machine. For details, refer to:

- [SET UP Alarms](#) (pg 5.90)
- *Safety Systems* in the *Dispense System User Guide*.

Symptom/Problem/Action

Use the following tables to help resolve problems that may occur. Potential symptoms are grouped into the following categories:

- [Overall Machine](#) (pg 6.3)
- [Conveyor](#) (pg 6.6)
- [Scale \(WMC-24 SH\)](#) (pg 6.8)
- [Scale \(CP*\)](#) (pg 6.8)
- [Pumps & Tools](#) (pg 6.9)

Overall Machine

Table 30: Troubleshooting - Overall Machine

Symptom	Possible Problem	Action
Alarm sounding.	Manually mounted item requires attention.	Read the prompt displayed on the screen to determine the nature of the problem and then remedy the condition. Refer to SET UP Alarms (pg 5.90).
	Machine has timed out.	
	Pump needs attention.	
	Fan failure in removable hard drive.	If optional, removable hard drive is present, refer to the Fan Failure section of Refer to SET UP Alarms (pg 5.90).
Machine is inoperative.	Power is off.	Power on the machine.
	Machine is unplugged.	Connect power per Installation (pg 2.1).
	Safety shield door or maintenance access window is open.	Close all safety shielding.
	Power failure or improper shut down has occurred.	<p>If a database error message displays or the screen is blank and the system does not power up:</p> <ol style="list-style-type: none"> 1. Turn off the appropriate control switch: the black Power Off button for a MAX Series unit, or the main power switch for a DS Series unit. IMPORTANT: Does your system use a legacy control panel? To find out, refer to Legacy Controls & Operations (pg 9.1) where alternative/legacy content is also available. 2. Wait several seconds. 3. Perform a normal power on. Refer to <i>Power On</i> in the <i>Dispense System User Guide</i>. 4. If the system does not power up normally, repeat the above steps once. If the problem continues, contact GPD Global.
	Blown fuse.	Replace fuse. Refer to REMOVE / REPLACE Fuses (pg 5.87).
<p>Numerous devices (conveyor, trace cut drill motor, debris vacuum, touch pad sensor, status light tower, etc.) could have blown the fuse, with the results that none of them function.</p> <p>Replace fuse. Refer to REMOVE / REPLACE Fuses (pg 5.87).</p>		
	System is inoperable due to factors such as a corrupted hard drive.	System software and data can be restored provided the necessary backups are available. Refer to <i>Dispenser Software Recovery</i> PN 22100109CD.29 for detailed instructions.
Machine is inoperative but monitor and computer remain on.	Blown fuse.	Replace fuse. Refer to REMOVE / REPLACE Fuses (pg 5.87).
Machine is stopped.	End of cycle.	Unload product and, if applicable, start a new cycle.
	Safety shield door or maintenance access window is open.	Close all safety shielding.
	Blown fuse.	Replace fuse. Refer to REMOVE / REPLACE Fuses (pg 5.87).
Machine is unresponsive to software commands.	Blown fuse.	Replace fuse. Refer to REMOVE / REPLACE Fuses (pg 5.87).

Table 30: Troubleshooting - Overall Machine

Symptom	Possible Problem	Action
Machine will not boot.	No power to the optional, removable hard drive may indicate that the key lock for the drive may be turned off.	Verify that the key lock is turned to the ON position and the green power LED is lit. Refer to COMPUTER Removable Hard Drive in Special Topics.
	No power to optional removable hard drive may indicate a connection may be loose.	If turning the key lock to ON did not remedy the condition, inspect for a loose connection.
	Removable hard drive is not recognized by computer.	Check for loose connection. Check the Master/Slave configuration for proper mode setting.
Safety shield door will not close.	Obstruction is present or safety key cannot engage in switch.	Clear obstruction.
Error message displays during operations.	System has encountered a problem.	For instructions specific to the displayed error message, refer to <i>FLOware Software Information & Error Messages Reference Guide</i> (PN 22100026).
	Temperature controller has encountered a problem.	For instructions specific to the displayed error message, refer to Temperature Controller Error Messages (pg 8.8).
Error message is encountered during homing sequence.	System was left in a bad state (gantry moved manually) or a home optical limit switch is not working properly.	Click RETRY if an error message is displayed and provides this option.
		Inspect optical limit switches for bent flags. Straighten the bent flag. To locate switches, refer to the gantry assembly drawing in <i>Mechanical & Electrical Reference Documents</i> .
		Connector may have come unplugged from optical limit switch. Plug connector back into optical limit switch.
		To locate switches, refer to the gantry assembly drawing in <i>Mechanical & Electrical Reference Documents</i> .
		If optical limit switch is defective, replace switch. To locate switches, refer to the gantry assembly drawing in <i>Mechanical & Electrical Reference Documents</i> . Z axis switch - To access the switches, remove the z axis motor by removing four bolts and laying the motor aside. All switches - To locate switches, refer to the gantry assembly drawing in <i>Mechanical & Electrical Reference Documents</i> .
Safety message is encountered.	Safety shield is open.	Close all safety shielding.
	Low air pressure.	Inspect air pressure and correct as necessary.
	An overrun optical limit switch is not working properly or is defective.	Inspect optical limit switches for bent flags and straighten as needed. To locate switches, refer to the gantry assembly drawing in <i>Mechanical & Electrical Reference Documents</i> . Connector may have come unplugged from optical limit switch. Plug connector back into optical limit switch. To locate switches, refer to the gantry assembly drawing in <i>Mechanical & Electrical Reference Documents</i> . If optical limit switch is defective, replace switch. To locate switches, refer to the gantry assembly drawing in <i>Mechanical & Electrical Reference Documents</i> . To access the Z axis switch, remove the z axis motor by removing four bolts and laying the motor aside.
Gantry movement fails to stop when a safety shield is opened.	Safety interlock may be faulty.	Verify safety interlock operation and replace if safety interlock is faulty. For details, refer to REMOVE / REPLACE Safety Interlocks (pg 5.89).

Table 30: Troubleshooting - Overall Machine

Symptom	Possible Problem	Action
Gantry fails to move but motor runs continuously.	A coupler may be loose or broken. Inspect couplers and tighten as necessary.	For locations and part numbers, refer to the gantry assembly drawing(s) in <i>Mechanical & Electrical Reference Documents</i> .
Gantry movement fails for all axes.	Blown fuse. Replace fuse.	Refer to REMOVE / REPLACE Fuses (pg 5.87).
Gantry movement fails for an individual axis.	Blown fuse.	Replace fuse. Refer to REMOVE / REPLACE Fuses (pg 5.87).
X and/or Y gantry travel are stiffer than normal.	Ball screw travel nut is binding.	<ol style="list-style-type: none"> Loosen the bolts securing the bearing blocks to the gantry mount plates (refer to gantry or axis assembly drawing(s) in <i>Mechanical & Electrical Reference Documents</i>). Move gantry through its full travel path to align it. Tighten the bolts.
	Ball screw travel nut binding requires lubrication.	Clean all leads screws (refer to gantry or axis assembly drawing(s) in <i>Mechanical & Electrical Reference Documents</i>) with acetone or its equivalent. Then apply a light coat of GPD Global approved Teflon Gel Lubricant (Part No. 10/0928 or 10/1844).
X and/or Y gantry travel is jammed.	Obstruction is present or gantry is mechanically bound.	<p>Inspect for and remove obstructions. If gantry is bound up, realign and lubricate, and then test for free movement.</p> <p>To realign a bearing block, loosen the four bolts. The block should pop into correct alignment. Tighten the bolts and check the gantry for free movement.</p> <p>A mechanical problem may require replacing a linear rail.</p>
	Requires lubrication.	<ol style="list-style-type: none"> Turn off (O) main power. Inspect lead screw pathways (refer to gantry or axis assembly drawing(s) in <i>Mechanical & Electrical Reference Documents</i>). Contact GPD Global.
Camera is inoperative and/or camera light is dark.	A connection is loose or improperly installed.	<p>Check that all cables are connected properly.</p> <p>ClearVu Vision option only: Check that motors and sensors are connected to the proper location on the junction box.</p> <p>ClearVu Vision option only: Check that the port setting in the software is the same as the COM port to which the DB-9 and DB-25 cables are connected.</p>
	Blown fuse.	Replace fuse. Refer to REMOVE / REPLACE Fuses (pg 5.87).
Camera is not finding fiducial patterns.	Camera focus or aperture setting has been altered after fiducial patterns were established.	<p>Perform all calibration procedures fully whenever prompted during processing; never use the Skip Calibration option, OR</p> <p>Especially for high accuracy work: Reteach all vision patterns and then, for each program, perform the full calibration procedure the next time the program is run.</p>
	Camera vision capabilities need to be heightened.	Change level of light intensity, lighting color, or type of illumination. Refer to <i>Lighting Controls</i> in the <i>FLOware Software Guide</i> .
Camera carriage sticks or does not slide smoothly.	The slide and actuator probably need to be cleaned.	Refer to the cleaning instructions for the specific model of optional Lipstick Camera hardware installed - see the data sheets listed under Passive Camera (pg 5.22).
Video images contain flare, blooming, or smear (vertical stripe).	Camera lens may be dirty.	Clean the camera lens per CLEAN Camera Lens (pg 5.60).
	Camera is aimed at bright light or light-reflecting object.	Never aim the camera directly at bright objects, whether the camera is in use or not.

Table 30: Troubleshooting - Overall Machine

Symptom	Possible Problem	Action
Monitor screen is dark.	Monitor power button, if present, is not turned on.	Turn on monitor power button.
	Monitor power connector is unplugged.	Check cable connection on back of monitor.
	Monitor video connector is unplugged.	Check monitor power indicator light on front of monitor and: <ul style="list-style-type: none"> • If lit, check video cable port on back of computer. • If not lit, plug cable into back of monitor.
	Video card is defective.	Inspect computer cable terminations on back of computer.
	Blown fuse.	Replace fuse. Refer to REMOVE / REPLACE Fuses (pg 5.87).
Work area does not heat.	Temperature controller not set to adequate temperature.	Enter proper temperature setting. Refer to ADJUST Temperature Controller (pg 5.35).
	Circuit breaker has been tripped.	Reset circuit breaker.
	Blown thermal cut out switch due to over temperature condition.	Replace thermal cut out switch.
	Faulty solid state relay.	Replace solid state relay.
	Faulty heating element.	Replace heating element.
	Heater power not turned on.	Turn on heater power with side panel enclosure power switch and temperature controller software I/O. Refer to IO Viewer (pg 4.12).
Temperature controller remains dark when software I/O attempts to power it on.	Blown fuse.	Replace fuse. Refer to REMOVE / REPLACE Fuses (pg 5.87).
	An individual device is inoperative.	Replace fuse. Refer to REMOVE / REPLACE Fuses (pg 5.87).

Conveyor

Table 31: Troubleshooting - Conveyor

Symptom	Possible Problem	Action
Unsatisfactory product transfer rate.	Conveyor speed not synchronized with upstream/downstream conveyor.	Adjust conveyor speed per ADJUST Conveyor Speeds (pg 5.25).
Product is not traveling smoothly along conveyor.	Conveyor belts slipping.	Adjust conveyor belt tension per ADJUST Conveyor Belt Tension (pg 5.23).
	Conveyor rails are positioned too closely together	Adjust width between the rails.
	Obstruction in conveyor path.	Remove obstruction.
Interference from belt during product transfer process.	Belts worn or frayed.	Inspect and, if necessary, replace belts per REMOVE / REPLACE Conveyor Belt (pg 5.86).
Product contamination from belt fibers.		
Conveyor belt tension pulley is at the end of its take-up travel.		
Conveyor width adjust is binding.	Obstruction.	Check the adjustable rail and remove obstruction.

Table 31: Troubleshooting - Conveyor

Symptom	Possible Problem	Action
Conveyor width will not adjust.	Board data has not been defined in the program.	Enter board data in program. Refer to Automatic Width Adjust under ADJUST Conveyor Width (pg 5.30).
	Sensor sensitivity may need to be adjusted.	Adjust sensor sensitivity per ADJUST Conveyor Sensor Sensitivity (pg 5.24).
	Blown fuse.	Replace fuse. Refer to REMOVE / REPLACE Fuses (pg 5.87).
Stop pins firing at improper times.	Conveyor speed may have been changed but not calibrated.	Perform ADJUST Conveyor Speeds (pg 5.25) and CALIBRATE Conveyor Speeds (pg 5.46).
Transfer time out message (R07) displays.	Upstream/downstream machine not ready, causing delay in board transfer.	Make the offending machine ready and click CONTINUE to continue or ABORT to abort the program. If problem recurs, increase the option WaitForBoard or WaitForRelease to conform to the actual speed of the line.
	Conveyor speed may have been changed but not calibrated.	Perform ADJUST Conveyor Speeds (pg 5.25) and CALIBRATE Conveyor Speeds (pg 5.46).
Premature product release from entry/exit or nest position.	Fiber optic amplifiers require cleaning and/or adjustment.	<ul style="list-style-type: none"> Inspect for debris or any foreign material obstructing the lens. Clean lens with a soft dry cloth. To verify a good signal and, if necessary, adjust an amplifier, refer to ADJUST Conveyor Sensor Sensitivity (pg 5.24).
	Blown fuse.	Replace fuse. Refer to REMOVE / REPLACE Fuses (pg 5.87).
Conveyor stop pins fail to return to "hold" position.	Fiber optic amplifiers require cleaning and/or adjustment.	<ul style="list-style-type: none"> Inspect for debris or any foreign material obstructing the lens. Clean lens with a soft dry cloth. To verify a good signal and, if necessary, adjust an amplifier, refer to ADJUST Conveyor Sensor Sensitivity (pg 5.24).
	Mechanically bound up.	Inspect for and remove cause of binding.
	Blown fuse.	Replace fuse. Refer to REMOVE / REPLACE Fuses (pg 5.87).

Scale (WMC-24 SH)

To verify the actual weight of a weigh unit and, as needed, adjust/calibrate the weigh unit value used by the scale, use the Verify & Adjust/Calibrate 4-Place Scale Weight Kit (PN 22213007) and included procedure.

For all other weigh scale issues, contact GPD Global.

Scale (CP*)

Table 32: Troubleshooting - Scale (CP)

Symptom	Possible Problem	Action
No segments appear on the display.	No AC power is available. The AC adapter is not plugged in.	Check the AC power supply. Plug in the AC adapter.
H	The load exceeds the scale capacity.	Unload the scale.
L or Err 54	Something is touching the load plate.	Move the object that is touching the load plate.
Err 01	Data output not compatible with output format.	Change the configuration in the operating menu.
Err 02	Calibration parameter not met; e.g.: - scale not zeroed - scale is loaded	Calibrate only when zero is displayed. Press TARE to zero the scale. Unload the scale.
Err 10	The TARE key is blocked when there is data in the second tare memory (net-total) - only 1 tare function can be used at a time.	Press CF to clear the tare memory and release the tare key.
Err 11	Tare memory not allowed.	Press TARE.
Err 22	Weight is too light or there is no sample on the scale.	Increase the weight on the scale.
Err 30	Interface port for printer output is blocked.	Reset the menu (restore factory settings) or contact GPD Global.
The weigh readout changes constantly.	Unstable ambient conditions. A foreign object is caught between the load plate and the scale frame.	Set up the scale in another area. Remove the foreign object.
Incorrect or inaccurate weight reading.	The scale hasn't been calibrated.	Calibrate the scale in another area.
	Scale wasn't zeroed before weighing.	Tare or zero the scale before weighing.
	Scale surface is not level.	Level the surface of the scale. Refer to ADJUST Scale to Level (pg 5.34).

*Error codes display on main display for 2 seconds before program returns automatically to the previous mode (e.g., weighing).

Pumps & Tools

The following tables of problems and solutions will assist in improving your dispensing operation. Most problems can be traced to the dispense material, especially when encountering problems with solder paste dispensing.

EXCEPTIONS:

- Micro-Dot Pump - refer to the *Micro-Dot Pump Guide* (p/n 22110265M).
- PCD Pump - refer to the *PCD Pump User Guide* (p/n 22293078M).

DS SERIES:

- Dispenser mount position 1 is stationary.
- Mount positions 2 and 3 are 1" (25,40 mm) **above** position 1 on a pneumatic cylinder with a vertical travel stroke of approximately 2" (50,80 mm).
- At maximum stroke, positions 2 and 3 are approximately 1" (25,40 mm) **below** position 1 and any other inactive tools/pumps.

Table 33: Troubleshooting - Pumps & Tools

Symptom	Possible Problem	Action
Dispensed volumes/shapes are inconsistent in size.	AUGER PUMP and/or material	<ul style="list-style-type: none"> • Verify proper air pressure is present. • Decrease gap by reducing Start Z value in Program Detail for applicable program line. • Increase dwell by increasing On Time value in Program Detail for applicable program line. • Create a braking (shorting) or reverse motor action using Auger Idle and Auger Reverse on the Program Mount Table.
	NEEDLE PUMP - air seepage from air body assembly.	<ul style="list-style-type: none"> • Worn O-rings. • Loose assembly. • Bad air connection.
Dispensed volumes/shapes are too large.	AUGER PUMP and/or material	<ul style="list-style-type: none"> • Use a smaller tip. • Verify proper air pressure is present. • Increase gap to avoid "squashing" the dot by increasing Start Z value in Program Detail for applicable program line.
Dispense tip is plugging or clogging.	Insufficient gap for shot size.	Increase gap by increasing Start Z value in Program Detail for applicable program line.
	AUGER PUMP tip contacting substrate during dispense cycle.	Increase gap by increasing Start Z value in Program Detail for applicable program line.
	AUGER PUMP tip is bent or damaged.	Replace auger dispense pump tip.
	Excessive paste for size of needle.	Decrease motor run time by reducing On Time value in Program Detail for applicable program line.
	Overfeeding the feed screw.	Decrease air pressure applied to syringe at dispense control panel.
Paste has separated, exceeded shelf life, or has poor particle size distribution (-200+325 spec).	Replace with fresh barrel of paste or seek an alternate supplier.	

Table 33: Troubleshooting - Pumps & Tools

Symptom	Possible Problem	Action
Inconsistent results, repeatability is not meeting specifications.	Air bubbles may be trapped in needle.	Clear air bubbles out of needle following the PURGE Pumps (Online) (pg 5.78).
	MICRO-DOT PUMP - inadequate air pressure may result in voids on lead screw and at needle tip.	Increase air pressure. Refer to <i>Micro-Dot Pump Manual</i> (part number 22110265M).
	Inconsistent characteristics in material or product.	Inspect for material and product-related factors that may be affecting processing results.
	Needle Pump - Material leaking from tip of pump.	Replace worn pump needle, worn or bad seat, or worn o-ring on seat.
	SPOOL PUMP - inconsistent material flow.	Inspect for and correct the following possible causes: <ul style="list-style-type: none"> • Inconsistent operating air pressure. • Inconsistent material pressure. • Operating air pressure is too low - increase to 50 psi. • Air is trapped in fluid housing - purge the pump. • Length of actuation is too short - increase shot time.
	An encoder may be loose or electronically defective.	Inspect encoders and correct problem (broken wire, loose coupling, defective encoder). For location and part numbers, refer to the gantry assembly drawing(s) in <i>Mechanical & Electrical Reference Documents</i> .
Inconsistent dispense height over the surface of the product.	Calibration station touch pad requires cleaning.	Clean touch pad. Refer to CLEAN Touch Pad (pg 5.69).
	Touch probe tip is damaged or sticking in its mount.	Remove and clean or replace the touch probe tip per CLEAN Touch Probe (pg 5.70).
	Inadequate number of surface sensing points.	Increase the number of surface sensing points in the program or use a standoff needle.
	Work area surface may not be level.	Verify levelness of nest area and, as necessary, level it using the Setup & Leveling Kit and the applicable instructions: ADJUST Work Area Lifter Plate (pg 5.38) or ADJUST Work Area Tooling Plate (pg 5.43).
Dispense height is far above product surface	Touch probe tip is damaged or sticking in its mount.	Remove and clean or replace the touch probe tip per CLEAN Touch Probe (pg 5.70). To verify proper function of the opto switch, contact the GPD Global Service Department for help. For switch location, refer to Contact Surface Sensor Assembly drawing in <i>Mechanical & Electrical Reference Documents</i> .
Broken needle or product	Calibration station touch pad requires cleaning or replacement.	Clean touch pad, as needed, replace. Refer to CLEAN Touch Pad (pg 5.69).
Dispense not occurring in correct locations		
Pump fails to stop descent.		

Table 33: Troubleshooting - Pumps & Tools

Symptom	Possible Problem	Action
Inoperable height sensing.	Calibration station touch pad requires cleaning.	Clean touch pad. Refer to CLEAN Touch Pad (pg 5.69).
	Touch probe tip is damaged.	Remove and clean or replace the touch probe tip per CLEAN Touch Probe (pg 5.70). To verify proper function of the opto switch, contact the GPD Global Service Department for help. For switch location, refer to Contact Surface Sensor Assembly drawing in <i>Mechanical & Electrical Reference Documents</i> .
	Improperly set plungers in the touch probe mount cause touch probe tip to wedge in its up position when the station's air cylinder fires.	Using a screwdriver, adjust the plungers on the front and side of the touch probe mount until the touch probe tip moves up and down freely without falling out of the mount.
No air or control of air from dispense control panel.	Blown fuse.	Replace fuse. Refer to REMOVE / REPLACE Fuses (pg 5.87).
Material leaking from tip.	MICRO-DOT PUMP - material is bleeding from dispense tip when machine is idle.	<ul style="list-style-type: none"> Inspect for excessive air pressure and, as needed, reduce air pressure. Refer to <i>Micro-Dot Pump Manual</i> (part number 22110265M). If trapped air in the cartridge is causing bleeding from the dispense tip, purge material from the pump until bleeding stops.
	NEEDLE PUMP - worn pump needle, worn or bad seat, or worn O-ring on seat.	Replace worn part(s).
	NEEDLE PUMP - pump will not close.	Inspect for and correct the following possible causes: <ul style="list-style-type: none"> Dried material obstructing the needle. Packing nut is too tight. Air lines are not connected properly.
	SPOOL PUMP - steady drip.	Inspect for and correct the following possible causes: <ul style="list-style-type: none"> Suck Back Cap fully closed - unscrew cap until dripping stops. Damaged spool and/or seals - replace worn or damaged parts. Excessive material pressure - lower material pressure. Pump was reassembled incorrectly after cleaning. Reassemble per CLEAN Spool Pump (pg 5.74). Actuating air pressure is not properly exhausted - check pneumatic circuit. Return spring is missing or damaged - replace spring.
Material seepage.	MICRO-DOT PUMP - seepage from needle may indicate excess air pressure or entrapped air.	Reduce air pressure to decrease the amount of force used to move material through the lead screw. Refer to <i>Micro-Dot Pump Manual</i> (part number 22110265M).
	NEEDLE PUMP - seepage around packing nut may indicate a loose packing nut or worn packing	Tighten packing nut or, as needed, replace.

Table 33: Troubleshooting - Pumps & Tools

Symptom	Possible Problem	Action
No material flow.	AUGER PUMP - blown fuse or defective auger pump.	Replace fuse. Refer to REMOVE / REPLACE Fuses in Periodic Operations. Repair/replace auger pump.
	MICRO-DOT PUMP -clogged lead screw and/or needle.	Air pressure may be excessive and/or the pump may require cleaning. Refer to <i>Micro-Dot Pump Manual</i> (part number 22110265M).
	NEEDLE PUMP - piston will not cycle.	Inspect for and correct the following possible causes: <ul style="list-style-type: none"> • Verify proper receptacle connection. • Insufficient air pressure to syringe. • Packing nut is too tight. • Stroke is set too low. • Dried material in fluid body.
	SPOOL PUMP - improper air or material pressure or pump is clogged or closed.	Inspect for and correct the following possible causes: <ul style="list-style-type: none"> • Verify proper receptacle connection. • Insufficient air pressure to syringe - increase air pressure to 50 psi. • Material pressure is too low - increase material pressure. • Material is cured or clogged in pump - clean pump per Cleaning Pumps (pg 5.71).

7 Specifications

Specification data is detailed in this section for these systems:

- [MAX Series Specifications](#) (pg 7.2)
- [DS Series Specifications](#) (pg 7.12)
- [Weigh Scale](#) (pg 7.20)

MAX Series Specifications

Dimensions & Weight

Dispense Area (X, Y, height)

Table 34: Dispense Area by Model

Dispense Area Type	Model	Mount Position 1 (X, Y, height)	Mount Position 2* (X, Y, height)
Non-heated	MAX Series	36 cm x 31 cm x 8 cm (14.1" x 12" x 3.25")	31 cm x 31 cm x 8 cm (12" x 12" x 3.25")
Heated	MAX II Series		

*Based on a single camera, a surface sensor, and a valve in each mount position.

Machine Footprint

Additional dimensions detail is available on following pages.

Table 35: Footprint Dimensions by Model

	Model	Dimensions (WxDxH)	Crated Weight (approximate)
Non-Heated	MAX Series	94 cm x 119 cm x 199 cm (36.9" x 47" x 78.5")	1021 kg (2,250 lbs)
	MAX II Series	93 cm x 119 cm x 199 cm (36.6" x 47" x 78.5")	1089 kg (2,400 lbs)
Heated	MAX II Series with Pre-heat*	115 cm x 119 cm x 199 cm (45.2" x 47" x 78.5")	1098 kg (2,420 lbs)
	MAX II Series with Post-heat*	113 cm x 119 cm x 199 cm (44.4" x 47" x 78.5")	1266 kg (2,790 lbs)
	MAX II Series with Pre- & Post-heat*	135 cm x 119 cm x 199 cm (53.0" x 47" x 78.5")	1275 kg (2,810 lbs)

* Assuming left-to-right board travel.

Crated Specifications

Table 36: Crate Specifications by Model

	Model	Dimensions (WxDxH)	Crated Weight (approximate)
Non-Heated	MAX Series	130 cm x 160 cm x 183 cm (51" x 63" x 72")	1021 kg (2,250 lbs)
Heated	MAX II Series	FROM 130 cm x 160 cm x 183 cm TO 178 cm x 160 cm x 183 cm (FROM 51" x 63" x 72" TO 70" x 63" x 72")	1089 kg (2,400 lbs)

Dimension Details - MAX

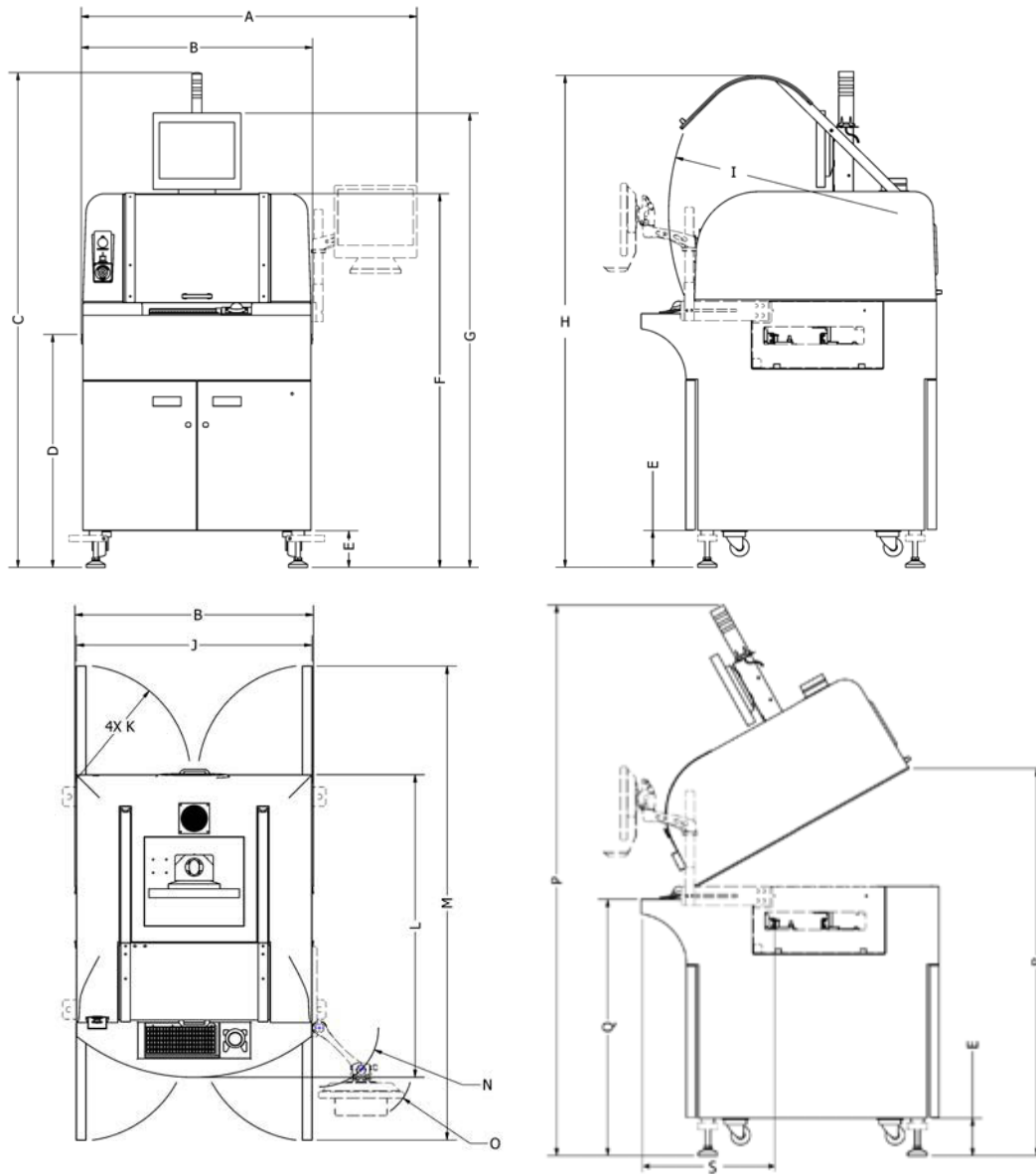

Table 37: MAX Series Dimensions Key

A*	† 136.0 cm (53.56"), ‡ 167.5 cm (65.93")	H	199.5 cm (78.53")	N*	† R23.2 cm (R9.13"), ‡ R40.9 cm (R16.12")
B	93.8 cm (36.91")	I	R92 cm (R36.3")	O*	† R19.9 cm (R7.83"), ‡ R51.0 cm (R20.07")
C	201.6 cm (79.38")	J	92.7 cm (36.48")	P	220.2 cm (86.71")
D	93.98 - 96.52 cm (37.0 - 38.0")	K	4x R44.7 cm (4x 17.60")	Q	102.8 cm (40.46")
E	15.0 cm (5.91")	L	119.1 cm (46.90")	R	155.0 cm (61.01")
F	152.3 cm (59.96")	M	186.7 cm (73.50")	S	533.9 cm (21.02")
G	185.1 cm (72.89")				

*Optional Adjustable Monitor Arm (swivel style shown)

† Maximum extension for Swivel style (PN 22291060 or 22291064)

‡ Maximum extension for Adjustable arm with stacked dual monitor style (PN 22291095)

NOTE 1: All vertical dimensions can be adjusted (together) ±2.5 cm (±1.00").

NOTE 2: Standard direction of flow is left-to-right, however, right-to-left is configurable at time of order.

Dimension Details - MAX II

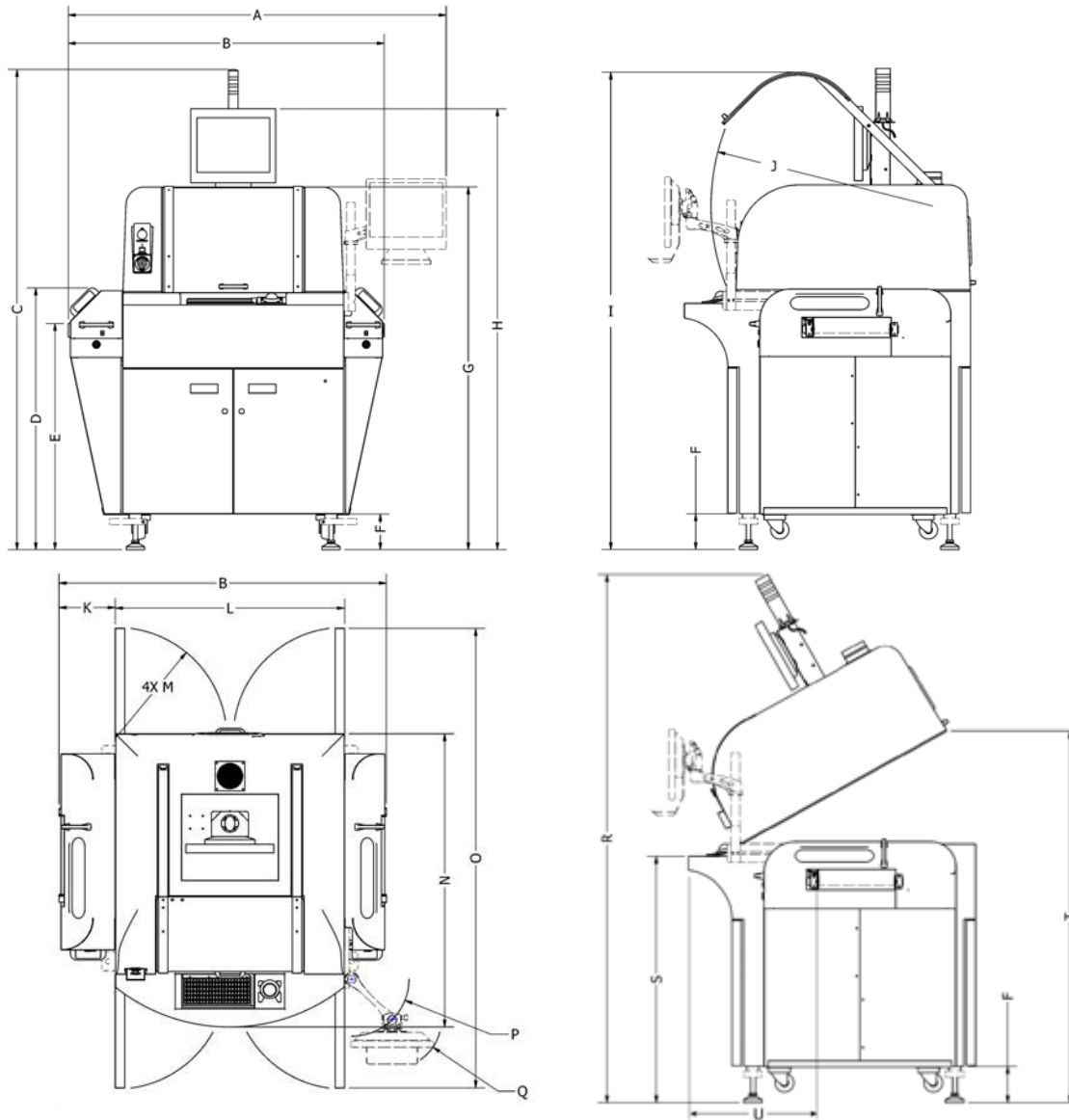

Table 38: MAX II Dimensions Key

A*	† 158.3 cm (62.30"), ‡ 167.5 cm (65.93")	H	185.1 cm (72.89")	O	186.7 cm (73.50")
B	132.3 cm (52.10")	I	199.5 cm (78.53")	P*	† R23.2 cm (R9.13"), ‡ R40.9 cm (R16.12")
C	201.6 cm (79.38")	J	R92 cm (R36.3")	Q*	† R19.9 cm (R7.83"), ‡ R51.0 cm (R20.07")
D	109.9 cm (43.25")	K	22.8 cm (8.96")	R	220.2 cm (86.71")
E	93.98 - 96.52 cm (37.0 - 38.0")	L	92.7 cm (36.48")	S	102.8 cm (40.46")
F	15.0 cm (5.91")	M	4x R44.7 cm (4x 17.60")	T	155.0 cm (61.01")
G	152.3 cm (59.96")	N	119.1 cm (46.90")	U	533.9 cm (21.02")

*Optional Adjustable Monitor Arm (swivel style shown)

† Maximum extension for Swivel style (PN 22291060 or 22291064)

‡ Maximum extension for Adjustable arm with stacked dual monitor style (PN 22291095)

NOTE 1: All vertical dimensions can be adjusted (together) ±2.5 cm (±1.00").

NOTE 2: Standard direction of flow is left-to-right, however, right-to-left is configurable at time of order.

NOTE 3: The number of exhaust ports (up to 3) is configuration dependent (pre-heat, nest, post-heat).

Clearance Dimensions

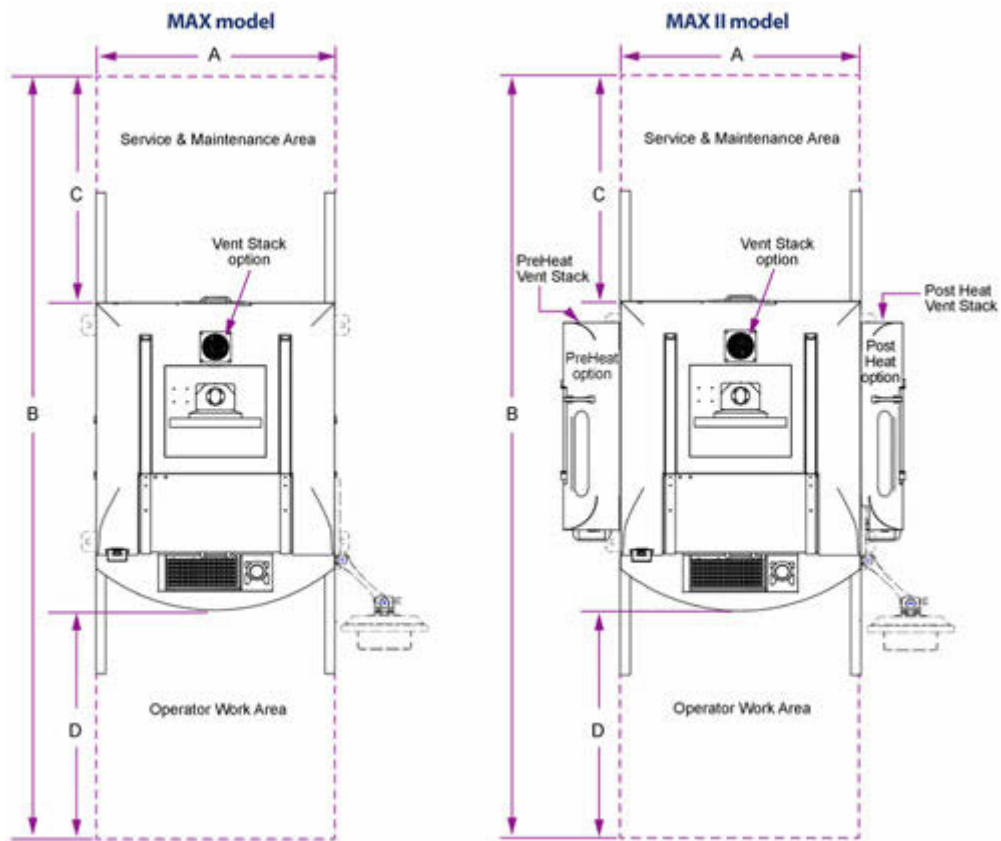

Table 39: Clearance Dimensions Key

A	93 cm	(36.5")
B	302 cm	(119.0")
C	91 cm	(36.0")
D		

Requirements

Power

Breaker/Fusing GPD Global recommends use of dedicated, external circuit breaker/fusing. Alternately, use properly rated branch fusing.

Power requirements by model Refer to Table 40.

Table 40: Power Requirements by Model

Model	Volts AC*	AC Frequency	Phase	Amps @ Volts (maximum)
MAX	120 Volts or 230 Volts‡	50/60 Hz	1Φ	10 amps @ 120 Volts or 5 amps @ 230 Volts
MAX II	230 Volts‡			13 amps @ 230 Volts

* ±10%
 ‡ 2-pole 3 wire ground
 NOTE1: To change input power, see [System AC Input Voltage Change](#) (pg 8.17).
 NOTE2: Hard wiring to machine is not possible.

SEMI S2 ratings Refer to Table 41.

Table 41: SEMI S2 Ratings

<i>Largest Single Load Amp</i>	2 Amp non-heated Up to 10 Amp heated	<i>Operating Amp</i>	5 Amp non-heated Up to 15 Amp heated	<i>Branch Circuit Over Protection Required</i>	20 Amp
<i>Short Circuit Interrupt Capacity of the main over-current protective device</i>	10K (AIC) typical. Check serial number label for actual value.	<i>System KAIC</i>	5K (AIC)	<i>IP Rating</i>	IP20
<i>Minimum Protective Earth Ground conductor size</i>	#14 AWG	<i>Electrical Diagram Drawing Number</i>	00015-222-04-xx	<i>Over Current Protection Provided at Machine Terminals</i>	

Power cable Customer supplies connection hardware to bare end of cable (refer to Table 42) per customer's facility requirements/specifications for needed voltage.

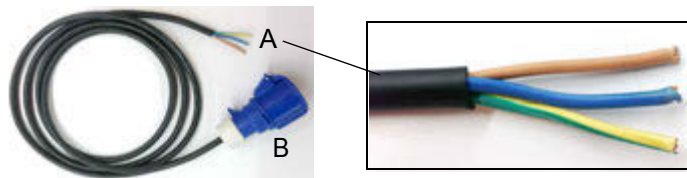

Table 42: Power Cable End Details

End	Description
A	brown, + *(line), 12 AWG (56/28) 4 mm ² blue, - (neutral), 12 AWG (56/28) 4 mm ² green/yellow, ground, 12 AWG (56/28) 4 mm ²
B	Power connector specific to GPD Global Dispense System

Air

Pressure (clean & dry air)	(552 kPa (80 psi))
Flow rate (maximum) - add flow from each vacuum system present:	
Machine	113 l/min @ 600 kPa (4 CFM @ 87 psi)
Nest vacuum	113 l/min @ 345 kPa (4 CFM @ 50 psi)
Preheat vacuum	113 l/min @ 345 kPa (4 CFM @ 50 psi)
Post-heat vacuum	113 l/min @ 345 kPa (4 CFM @ 50 psi)
Air lines	GPD Global recommends you have a dedicated air line for each feature requiring air; although if flow rate is high enough, a branched air line may be sufficient. <i>Most systems require two air connections (machine + nest vacuum).</i>
Air fitting thread	1/4" NPT <i>Customer supplies connection hardware.</i>

Ventilation

Exhaust port* diameter	101,6 mm (4") per port
	<i>* the number of ports is configuration dependent (pre-heat, nest, post-heat)</i>
	<i>* customer supplies ducting to exhaust port</i>
Ventilation flow rate	7,079 l/min (250 CFM) per port

Environmental

Pollution rating	Category 2, Pollution degree 2
Degree of protection	IP 43
Operating Temperature:	
Heated models	5°C to 40°C (41°F to 104°F)
Non-heated models	5°C to 40°C (41°F to 104°F)
Storage & transportation temperature	0°C to 60°C (32°F to 140°F)
Humidity (non-condensing)	< 50% @ 40°C
	<i>* maximum for operating</i>
Vibration (power supply)	To IEC 68-2.6 and BS2011 Part 2.1 Fc 1983.
EMI in compliance with	EN 61000-4-2, EN 50082-2, EN 61000-4-4, ENV 50140, ENV 50141, and EN 55011 class

Performance

Dispense rate*	45,000 DPH with LX Auger Pump
	<i>*based upon 1,27 mm (0.050") pitch, 1,000 dot matrix</i>
Accuracy**	±0.0254 mm (±0.001")
	<i>**with system mapping over standard work area</i>
Repeatability (per axis)	±0.0152 mm (±0.0006")
Acceleration	0.7G
Linear speed	69 cm/sec (27"/sec)
Z axis travel	82,6 mm (3.25")
Resolution (per axis)	±0,0051 mm (±0.0002")

Capacities

Product

Product Thickness (min/max)Varies; based on width of product and its rigidity.

Product Clearance*

Above board±25,4 mm (±1.0")

Below board±25,4 mm (±1.0")

**Custom configurations are available for both above and below board clearance. Standard above board clearance is determined by on-axis illumination and distance between dispense tip and probe. Standard below board clearance is determined by optional contact fixture and the sensor distance below the board.*

Conveyor-specific Product:

Load Capacity**, generic maximum 2 kg (4.41 lbs)

Board Carrier

Length***75 mm to 381 mm (2.95" to 15")

Width38 mm to 305 mm (1.5" to 12")

***A combination of various factors affect the amount of weight the conveyor can pull: belt width, belt material, the number of board stops in use, etc. Custom configurations are available to accommodate heavier load capacity.*

****Can be increased for custom configurations or reduced by using various board stop options.*

Conveyor

ComplianceAll dispenser models are in compliance with
[IPC SMEMA 9851](#) (pg 8.16)

Transport height (SMEMA specifications):

From floor to bottom of product. . . 94 cm to 97 cm (37" to 38")

Parallelism of rail at lead screw:

From lead screw to lead screw . . . 0,38 mm (0.015")

From lead screw to any
unsupported point on conveyor. . . 1,52 mm (0.060")

Width Adjustment38 mm to 305 mm (1.5" to 12")

Edge Clearance‡3 mm edge belt with tolerance > 5 mm per side
5 mm edge belt with tolerance > 7 mm per side

‡Custom edge belt clearance is available.

Heating

Heating Limits:

Dispense system. ambient to 150°C ±3°C (ambient to 302°F ±5°F)

Needle (metal) heater 40°C (104°F), < 50 watts

Syringe heater. 60°C (140°F), < 50 watts

Motors

3 brushless, axis, servo/closed loop encoder

Valves/Tools

Mountable valves/drills/vacuum tools . . . Up to 2

Vision

ClearVu™ Vision Zoom 125C:

- Motorized module - remote and automatic operation
- Integral iris for better control of light level and increased depth-of-field
- Internal 15 mm (non coaxial versions) Fine Focus axial distance at the object

		AUXILLARY LENS 1.5X		0.5X TV TUBE		
		52 mm working distance		Low	High	
ZOOM 125C	Numerical Aperature		0.029	0.15		
	Magnification		0.39	4.9		
	Depth-of-Field		0.66	0.024		
	Field-of-View (mm) Camera Format	1/4"		6.9 x 9.3	0.56 x 0.75	
		1/3"		9.1 x 12.2	0.74 x 0.98	

Paint Color Codes

- White paint Imron 3.5 (43-CG1104)
- Conductive paint 599-Y2000

Connection Locations

Figure 32: MAX SERIES Air, power, and other connection facility information for all MAX Series models.

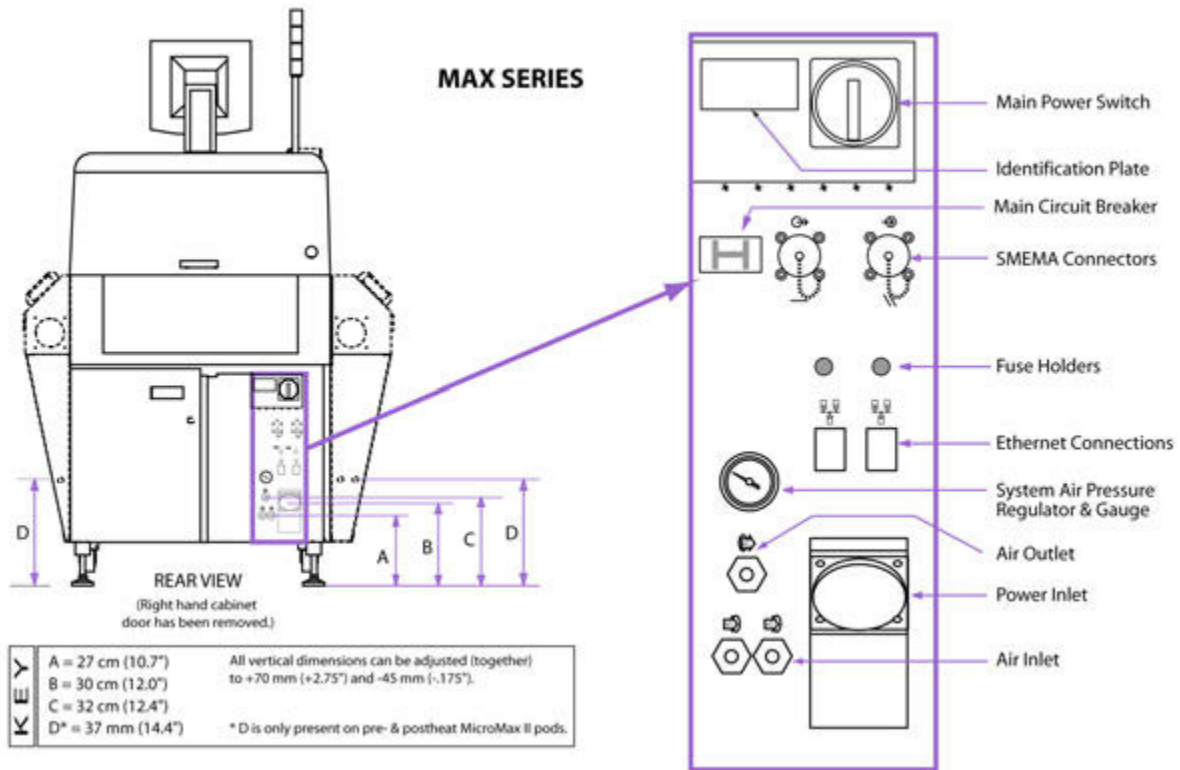

Spacing & Locations

Spacing and location of tie downs:

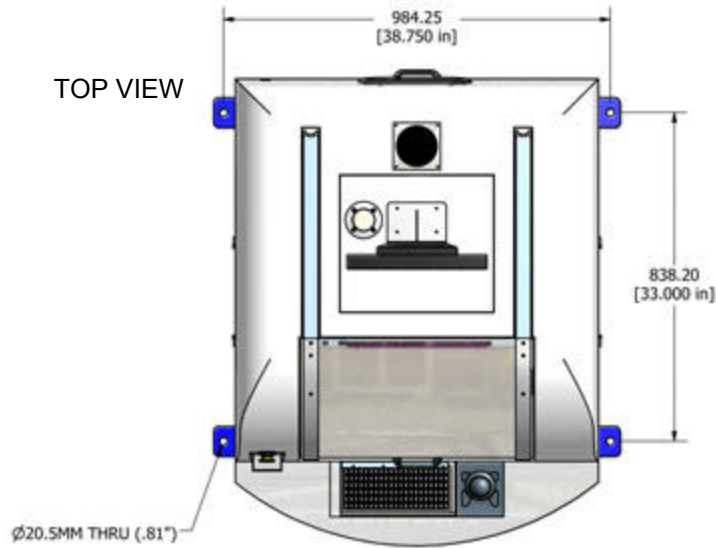

Instructions for installing the system with tie downs are detailed at [Tie Downs](#) (pg 2.3).

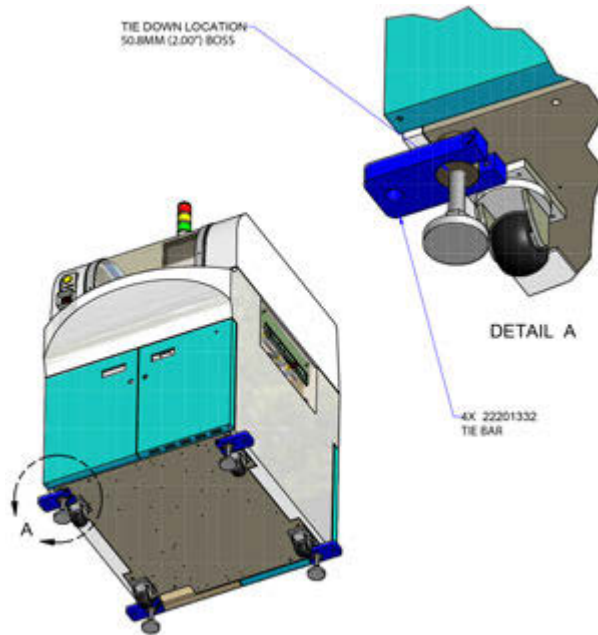

DS Series Specifications

Dimensions & Weight

Dispense Area (X x Y x height)

Table 43: Non-Heated Dispense Area by Model

Model	Mount Position 1 Dispense Area *	Mount Position 2 Dispense Area *	Mount Position 3 Dispense Area *
DS9000 DS9000 IL	46 x 46 x 7.6 cm (18" x 18" x 3")	42 x 46 x 7.6 cm (16.5" x 18" x 3")	37 x 46 x 7.6 cm (14.4" x 18" x 3")
DS9100 DS9100 IL	61 x 61 x 7.6 cm (24" x 24" x 3")	55 x 61 x 7.6 cm (21.7" x 24" x 3")	50 x 61 x 7.6 cm (19.6" x 24" x 3")

*Based on a single camera, single valve, and surface sensor.

Machine Footprint

Additional detail is available at [Dimension Details](#) (pg 7.14).

Table 44: Footprint Dimensions by Model - monitor travel included

Model	Dimensions (W ^A x D ^B x H)	Weight (approximate)
Stand Alone	DS9000	170 cm x 146 cm x 196 cm 67" x 57.5" x 77"
	DS9100	185 cm x 166 cm x 196 cm 73" x 65.5" x 77"
Inline	DS9000 IL	193 cm x 146 cm x 196 cm 76" x 57.5" x 77"
	DS9100 IL	220 cm x 166 cm x 196 cm 86.5" x 65.5" x 77"

^A Width includes a standard monitor on a swivel arm.

^B Depth includes monitor in swung-out position. Monitor size equates to dimension H [in [Dimension Details](#) (pg 7.14) drawing].

Crated Specifications

Table 45: Crate Specifications by Model

Model	Dimensions (WxDxH)	Crated Weight (approximate)
Stand Alone	DS9000	180 cm x 157 cm x 206 cm 71" x 62" x 81"
	DS9100	196 cm x 178 cm x 206 cm 77" x 70" x 81"
Inline	DS9000 IL	203 cm x 157 cm x 206 cm 80" x 62" x 81"
	DS9100 IL	231 cm x 178 cm x 206 cm 91" x 70" x 81"

Clearance Dimensions

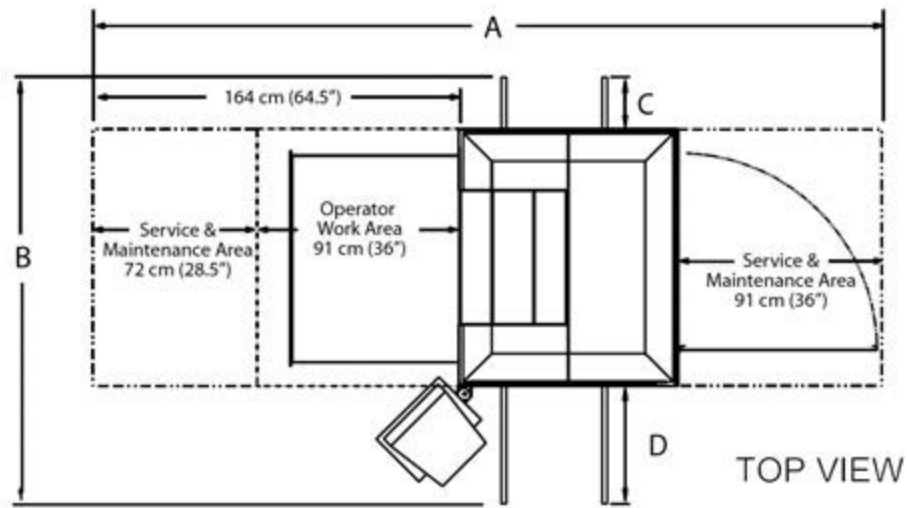

Table 46: Standard Model Dimensions

	DS9000 Models	DS9100 Models
A	354 cm (139.5")	375 cm (147.5")
B	218 cm (86")	244 cm (96")

Table 47: Conveyor Model Dimensions

	DS9000 Models	DS9100 Models
A	354 cm (139.5")	375 cm (147.5")
B	218 cm (86")	244 cm (96")
C	23 cm (9")	34 cm (13.5")
D	53 cm (21")	53 cm (21")

Dimension Details

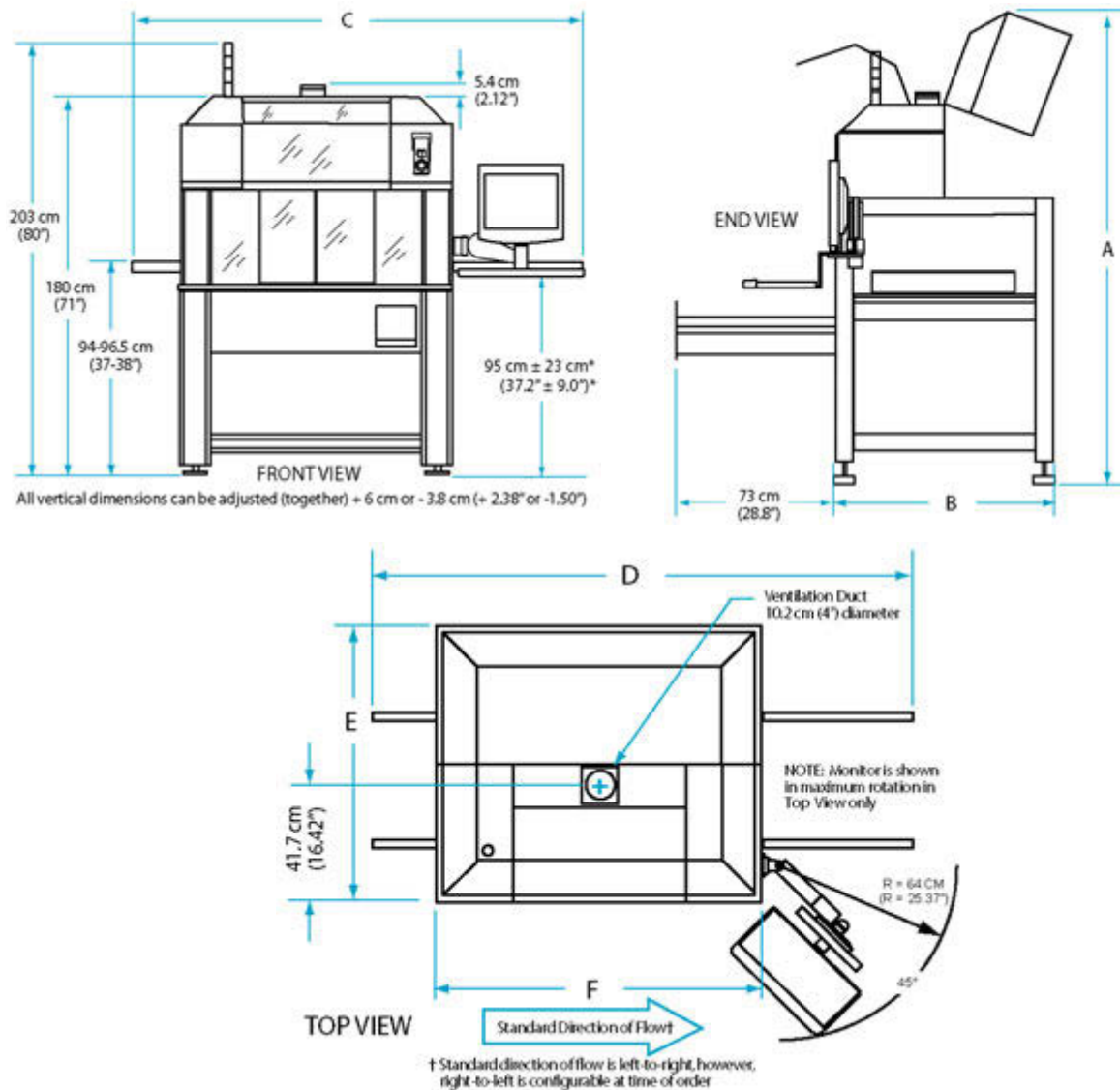

Table 48: Standard Model Dimensions

	DS9000 Models	DS9100 Models
A	224 cm (88")	231 cm (91")
B	99 cm (39")	119 cm (47")
C	218 cm (86")	244 cm (96")
D	193 cm (76")	220 cm (86.5")
E	99 cm (39")	119 cm (47")
F	117 cm (46")	132 cm (52")

All vertical dimensions can be adjusted (together)
+6 cm or -3.8 cm (+2.38" or -1.50")

Standard direction of flow is left-to-right, however, right-to-left is configurable at time of order.

Requirements

Power

Breaker/Fusing GPD Global recommends use of dedicated, external circuit breaker/fusing. Alternately, use properly rated branch fusing.
 Power requirements by model Refer to Table 49.

Table 49: Power Requirements by Model

Model	Volts AC*	AC Frequency	Phase	Amps @ Volts (maximum)
DS Series	120 Volts or 230 Volts‡	50/60 Hz	1Φ	10 amps @ 120 Volts or 5 amps @ 230 Volts
* ±10% ‡ 2-pole 3 wire ground NOTE1: To change input power, see System AC Input Voltage Change (pg 8.17). NOTE2: Hard wiring to machine is not possible.				

SEMI S2 ratings Refer to Table 50.

Table 50: SEMI S2 Ratings

<i>Largest Single Load Amp</i>	2 Amp non-heated Up to 10 Amp heated	<i>Operating Amp</i>	5 Amp non-heated Up to 15 Amp heated	<i>Branch Circuit Over Protection Required</i>	20 Amp
<i>Short Circuit Interrupt Capacity of the main over-current protective device</i>	10K (AIC) typical. Check serial number label for actual value.	<i>System KAIC</i>	5K (AIC)	<i>IP Rating</i>	IP20
<i>Minimum Protective Earth Ground conductor size</i>	#14 AWG	<i>Electrical Diagram Drawing Number</i>	00015-222-04-xx	<i>Over Current Protection Provided at Machine Terminals</i>	

Power cable Customer supplies connection hardware to bare end of cable (refer to Table 51) per customer's facility requirements/specifications for needed voltage.

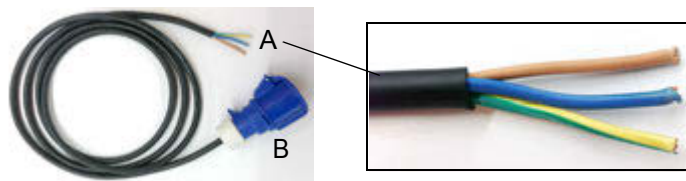

Table 51: Power Cable End Details

End	Description
A	brown, + *(line), 12 AWG (56/28) 4 mm ² blue, - (neutral), 12 AWG (56/28) 4 mm ² green/yellow, ground, 12 AWG (56/28) 4 mm ²
B	Power connector specific to GPD Global Dispense System

Air

Pressure (clean & dry air*)	552-621 kPa (80-90 psi)
Flow rate (maximum)	113 l/min @ 600 kPa (4 CFM @ 87 psi)
Machine	113 l/min @ 600 kPa (4 CFM @ 87 psi)
Nest vacuum	113 l/min @ 345 kPa (4 CFM @ 50 psi)
Air lines	GPD Global recommends you have a dedicated air line for each feature requiring air; although if flow rate is high enough, a branched air line may be sufficient. <i>Most systems require two air connections (machine + nest vacuum)</i>
Air fitting thread	1/4" NPT <i>Customer supplies connection hardware.</i>

Ventilation

Exhaust port* diameter	101,6 mm (4")
	<i>* customer supplies ducting to exhaust port</i>
Ventilation flow rate	7,079 l/min (250 CFM)

Environmental

Pollution rating	Category 2, Pollution degree 2
Degree of protection	IP 43
Operating Temperature	5°C to 40°C (41°F to 104°F)
Storage & transportation temperature	0°C to 60°C (32°F to 140°F)
Humidity (non-condensing)	< 50% @ 40°C (< 50% @ 104°F)
	<i>* maximum for operating</i>
Vibration (power supply)	To IEC 68-2.6 and BS2011 Part 2.1 Fc 1983.
EMI in compliance with	EN 61000-4-2, EN 50082-2, EN 61000-4-4, ENV 50140, ENV 50141, and EN 55011 class A

Performance

Dispense rate*	28,000 DPH
	<i>*based upon 1,27 mm (0.050") pitch, 1,000 dot matrix</i>
Accuracy**	±0.038 mm (±0.0015")
	<i>**with system mapping over standard work area</i>
Repeatability (per axis)	±0.0152 mm (±0.0006")
Acceleration	0.5G
Linear speed	.51 cm/sec (20 inches/sec)
Z axis travel	.76 cm (3")
Resolution (per axis)	±0.005 cm (±0.0002")

Capacities

Product

Product Thickness (min/max)Varies; based on width of product and its rigidity.

Product Clearance*

Above board±25,4 mm (±1.0")

Below board±25,4 mm (±1.0")

**Custom configurations are available for both above and below board clearance. Standard above board clearance is determined by on-axis illumination and distance between dispense tip and probe. Standard below board clearance is determined by optional contact fixture and the sensor distance below the board.*

Conveyor-specific Product:

Load Capacity**, generic maximum 2 kg (4.41 lbs)

Board Carrier

Length***

DS9000IL..... 75 mm to 483 mm (2.95" to 19.00")

DS9100IL..... 75 mm to 635 mm (2.95" to 25.00")

Width

DS9000 IL..... 38 mm to 457 mm (1.5" to 18")

DS9100 IL..... 38 mm to 610 mm (1.5" to 24")

***A combination of various factors affect the amount of weight the conveyor can pull: belt width, belt material, the number of board stops in use, etc. Custom configurations are available to accommodate heavier load capacity.*

****Can be increased for custom configurations or reduced by using various board stop options.*

Conveyor

ComplianceAll dispenser models are in compliance with [IPC SMEMA 9851](#) (pg 8.16)

Transport height (SMEMA specifications):

From floor to bottom of product. . .94 cm to 97 cm (37" to 38")

Parallelism of rail at lead screw:

From lead screw to lead screw . . . 0,38 mm (0.015")

From lead screw to any

unsupported point on conveyor. . . 1,52 mm (0.060")

Width Adjustment

DS9000IL 38,1 mm to 464 mm (1.50" to 18.25")

DS9100IL 38,1 mm to 616 mm (1.50" to 24.25")

Edge Clearance‡ 3 mm edge belt with tolerance > 5 mm per side
5 mm edge belt with tolerance > 7 mm per side

‡Custom edge belt clearance is available.

Heating

Work Area:

- Maximum heating(dispense area only) 3 kilowatt
- Plate temperatureambient to 200°C (ambient to 392°F)
- Lifter plate heater110°C ± 5°C (230°F ± 41°F), 1 kilowatt

Heater Types - maximum heating:

- Pre-heat (convection/hot air) 200°C ± 3°C (392°F ± 5°F), 1 kilowatt
- Pre-heat (non-contact/radiant) . . . 100°C ± 3°C (212°F ± 5°F), 1 kilowatt
- Post-heat (convection/hot air) . . . 200°C ± 3°C (392°F ± 5°F), 1 kilowatt
- Post-heat (non-contact/radiant) . . 100°C ± 3°C (212°F ± 5°F), 1 kilowatt
- Fixture heater200°C ± 3°C (392°F ± 5°F), 1 kilowatt
- Material heater100°C (212°F), < 50 Watts
- Needle (metal) heater100°C (212°F), < 50 Watts
- Syringe heater100°C (212°F), < 50 Watts

Valves/Tools

Mountable valves/drills/vacuum tools . . . Up to 3

Motors

3 axis servo/closed loop encoder

Vision

ClearVu™ Vision Zoom 125C:

- Motorized module - remote and automatic operation
- Integral iris for better control of light level and increased depth-of-field
- Internal 15 mm (non coaxial versions) Fine Focus axial distance at the object

		AUXILLARY LENS 1.5X		0.5X TV TUBE		
		52 mm working distance		Low	High	
ZOOM 125C	Numerical Aperture			0.029	0.15	
	Magnification			0.39	4.9	
	Depth-of-Field			0.66	0.024	
	Field-of-View (mm) Camera Format	1/4"			6.9 x 9.3	0.56 x 0.75
		1/3"			9.1 x 12.2	0.74 x 0.98

Paint Color Codes

White paint	Imron 3.5 (43-CG1104)
Conductive paint599-Y2000

Connection Locations

Figure 33: DS SERIES Air, power, and other connection facility information:

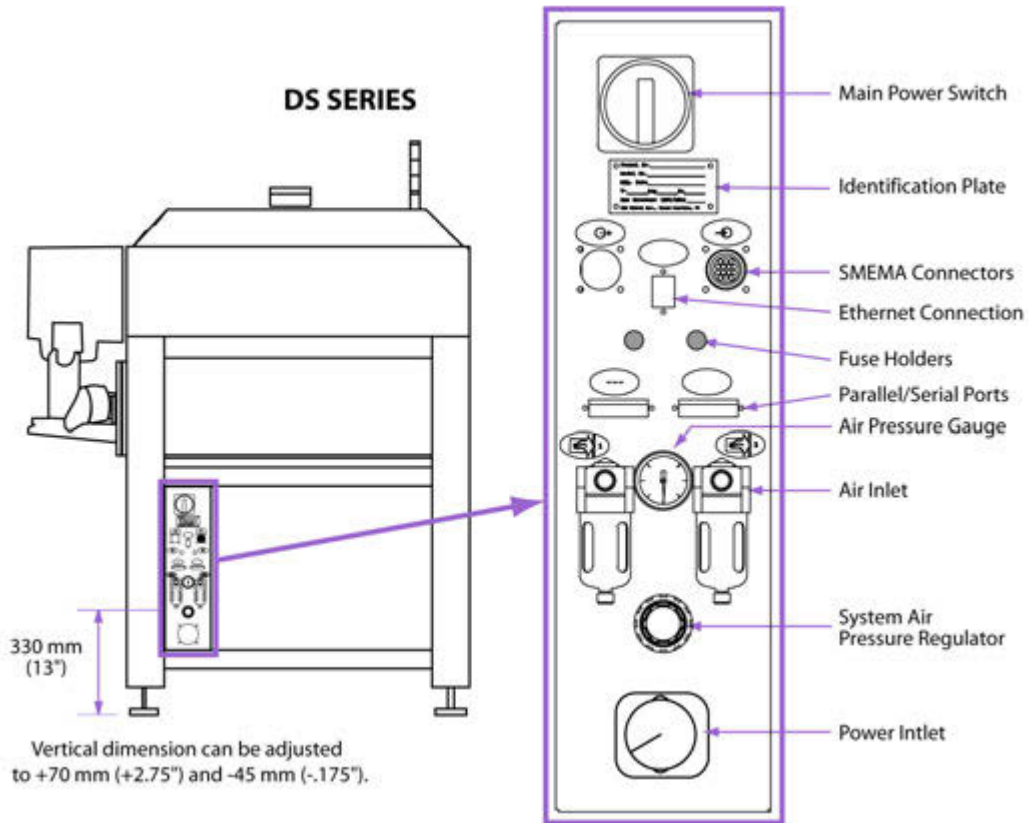

Weigh Scale

WMC24-SH Model

Weighing capacity	21 g (0.7408 oz)
Readability at the interface	0.1 mg
Reproducibility	0.08 mg
Linearity	0.2 mg
Overload protection - the following values must not be exceeded:	
Vertical Load	1 kg (static load)
Lateral Load	200 g (static load)
Torsion	0.3 Nm
Operating temperature range	10° to 30°C (50° to 86° F)
Power requirements	100-240 VAC +10% to -15%
Power consumption (average)	0.5 VA
Frequency	50/60 Hz
Net weight (approximately):	
Scale and Draft Shield	1.279 kg (2.82 lbs)
Controller and Power Supply	2.6 kg (5.74 lbs)

CP Model

Weighing capacity	64 g (2.2575 oz)
Readability at the interface	0.0001 mg
Reproducibility	≤ ±0.0001 mg
Linearity	≤ ±0.0002 mg
Operating temperature range	10° to 30°C (50° to 86° F)
Power requirements	230 V or 115 V +15% to -20%
Power consumption (average)	9-16 VA
Frequency	48-60 Hz
Net weight (approximately)	1.535 kg (3.3841 lbs)

8 Special Topics

This section is comprised of procedures and background information for topics that affect and support operations at the service level.

- [Computer](#)
 - [I/O Card Cage - Card Identification](#) (pg 8.2)
 - [Removable Computer Hard Drive](#) (pg 8.3)
 - [Serial Communications Board](#) (pg 8.4)

- [Controllers](#)
 - [Temperature Controller Error Messages](#) (pg 8.8)
 - [Vacuum Control](#) (pg 8.9)

- [Conveyor](#)
 - [Conveyor Sensors](#) (pg 8.10)
 - [SMEMA Specification](#) (pg 8.16)

- [Facilities](#)
 - [UPS Control](#) (pg 8.17)
 - [System AC Input Voltage Change](#) (pg 8.17)

Computer

I/O Card Cage - Card Identification

I/O (input/output) card identification in the I/O card cage:

CARD CAGE (top view)

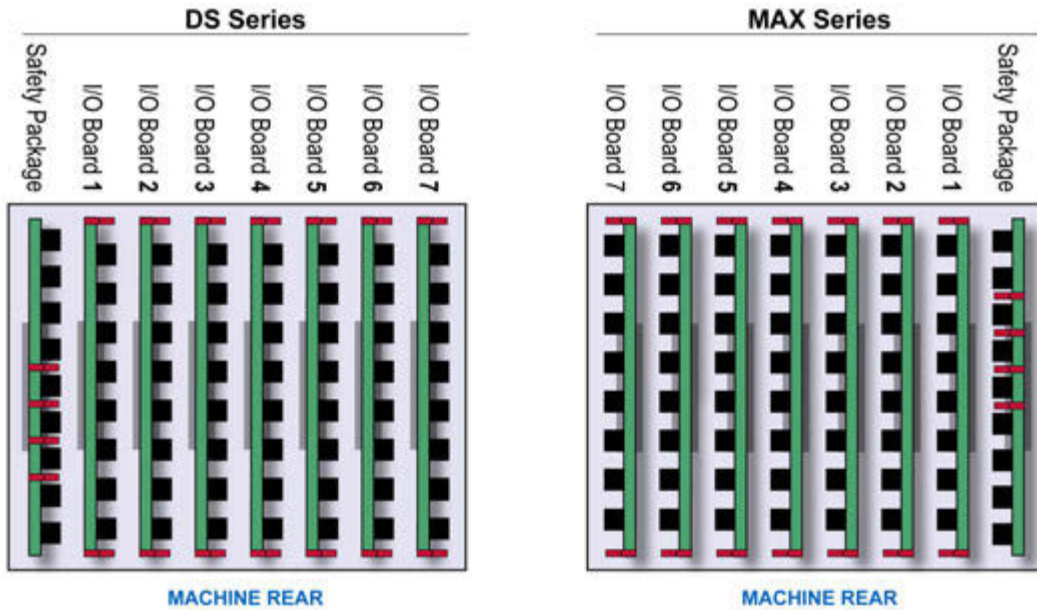

KEY

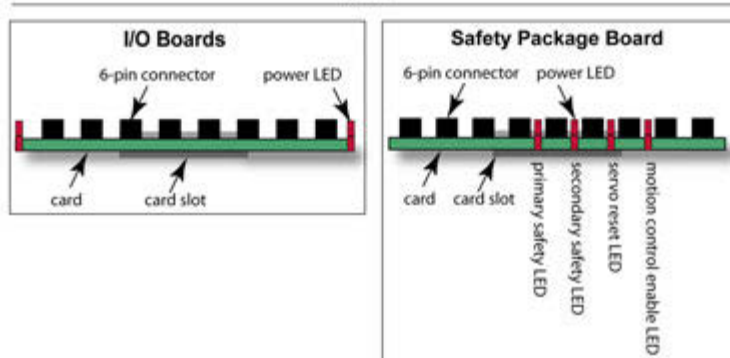

Removable Computer Hard Drive

Easily remove a hard drive from the dispenser to protect your valuable data, transport data between computers, and create online backup and storage of critical files.

To remove a removable hard drive from the dispense system:

1. Power off the dispense system.



CAUTION: DO NOT attempt to unlock the hard drive bay door until after the dispense system is powered off.

2. Unlock the hard drive bay door.
3. Pull bay door latch open and slide the hard drive out of bay slot.
4. As needed, slide a new hard drive into the bay slot.
5. Close and lock bay door.



CAUTION: DO NOT power on the dispense system until after the hard drive bay door is locked.

Legacy Computers

For systems with computers built prior to May 2018, follow the instructions below when turning on the system or removing the hard drive from the system.

Power On

The key lock or latch on the removable hard drive locks the cartridge in place and also serves as an ON/OFF switch for the power.

1. Turn the key lock or latch 90 degrees clockwise to the ON position before turning on the computer – the drive is preset to this position at the factory.
2. When the computer is turned on, the “Power On” LED (green light emitting diode below the key on the frame assembly) is illuminated, and the system should operate normally.

Removing Drive

If you need to remove the removable hard drive while the computer is running, observe the following precautions:

NOTE: Neither GPD Global nor the manufacturer of removable hard drive are liable for loss of data. It is the user’s responsibility to follow these important procedures to safeguard data.

1. Wait until the drive activity light has stopped; this indicates that no read/write activity is occurring.
2. If your system uses a disk caching program, ensure that all the data has been written to the hard drive.
3. Turn off the drive by turning the key to the OFF (vertical) position. The power LED goes off, indicating that the power has been cut.
4. Wait 10 to 15 seconds for the drive to park the drive heads, and then remove the cartridge with the drive in it.

Serial Communications Board

Whenever a serial device is added to the dispenser, a serial communications board also needs to be added to enable COM2, COM3, COM4, and COM5.

Installing 2-Port Blastronix Card

Required Equipment

- Blastronix 232/2S ISA (Part No. 2200-0321), quantity 1
- Cable applicable to the device to which this serial card will be connected

Figure 34: 2-port Blastronix card.

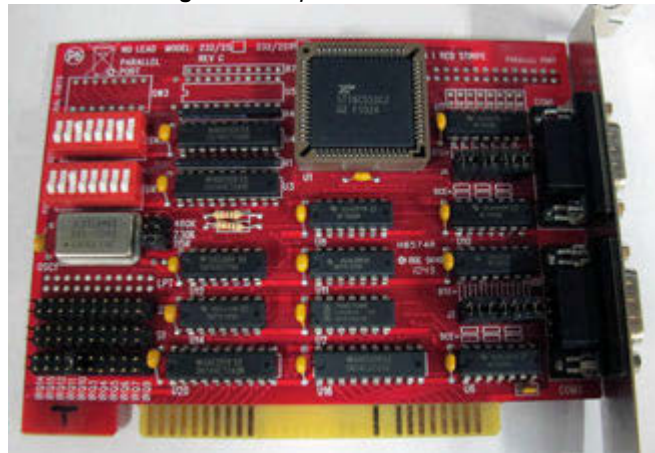

1. To install a 2-port Blastronix card in the dispenser computer, set the following switches/jumpers/connectors on the Blastronix card:

- a. Set the User Configurable settings:

Setting	Label	Position
Serial port 1 enabled	SW1/1	On
Serial port 2 enabled	SW2/1	On

- b. Set the Shared Interrupt selection:

Setting	S/A	S/B	S/C	S/D	S/E	S/F	S/G	S/H	S/I	S/J	S/K
10	Open	Open	Open	Open	Open	Open	Closed	Open	Open	Open	Open

- c. Set the Serial Port 1 Address selection:

Setting	SW1/2	SW1/3	SW1/4	SW1/5	SW1/6	SW1/7	SW1/8
3E8h (COM3:)	On	Off	On	On	On	On	On

- d. Set the Serial Port 2 Address selection:

Setting	SW2/2	SW2/3	SW2/4	SW2/5	SW2/6	SW2/7	SW2/8
2E8h (COM4:)	On	Off	On	On	On	Off	On

- e. Set the Serial Port Speed selection:

Setting	460K	230K	115K
115K	Open	Open	Closed

- f. Set the Serial Port 1 Configuration:

Setting	J2
DTE	Pins 1 & 2, 3 & 4, 5 & 6, 7 & 8, 9 & 10, 11 & 12, 13 & 14 closed

- g. Set the Serial Port 2 Configuration:

Setting	J4
DTE	Pins 1 & 2, 3 & 4, 5 & 6, 7 & 8, 9 & 10, 11 & 12, 13 & 14 closed

2. Install the Blastronix card in the dispenser computer:
 - a. Perform a system shutdown on the dispenser and turn it off.
 - b. Plug the card into an ISA slot.
 - c. Plug cable into the board and device.

3. Reserve IRQ 10 and leave COM1/2 active in the BIOS.

4. Edit **sysinit** and verify this line:

```
if [$ SERPORTS -eq 4]; then Dev.ser 3f8,4 2f8,3 3e8,10 2e8,10 &
```

5. Run **change.node.sh** in a shell and answer the prompts as follows:
 - a. Does this machine have 5 serial ports? **N**
 - b. Does this machine have 4 serial ports? **Y**
 - c. Does this machine have 3 serial ports? **N**
 - d. Does this machine have a modem on serial port 2? **N**
6. Reboot the system.
7. Configure and test the device to which you are connecting this serial card.

NOTE: COM1 is normally reserved for a serial mouse; COM2 cannot be used with a scale; and COM 3&4 have been tested with a scale and Optem Lens.

Installing 4-port DigiBoard

Required Equipment

- DigiBoard PC/X (Part No. 10/0270), quantity 1
- DB25 Octopus cable (Part No. 10/0274), quantity 1

To install a 4-port DigiBoard in the dispenser computer, set the following switches/jumpers/connectors on the DigiBoard card:

1. Orient the board so the plug side and DS1 - DS5 is the closest side to you and the cable connection plug is on the right side.

Figure 35: 8-port DigiBoard. (The 4-port board will not have switches DS6-DS8.)

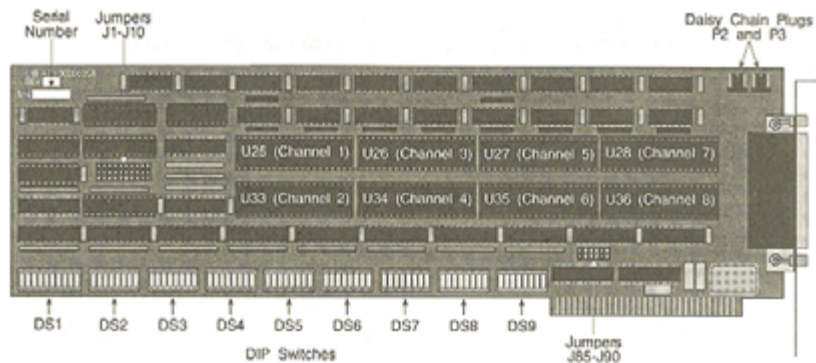

2. Set IO Address to 2f8 (DS1 switch) which is:

		SW1	SW2	SW3	SW4	SW5	SW6	SW7	SW8	SW9	SW10
DS1	2f8	OFF	ON	OFF	OFF	OFF	OFF	OFF	ON	ON	ON

3. Set DS2 through DS5 in the following manner:

		SW1	SW2	SW3	SW4	SW5	SW6	SW7	SW8
DS2	100	ON	OFF	ON	ON	ON	ON	ON	ON
DS3	108	ON	OFF	ON	ON	ON	ON	OFF	ON
DS4	110	ON	OFF	ON	ON	ON	OFF	ON	ON
DS5	118	ON	OFF	ON	ON	ON	OFF	OFF	ON

4. Set jumpers for only 1 (odd) interrupt IRQ3:
 - J85 jumper, J86 though J90 need no jumper

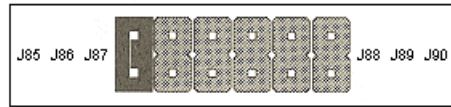

- J1 through J8 jumpers should be on the top two pins (J5 through J8 may or may not be present).
- J9 through J10 jumpers should be on the bottom two pins.

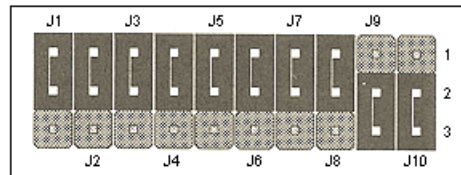

- P2 and P3 connectors should cover the middle two posts.

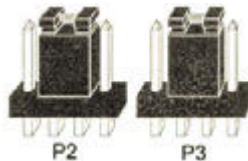

5. Install the DigiBoard in the dispenser computer:
 - a. Perform a system shutdown on the dispenser and turn it off.
 - b. Plug the DigiBoard into an ISA slot.
 - c. Plug the Octopus cable into the board and devices.
 - d. The scale is typically plugged into the P2 cable.
 - e. Be sure the cables are tight at all the connections.
6. Install device hardware, such as a scale. Refer to appropriate section.
7. To disable CPU COM2, enter the BIOS setup pertinent to your dispenser hardware. For details, refer to GPD Global procedure entitled CMOS Set Up.
8. Allow the system to boot.
9. Enter the appropriate password.
10. Enable 5 serial ports:
 - a. Click on System Functions > Shell.
 - b. Type `change.node.sh` and answer all the questions with the default values except answer Y to the question of 5 serial ports. After execution, the `/etc/config/sysinit` should contain the lines to enable 5 serial ports:

```
SERPORTS='5'
:
##          COM1   COM2   COM3   COM4   COM5   BIOS References
##          SER2   SER3   SER4   SER5   /dev (in dispenser)
##          P1     P2     P3     P4     DigiBoard octopus plugs
Dev.ser    3f8,4   100,3   108,3   110,3   118,3 &
```

11. Reboot the dispenser.

Controllers

Temperature Controller Error Messages

The following chart defines the error messages that may be displayed by the CAL 9900 temperature controller and what action is required for each message.

Press the UP and DOWN arrow buttons at the same time to reset latched message.

Table 52: Error Messages & Action Required

APPLICATION FAULTS			
EE1	Sensor burn out	Check sensor	Self clearing
EE2	RTD/PT100 short	Check sensor	Self clearing
EE3	LBA Loop break	Check control loop	Latches: Reset
AUTOTUNE AT/PT TUNING CYCLE FAULTS			
Autotune Run is Aborted: Previous Values are Retained			
EE5	Outside time limit	Latches: Reset	
EE6	O/shoot exceeds limit	Latches: Reset	
EE7	Unable to run Autotune, SP1 in ON/OFF mode	Latches: Reset	
SOFTWARE FAULTS			
EE8	Calibration data error	Replace unit if fault persists	
EE9	System error	Replace unit	

Vacuum Control

The comparative output set points for the vacuum detection sensor are typically preset at the factory. Set points may need to be changed if product and fixture vacuum requirements change.

When a vacuum set point is triggered, an input is sent to the system. For example, the software looks at the vacuum input prior to running a program and if vacuum is inadequate, an informative message displays.

Change Vacuum Set Points

To change one or both set points, follow these guidelines:

- P1 = minimum vacuum set point. P1 is typically set to a factory default of 50 kPa.
- P2 = maximum vacuum set point. P2 must be greater than P1 by at least 3.0 kPa (6.0 psi).

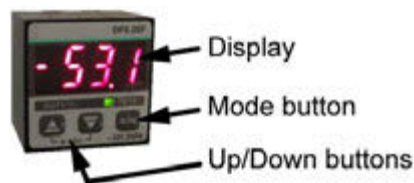

1. Press the MODE button. “P-1” and set value 1 display alternately.
2. If P1 set point needs to be changed, press the UP/DOWN buttons until desired setting displays; otherwise, skip this step.

If the UP or DOWN button is pressed continuously, the set value changes quickly. If the set pressure range is exceeded, either “UP” (upper limit exceeded) or “LO” (lower limit exceeded) displays.

3. Press MODE button. “P-2” and set value 2 display alternately.
4. To change P2 set point, press the UP/DOWN buttons until desired setting displays.

If the UP or DOWN button is pressed continuously, the set value changes quickly. If the set pressure range is exceeded, either “UP” (upper limit exceeded) or “LO” (lower limit exceeded) displays.

5. Press mode button.

Conveyor

Conveyor Sensors

The conveyor may use either of two types of conveyor sensors: either infrared or high temperature fiber optic. These amplifiers are typically mounted on either side of each conveyor stop bar. If a sensor is not sending a good signal, the sensitivity may need adjustment. Select the information applicable to the type of sensor your dispenser conveyor uses:

- [Fiber Optic Sensor \(PN 2475-0032\)](#) (pg 8.10)
- [Fiber Optic Sensor \(PN 2475-0022\)](#) (pg 8.12)
- [Infrared Sensor \(PN 3700-0052\)](#) (pg 8.14)

Fiber Optic Sensor (PN 2475-0032)

7 PART DESCRIPTION

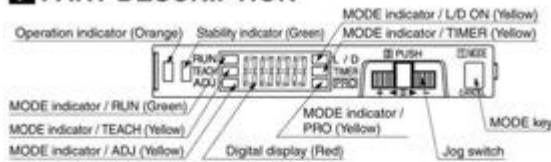

8 OPERATION PROCEDURE

- When the power supply is switched on, communication self-check is carried out and normal condition is displayed [MODE indicator / RUN (green)] lights up and the digital display shows the incident light intensity.

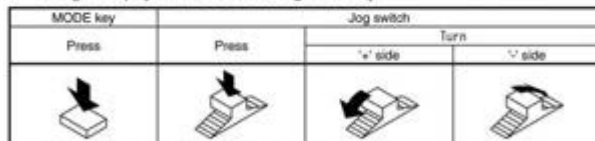

- *1: When Jog switch is pressed, the setting is confirmed.
- *2: When MODE key is pressed for 2 sec., or more, the sensor returns to the 'RUN' mode.
- *3: Cancellation is possible by pressing MODE key during setting.
- *4: When Jog switch is turned in the 'RUN' mode, the current threshold value is displayed. And then, the current incident light intensity display appears again automatically.

● NAVI mode

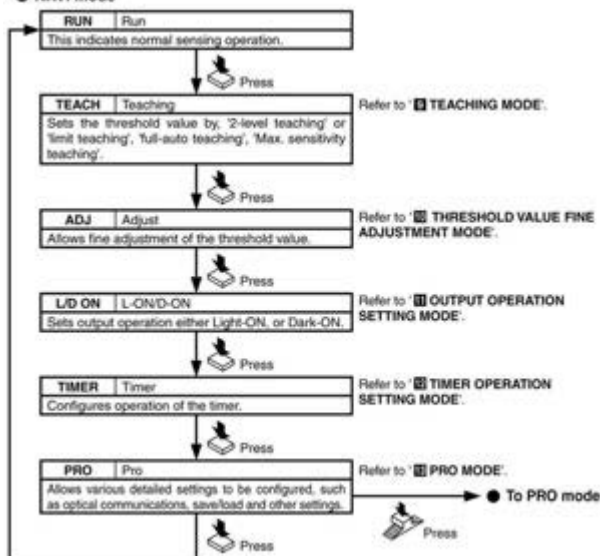

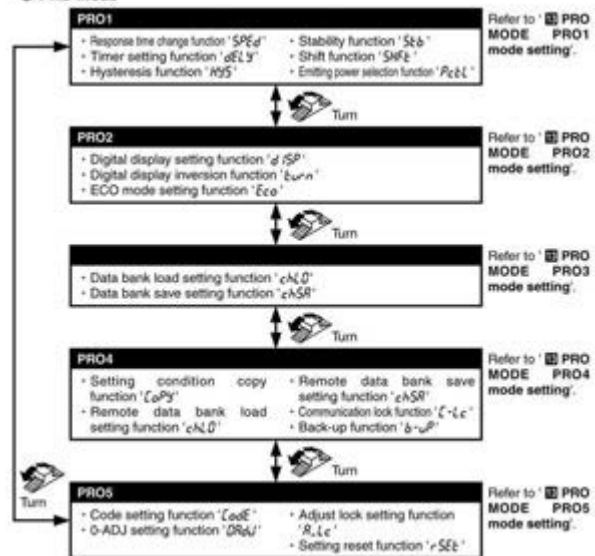

● PRO mode



9 TEACHING MODE

In case of 2-level teaching



● This is the method of setting the threshold value by teaching two levels, corresponding to the object present and object absent conditions. Normally, setting is done by this method.

Step	Display	Description
①	1234	<ul style="list-style-type: none"> Set the fiber within the sensing range. Press MODE key to light up MODE indicator / TEACH (yellow). 
②	567	<ul style="list-style-type: none"> Press Jog switch in the object present condition. If the teaching is accepted, the read incident light intensity blinks in the digital display. 
③	1234	<ul style="list-style-type: none"> The MODE indicator / TEACH (yellow) blinks. Press Jog switch in the object absent condition. 
④	9000 NR-d	<ul style="list-style-type: none"> If the teaching is accepted, the read incident light intensity blinks in the digital display and the threshold value is set at the mid-value between the incident light intensities in the object present and the object absent conditions. After this, the judgment on the stability of sensing is displayed. In case stable sensing is possible: '9000' is displayed. In case stable sensing is not possible: 'NR-d' is displayed.
⑤	9000	The threshold value is displayed.
⑥	1234	The incident light intensity appears in the digital display and the setting is complete.

Note: In case of using the fibers, if Jog switch is pressed in the object absent condition at ② and ③, the sensitivity is set to the maximum.

In case of limit teaching

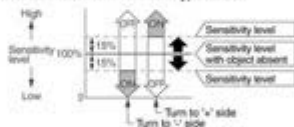

● This is the method of setting the threshold value by teaching only the object absent condition (stable incident light condition). This is used for detection in the presence of a background body or for detection of small objects.

Step	Display	Description
①	1234	<ul style="list-style-type: none"> Set the fiber within the sensing range. Press MODE key to light up MODE indicator / TEACH (yellow). 
②	1234	<ul style="list-style-type: none"> Press Jog switch in the object absent condition. If the teaching is accepted, the read incident light intensity blinks in the display. 
③	1234	<ul style="list-style-type: none"> The MODE indicator / TEACH (yellow) blinks. Turn Jog switch to the '+' side or the '-' side. 
④		<ul style="list-style-type: none"> If Jog switch is turned to the '+' side, ' ' scrolls (twice) the display from right to left, and the threshold level is shifted to a value approx. 15% higher (lower sensitivity) than that set at ②. Turn to '+' side (Note) This is used in case of reflective type fibers. If Jog switch is turned to the '-' side, ' ' scrolls (twice) the display from left to right, and the threshold level is shifted to a value approx. 15% lower (higher sensitivity) than that set at ②. Turn to '-' side (Note) This is used in case of thru-beam type fibers. 
⑤	9000 NR-d	<ul style="list-style-type: none"> After this, the judgment on whether the set shift amount is possible or not will be displayed. When the shift is possible: '9000' is displayed. When the is not possible: 'NR-d' is displayed.
⑥	1420	The threshold value is displayed.
⑦	1234	The incident light intensity appears in the digital display and the setting is complete.

Note: The approx. 15% amount of shift is the initial value. The amount of shift can be changed in the PRO mode from approx. 5 to 80% (5% step). Refer to 'PRO MODE / PRO1 mode setting' for the setting method.

In case of full-auto teaching

● Full-auto teaching is used when it is desired to set the threshold value without stopping the assembly line, with the object in the moving condition.

Step	Display	Description
①	1234	<ul style="list-style-type: none"> Set the fiber within the sensing range. Press MODE key to light up MODE indicator / TEACH (yellow). 
②	567	<ul style="list-style-type: none"> Press Jog switch continuously for 0.5 sec. or more with the object moving on the assembly line. (The incident light intensity is displayed during sampling.) 
③	Auto	'Auto' is displayed on the digital display. Release the jog switch when the object has passed.
④	9000 NR-d	<ul style="list-style-type: none"> If the teaching is accepted, the read incident light intensity blinks in the digital display and the threshold value is set at the mid-value between the incident light intensities in the object present and the object absent conditions. After this, the judgment on the stability of sensing is displayed. In case stable sensing is possible: '9000' is displayed. In case stable sensing is not possible: 'NR-d' is displayed.
⑤	9000	The threshold value is displayed.
⑥	1234	The incident light intensity appears in the digital display and the setting is complete.

Fiber Optic Sensor (PN 2475-0022)

Part Description

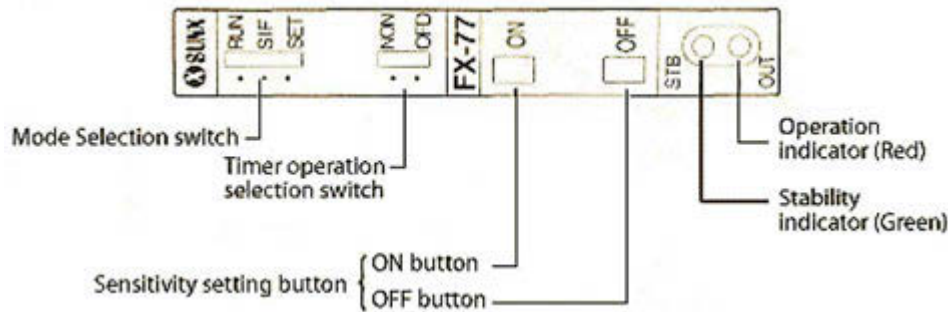

Sensitivity Setting

● Use of sensitivity setting buttons (Common for all models)

- Place the fiber cable within the sensing range. (Note 1)
- Set the mode selection switch to 'SET'

[For sensing output ON with object present]

- Press **ON button** with the object present.

Thru-beam type

Light interrupted condition

Reflective type

Mark

Base
- When ON state is recognized by the sensor, stability indicator (green) will flash.
- Press **OFF button** with the object absent.

Thru-beam type

Light is received condition

Reflective type

Mark

Base
- The stability indicator will **flash twice** if the sensitivity gap between ON state and OFF state is sufficient and a stable detection is possible. The stability indicator will flash continuously if stable detection is not possible. (Note 2)
- Set the mode selection switch to 'RUN'. The sensitivity setting buttons become ineffective. So, even if the buttons are pressed by mistake, the registered sensitivity will remain unchanged.

[For sensing output ON with object absent]

Press **ON button** with object absent.

Press **OFF button** with object present.

Notes:

- Refer to the catalog as the sensing range differs according to the type of fiber cable. The sensing range of the reflective type fiber cable is the value for white non-glossy paper. The actual sensing distance differs according to the color of the sensing object, its surface condition, etc.
- The sensitivity can also be set under unstable sensing condition. But the severe condition may affect the sensing.
- The set sensitivity is stored in an EEPROM. Since the EEPROM has a lifetime, the sensitivity setting cannot be done for more than 100,000 times.
- Do not move or bend the fiber cable after the sensitivity setting. Detection may become unstable.

How to set the maximum sensitivity

- Set the mode selection switch to 'SET'.
 - In case of Light-ON operation
In the dark condition, press the ON button and then the OFF button successively. (or, make the remote sensitivity setting ON input and then the OFF input Low successively.)
 - In case of Light-OFF operation
In the dark condition, press the OFF button and then the ON button successively. (or, make the remote sensitivity setting OFF input and then the ON input Low successively.)
- Set the mode selection switch to 'RUN'.







(Applications)

- For getting a long sensing range with reflective type sensor.
- For using thru-beam type sensor in an unfavorable sensing environment.

● **Interference prevention function (Incorporated in all models)**

- The FX-7 series has a built-in interference prevention function. Two fiber cables can be mounted very closely by setting different emission frequencies.

〈How to set〉

Step	Operation
1.	Set the mode selection switch to 'SET'. 
2.	Press 'ON' and 'OFF' buttons simultaneously for minimum two seconds continuously. The stability indicator (green) will blink. 
3.	Press 'ON' button. (The stability indicator will blink twice.) [Response time: 0.5ms or less (Note)] 
4.	Set the mode selection switch to 'RUN'. (This completes the setting for one sensor.) 
5.	Apply steps 1 and 2 for the second sensor.
6.	Press 'OFF' button. (The stability indicator will blink twice.) [Response time: 0.7ms or less (Note)] 
7.	Set the mode selection switch to 'RUN'. (This completes the setting.) 

〈How to cancel〉

Step	Operation
1.	Press 'ON' and 'OFF' buttons simultaneously for minimum two seconds continuously. The stability indicator (green) will blink. 
2.	Press 'ON' and 'OFF' buttons simultaneously again. (The stability indicator will flash twice.)

Note: When using the interference prevention function, the hysteresis and the response time increase as compared to that during normal operation. Always check the operation after setting the interference prevention function.

A mark can be put on the nameplate on the side of the sensor body for identification. Please use this, when required.

Button	Emitting frequency	Response time
ON	FREQ.1 BROWN, +V BLACK, OUT BLUE, 0V ORANGE, ALM PINK, R.ON VIOLET, R.OFF FREQ.1 ■ FREQ.2 □	0.5ms or less
OFF	FREQ.2 BROWN, +V BLACK, OUT BLUE, 0V ORANGE, ALM PINK, R.ON VIOLET, R.OFF FREQ.1 □ FREQ.2 ■	0.7ms or less

● **Sensitivity shift function (Incorporated in all models)**

- This is used for setting the maximum sensitivity for which the reflective type does not detect the background, or for sensing tiny objects with the thru-beam type.

〈Reflective type〉

1. Make normal sensitivity setting. (Refer to section 5 ADJUSTMENTS.)
2. Set the mode selection switch to 'SIF'. 
3. Press the sensitivity setting button again which was pressed with background.

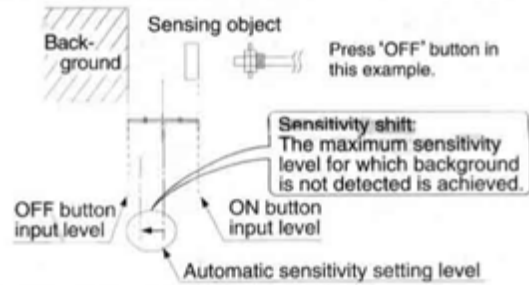



4. Set the mode selection switch to 'RUN'. 

〈Thru-beam type〉

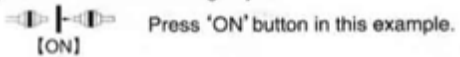

1. Make normal sensitivity setting. (Refer to section 5 ADJUSTMENTS.)
2. Set the mode selection switch to 'SIF'. 

3. Press the sensitivity setting button again which was pressed with the sensing object.



4. Set the mode selection switch to 'RUN'. 

〈Sensing of a tiny object with the thru-beam type〉

1. Set the mode selection switch to 'SET'. 
2. Press 'OFF' button (or ON button) without the sensing object.
3. Press 'ON' button (or OFF button) when light is completely interrupted.
4. Set the mode selection switch to 'SIF'. 
5. Press the button again which was pressed without the sensing object.
6. Set the mode selection switch to 'RUN'. 

- Notes: 1) If sensing is not possible, apply normal sensitivity setting method, or use one of the small diameter fiber cables.
2) For FX-77, FX-77G, the sensitivity shift cannot be made by using remote sensitivity setting input.

Infrared Sensor (PN 3700-0052)

6 PART DESCRIPTION

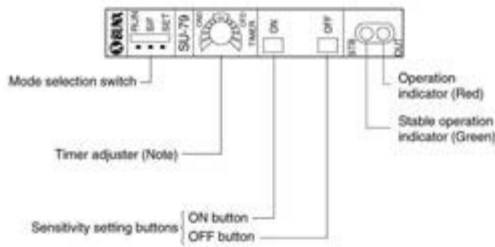

Note: It is the remote synchronization selection switch for SU-75.

7 SENSITIVITY SETTING

(Normally, set the sensitivity as per [Standard Setting].
If the sensing is unstable, set as per limit, shift or full power setting.)

[Standard setting]	<p>The operation level is set approximately halfway between the light intensity received for ON input and OFF input.</p>
[Limit setting]	The optimum sensitivity is set with one press of the button (or with one Low input). The sensitivity can be set without sensing a workpiece.
[Shift setting]	If the received light intensity fluctuates either in the workpiece present or absent state, shift the operation level towards the stable light intensity state.
[Full power setting]	The MAX. sensitivity is set. Note: In case of reflective type sensor, if a background is present, the sensor may become ON even without a workpiece.

[Standard Setting] (Automatic sensitivity setting function)

(In case the sensing output is ON when object is detected.)

Setting procedure

Step	Operation
①	Place sensor head within the sensing range. (Note1)
②	Set mode selection switch to "SET".
③	Press ON button with the sensing object present. (Release it within 3s.)
④	When ON state is recognized by the sensor, stable operation indicator (green) will flash.
⑤	Press OFF button with the sensing object absent. (Release it within 3s.)
⑥	The stable operation indicator will flash twice if the sensitivity difference (received light intensity difference) between ON state and OFF state is sufficient and a stable detection is possible. Stable operation indicator will flash continuously if stable detection is not possible. (Note 2)
⑦	Set mode selection switch to "RUN". Now, the sensitivity setting buttons are ineffective. So, even if the buttons are pressed by mistake, the registered sensitivity will remain unchanged.

(In case the sensing output is ON when object is not detected.)

In the above procedure

Press ON button with the sensing object absent.

Press OFF button with the sensing object present.

Notes: 1) As the sensing range will differ according to the type of sensor head, refer to the catalog. The sensing range for the reflective type sensor head is the figure for white non-glossy paper. The actual sensing range will differ according to the sensing object's color, surface condition, etc.

2) The sensitivity can be registered in the sensor even if the sensing condition is not stable.

- Setting by remote sensitivity setting input (For SU-77 only)
 - Instead of pressing buttons, the sensitivity can be set with the remote sensitivity setting input.
 - (Shift setting cannot be done with remote sensitivity setting input.)

Setting procedure

The procedure is the same as for setting with the sensitivity setting buttons, except that instead of pressing the buttons, the remote sensitivity setting input wire is short-circuited to 0V. The mode selection switch is set to either the "SET" or "RUN" side.

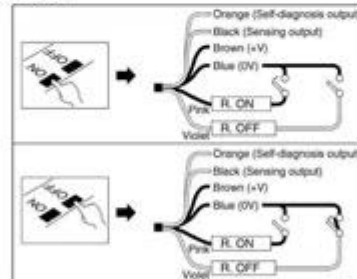

Time chart

The self-diagnosis output stays ON for approx. 40ms after ON input or OFF input is recognized by the sensor.

(If the difference between the ON and OFF levels (the difference between incident light levels) is so small that stable detection is not possible, it does not turn ON.)



T1 ≥ 1,000ms, 3,000ms > T2 ≥ 5ms, T3 ≈ 310ms, T4 ≈ 40ms, T5 ≥ 500ms

Notes: 1) Signal condition ... Low: 0 to 1V, High: 4.5 to 30V, or open
Input impedance: 10kΩ

2) Do not move the workpiece, etc., or change the received light intensity during T3.

[Limit Setting] (Limit setting function)



Setting procedure

Step	Operation
①	Set the sensor without an object and under stable light receiving condition.
②	Set mode selection switch to "SET".
③	By pressing either ON or OFF button for 3 sec. or more, the threshold level is set 15% either lower or higher than the object absent level as shown in the right figure. <p>(Please note that the output operation cannot be reversed.) For example, press the ON button for detecting a tiny object.</p>
④	Set mode selection switch to "RUN".

Time chart



T1 ≥ 1,000ms, T2 ≥ 3,000ms, T3 ≈ 310ms, T4 ≈ 40ms
 Notes: 1) Do not move the workpiece, etc., or change the incident light intensity during T3.
 2) Setting cannot be done if the light received is too strong or too weak.

[Shift Setting] (Sensitivity shift function)

In case of using thru-beam type sensor heads in a dusty environment

The optical beam can be interrupted without a sensing object if there is dirt or dust on the sensor heads. Sensing will be more reliable against dirt or dust if the sensitivity is shifted towards the stable (sensing object sensed) side.

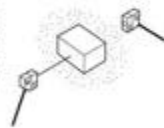

Setting procedure

Step	Operation
①	Set the sensitivity by following the standard setting procedure. (If the sensitivity margin is small, sensitivity shift cannot be done.)
②	Set mode selection switch to "SIF".
③	Press the sensitivity setting button which was pressed in the stable light received condition. For example, for a thru-beam type sensor, if there is dirt or dust, press the button which was pressed with the sensing object being sensed.
④	Set mode selection switch to "RUN".

[Full Power Setting]

Setting procedure

Step	Operation
①	Make sure that the sensor receives no light.
②	Set mode selection switch to "SET".
③	Press the "ON" button in the Light-ON mode. Press the "OFF" button in the Dark-ON mode.
④	When the input is recognized by the sensor, the stability indicator (green) blinks.
⑤	Press the "OFF" button in the Light-ON mode. Press the "ON" button in the Dark-ON mode.
⑥	When the input is recognized by the sensor, the stability indicator (green) blinks.
⑦	Set mode selection switch to "RUN".

STABILITY MARGIN INDICATING FUNCTION (All models)

- After setting the sensitivity, the margin of the set value can be visually confirmed. The stability margin can be confirmed by the number of times that the stable operation indicator (green) flashes when mode selection switch is slid to "SIF" or "RUN" from "SET".

No. of flashes	0	1	2	3	4	5
Relation with stable operation indicator	OFF	OFF	OFF	ON	ON	ON
Margin	Low	Low	Low	High	High	High

Normally, the margin should be set as large as possible.

(How to increase the margin: Shorten the sensing range, use an optimum sensor head, etc.)

SMEMA Specification

IPC SMEMA 9851

All GPD Global dispenser models are in compliance with the IPC SMEMA 9851 Mechanical Equipment Interface Standard specification per SMEMA Interface Standard 1.2.

Related diagnostic information is provided in the I/O List and schematic(s) provided with your machine documentation.

Facilities

UPS Control

The optional UPS (uninterrupted power supply) battery backup feature provides full load power to the dispenser for a period of time allowing the dispenser to finish the part currently in process. For details about the UPS, refer to *UPS User Guide* (PN 22100145M).

System AC Input Voltage Change

In the event the user needs to change the AC voltage, both a fuse change and a physical line change on the transformer are required.



CAUTION Only qualified maintenance or electrical personnel fully aware of all safety precautions should perform this procedure.

ATTENTION:

Seules des personnes qualifiées, chargées de l'entretien ou de l'électricité et connaissant parfaitement toutes les consignes de sécurité, doivent effectuer cette procédure.

VORSICHT!

Dieser Arbeitsschritt darf nur von qualifiziertem Fachpersonal oder ausgebildeten Elektrikern ausgeführt werden, die mit allen Sicherheitsvorkehrungen vertraut sind.

ATTENZIONE

Soltanto personale qualificato per la manutenzione o elettricisti a conoscenza delle procedure di sicurezza devono eseguire questa procedura.

PRECAUCIÓN

Este procedimiento sólo debe ser realizado por personal de mantenimiento o electricistas cualificados que conozcan las medidas de seguridad.

Table 53: Voltage Change Guide

SERIES	115 V INPUT CONNECTION	230 V INPUT CONNECTION
MAX SERIES	<p>To change the machine's input voltage from 230 V to 115 V input:</p> <ol style="list-style-type: none"> Power off and disconnect machine power. For the following steps, refer to Terminal Strip 2 on the Power Control electrical schematic. Make the following changes at the primary terminal strip: <ol style="list-style-type: none"> Remove the jumper between the upper 0 and the lower 115. Add a jumper between the upper 115 and the lower 115. Add a jumper between the upper 0 and the lower 0. <p>NOTE: F1 and F2 must be 5 amp, 250 V, time-lag fuses. To change the machine's input voltage from</p>	<p>115 V to 230 V input:</p> <ol style="list-style-type: none"> Power off and disconnect machine power. For the following steps, refer to Terminal Strip 2 on the Power Control electrical schematic. Make the following changes at the primary terminal strip: <ol style="list-style-type: none"> Remove the jumper between the upper 115 and the lower 115. Remove the jumper between the upper 0 and the lower 0. Add a jumper between the upper 115 and the lower 0. <p>NOTE: F1 and F2 must be 5 amp, 250 V, time-lag fuses.</p>
DS SERIES	<p>To change the machine's input voltage from 230 V to 115 V input:</p> <ol style="list-style-type: none"> Power off and disconnect machine power. For the following steps, refer to Terminal Strip 2 on the Base Plate electrical schematic. Make the following terminal strip changes: <ol style="list-style-type: none"> Remove jumper from terminals 4 and 5. Jumper terminals 2 and 5. Jumper terminals 4 and 7. <p>NOTE: F1 and F2 must be 15 amp, 250 V, time-lag fuses.</p>	<p>To change the machine's input voltage from 115 V to 230 V input:</p> <ol style="list-style-type: none"> Power off and disconnect machine power. For the following steps, refer to Terminal Strip 2 on the Base Plate electrical schematic. Make the following terminal strip changes: <ol style="list-style-type: none"> Remove jumper from terminals 2 and 5, and terminals 4 and 7. Jumper terminals 4 and 5. <p>NOTE: F1 and F2 must be MDL-8, 250 V, time-lag fuses.</p>

9 References

Legacy Controls & Operations

This section includes all content related to the legacy Emergency Stop and Power Off controls previously located on the front control panel of the dispense system.

Which Control Panel Does My System Use?

Use this chart to determine which version of controls your system uses:

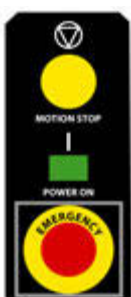
Which front panel is on your system?	 <p>CURRENT</p>	<p>This is the current version. It uses these controls:</p> <ul style="list-style-type: none"> • Emergency Stop • Power On • Power Off <p>Ignore this <i>Legacy Controls & Operations</i> section.</p>
	 <p>LEGACY</p>	<p>This is the legacy version. It uses these controls:</p> <ul style="list-style-type: none"> • Motion Stop • Power On • Emergency Stop <p>Use this <i>Legacy Controls & Operations</i> section when directed here at pertinent points in this document.</p>

As of June 2017, these hardware and terminology changes went into effect:

- *Emergency Stop was replaced with Power Off.*
- *Motion Stop was replaced with Emergency Stop.*

Legacy Contents

- [Power On](#) (pg 9.2)
- [Power Off](#) (pg 9.3)

Power On

To power on the dispenser:

1. Read all [Safety Notices](#) and operating instructions before operating the machine, and observe the following safety notices at all times when the system is powered on.

Safety Package Circuit Description - The safety package uses interlock switches, positive guided relays, servo control relays, and a safety gate monitor. Use the table below for quantity of each item by dispenser model. For diagram details, refer to the Safety Package Circuit Diagrams in the *Mechanical & Electrical Reference* document.

Table 54: Quantities Used in Safety Package

Item	MAX Series	DS Series
Interlock switches	2	2
Positive guided relay for removal of power to motors	3	1
Additional relays for control of servo enable signals and reset	3	3
Safety gate monitor	1	1



CAUTION DO NOT override the safety package or else personal injury could result.

ATTENTION NE PAS neutraliser les dispositifs de sécurité pour éviter des blessures corporelles.

VORSICHT! Setzen Sie NIEMALS die Sicherheitseinrichtungen ausser Kraft, es koennte Personenschaden entstehen.

ATTENZIONE NON aggirate le disposizioni sulla sicurezza, potrebbero verificarsi danni alle persone.

PRECAUCIÓN NO saltarse el paquete de Seguridad, o alguna persona podría sufrir daños.



CAUTION DO NOT open the safety shielding while a program is running or a safety violation message will appear and the program will abort.

ATTENTION NE PAS ouvrir l'écran de protection quand un programme est en cours d'exécution, sinon un message de violation de la sécurité apparaîtra et le programme sera interrompu.

VORSICHT! Bei laufendem Programm dürfen Sie die Schutzabdeckung NICHT öffnen. Andernfalls wird ein Sicherheitsverstoß gemeldet und das Programm abgebrochen.

ATTENZIONE NON aprire la protezione di sicurezza durante l'esecuzione di un programma altrimenti apparirà un messaggio di violazione di sicurezza ed il programma verrà interrotto.

PRECAUCIÓN NO ABRA la protección de seguridad mientras se esté ejecutando un programa, si lo hace aparecerá un mensaje de violación de seguridad y se abortará el programa.

2. In the event the user needs to change the AC voltage, refer to [System AC Input Voltage Change](#) (pg 8.17) for details.
3. Verify that the red Emergency Stop button is pulled out. If your machine is not equipped with this control, refer to *Emergency Stop* in the *Dispense System User Guide*.
4. Press the green Power On switch.

The system will automatically home the XYZ gantry when you turn on the power. The system must complete the homing sequence before other operations are possible. Continue with the following [Homing the System](#) (pg 3.3) instructions.

Power Off

Before powering off the machine, you must end any active program and perform the proper shutdown procedure.

Prepare for Shutdown

Before you can perform the shutdown procedure, you must end any active program. It is also recommended that you unload all product from the dispense area and remove and clean the heads.

To prepare for shutdown:

1. Stop program execution with one of these methods:
 - If the Mount Board prompt is displayed, click ABORT, or
 - Click CANCEL on the main button bar.
2. After the program has ended, remove all product from the dispense area. For details, refer to *Unload Product* in the *Dispense System User Guide*.
3. Unload all heads (valves and tools):
 - a. Click REFRESH on the main button bar to move the gantry to the front of the machine where you can access the heads.
 - b. Remove the heads. For details, refer to *Mount Heads* in the *Dispense System User Guide*.
 - c. Clean the heads. For details, refer to head cleaning instructions under [Cleaning Pumps](#) (pg 5.71).
4. Continue with the following [Shutdown](#) (pg 9.3) instructions.

Shutdown

The machine can be left powered on as long as the safety system has not been bypassed, however, GPD Global recommends that you power off equipment when it is not in use.

To shutdown and power off the machine:

1. Perform the preceding [Prepare for Shutdown](#) (pg 9.3) procedure.
2. From the main menu bar, click on Operations > Shutdown System. A shutdown verification prompt displays.
3. Click YES to shutdown the system or CANCEL to abort the shutdown. Wait until a System Stopped prompt displays.
4. Power off the machine by pressing the red Emergency Stop button.
5. Perform [Lock-Out](#) (pg 9.4) procedure.

Energy Isolation Procedures

Lock-Out



To ensure energy isolation, lock-out the equipment:

1. Turn off customer-supplied Lock-Out switch.
2. Turn off main power switch.
3. Install a lock or tag per your facility energy isolation procedures.
4. Test if system will start by pressing the Power On switch.
5. Test volt meter on known voltage source:
 - Test for presence of electrical power at TB1 and TB2 or at EMI Filter inlet L1 or L2.
 - Reconfirm volt meter on known voltage source.

Release Equipment from Lock-Out



To release equipment from customer-supplied Lock-Out switch:

1. Remove all tools, parts, and materials from the system.
2. Verify any and all work to ensure proper installation, polarity, connection.
3. Close all doors, covers, and shields.
4. Using facility-specific procedures, remove customer-supplied locks and/or tags.
5. Pull out the Emergency Stop button.
6. Ensure the power cord is connected.
7. Turn on main power switch, watching for electrical or other failure.
8. Follow the [Power On](#) (pg 9.2) procedure.

Index

A

- access, user controls 5.110
- accuracy 7.7, 7.16
- adjustment procedures 5.2–5.45
- air
 - Cylinder Seal, replace 5.80
 - pressure, pump 5.37
 - Requirements 7.7, 7.16
- alarm
 - Set Up 5.90
 - systems 6.2
- alignment, see adjustment procedures
- Auger Valve, see Valves
- Auto Clean 5.66

B

- Ball Lock Mount 4.9, 4.11
- Barcode Scan Program, testing 5.111

C

- CAL 9900, see Temperature Controller
- Calibration
 - Contour Mapping Kit 4.12
 - procedures 5.46–5.57
- Calibration Station
 - cleaning 5.58
 - Focus Tool 5.17
 - Height 5.2
 - Leveling surface 5.2
 - Light Intensity 5.4
 - Touch Pad 5.69
- Camera
 - adjust settings 5.22
 - alignment 5.5–5.21
 - ClearVu Vision Focus Tool Kit 5.6
 - ClearVU Vision specifications 7.9, 7.18
 - focus 5.8
 - Lamp Diffuser 5.60
 - Lens, cleaning 5.60
 - Lights, Multi-Axis 5.61
 - perpendicularity 5.15
 - replace 5.82
- Capacities 7.8, 7.17
- card cage, see I/O 8.2
- Clamp Mount 4.10, 4.11
- cleaning
 - Auto Clean 5.66
 - procedures 5.58–5.75
- clearance dimensions 7.5, 7.13

- computer
 - also see I/O 8.2
 - Hard Drive Setup 5.94
 - Removable Hard Drive 5.85, 8.3
 - Serial Communications Board 8.4
- connection locations 7.10, 7.19
- Contact Surface Sensor, testing 5.111
- Contour Mapping Calibration Kit 4.12
- controller, see Temperature Controller
- controls
 - Legacy Controls & Operations 9.1
 - user access 5.110
- Conveyor
 - belt tension 5.23
 - belt, replace 5.86
 - height 5.26
 - sensor sensitivity 5.24
 - sensors 8.10
 - Set Up 5.92
 - specifications 7.8, 7.17
 - speeds 5.25, 5.46
 - support 5.26
 - troubleshooting 6.6
 - width adjust 5.30–5.32
 - width calibration 5.50

D

- Dial Indicator 4.9, 5.5
- DigiBoard installation 8.6
- Dimensions
 - clearance 7.5, 7.13
 - details, DS Series 7.14
 - details, MAX II Series 7.4
 - details, MAX Series 7.3
 - DS Series 7.12
 - MAX Series & MAX II Series 7.2
- Dispense Area
 - DS Series 7.12
 - MAX Series & MAX II Series 7.2
- Documents, related 1.2

E

- Environmental requirements 7.7, 7.16
- error messages
 - system 6.2
 - temperature controller 8.8

F

- facility

- AC input voltage change 8.17
- connection data 7.10, 7.19
- UPS control 8.17
- Fan Failure 5.91
- Filter, cleaning 5.62
- focus tool 5.6, 5.17, 5.18, 5.20
- Footprint
 - DS Series 7.12
 - MAX II Series 7.2
 - MAX Series 7.2
- Fuses, replace 5.87

G

grease, *see* lubrication

H

- Hard Drive
 - Removable 5.85
 - Setup 5.94
- Head
 - Calibration Tool 4.10
 - mount positions, illustrated 4.10
- Heating specifications 7.8, 7.18
- Homing
 - procedure 3.3
 - sequence of gantry moves 3.3

I

- I/O
 - card cage, card ID 8.2
 - Viewer 4.12
- indicator, dial 4.9
- input/output, *see* I/O
- Installation
 - instructions 2.1
 - unpack & inspect 2.2
- IPC SMEMA 9851 8.16

K

- kit
 - cleaning 5.71
 - ClearVU Vision Focus Tool 5.6
 - Contour Mapping Calibration 4.12
 - Dispensers & Related Equip 1.2
 - Setup & Leveling 4.9, 5.5
 - spare parts 4.8

L

- Lens, *see* Camera
- Level
 - calibration station 5.2
 - machine, procedure 2.3

- scale surface 5.34
- Lifter Plate 5.26
 - Parallel to Gantry Travel 5.38
 - Upstroke Height 5.38
- light
 - calibration station 5.4
 - camera 5.61
 - tower, visual alarm 5.91
- Liquid Dispense Valve 5.88
- lubrication, procedures 5.76–5.77

M

- Maintenance
 - IO Viewer 4.12
 - periodic operations 5.1
 - Routine 4.1
 - Schedules 4.2
- Manuals, related 1.2
- mapping
 - Barcode Scan Program 5.111
 - Contour Calibration Kit 4.12
- Material Levels, program 5.66
- messages, troubleshooting 6.2
- Micro-Dot Valve, *see* Valves
- mount
 - see also* Head Mount Positions
 - ball lock 4.9, 4.11
 - clamp 4.10, 4.11
 - taper-lock 4.9, 4.11

N

- Needle
 - clean offline 5.65
 - clean online 5.66
 - Cleaning 5.63
 - Standoff calibration 5.51
 - Standoff Distance 5.33
 - Valve, *see* Valves
- Needle Cleaner
 - Activating 5.95
 - Auto Clean 5.66
 - cleaning 5.64
 - Focus Tool 5.18
 - Setup 5.95
 - turn on/off 5.66
 - using online/offline 5.96

P

- Paper
 - feed, calibration station 5.58
 - roll, changing 5.59
- PCD Pump, *see* Valves
- Pick & Place Tool 5.54

Pinch Tube Valve, *see* Valves

Power

- Off 3.4, 9.3
- On 3.1, 9.2
- On switch 3.2, 9.2
- On, removable hard drive 8.3
- requirements 7.6, 7.15

Procedure

- adjustments 5.2
- calibrations 5.46
- cleaning 5.58
- DigiBoard installation 8.6
- homing system 3.3
- installation 2.2
- lubrications 5.76
- mount valve in ball lock 4.11
- mount valve in clamp mount 4.11
- mount valve in Taper-Lock 4.11
- periodic operations 5.1
- power off 3.4
- power on 3.1
- purging 5.78
- removable hard drive power on 8.3
- removable hard drive, removing 8.3
- replacements 5.80
- setup 5.90–5.110
- shutdown 3.4, 9.3
- testing 5.111
- vacuum set points 8.9
- voltage change input 8.17

Purge

- Accounting Data 5.78
- compound, using 5.71
- procedures 5.78
- Valves Online 5.78

R

- recover software 6.3
- replacement procedures 5.80–5.89
- Requirements
 - DS Series 7.15
 - MAX Series & MAX II Series 7.6
- restore software 6.3
- Rigid Needle Standoffs 5.33, 5.51

S

Safety

- indicator systems 6.2
- Interlocks 5.89, 5.112
- maintenance 4.1, 6.1
- Notices 0.v
- Package Circuit Description 3.1, 9.2
- shield switches 4.6

Scale

- adjust/calibrate 5.55
- calibrate 5.55
- cleaning 5.67
- leveling surface 5.34
- parameters 5.34
- set up 5.97
- settings 5.34
- troubleshooting 6.8

SEMI S2 ratings 7.6, 7.15

Sensor

- contact surface 5.111
- conveyor 5.24, 8.10
- fiber optic 8.10, 8.12
- infrared 8.14

Serial Communications Board 8.4

Service panel, illustrated 2.5, 7.10, 7.19

set point

- heat 5.35
- vacuum 8.9

Setup

- & Leveling Kit 4.9
- Level 4.10
- procedures 5.90–5.110

Shields, Safety 5.89

Shutdown 3.4, 9.3

SMEMA

IPC SMEMA 9851 spec 8.16

software recovery 6.3

Spare Parts

- Kits 4.8
- KITS for Dispensers & Related Equip 1.2
- Touch Probe 5.70

Specifications 7.1–7.19

- crated dimensions & weight 7.2, 7.12
- DS Series 7.12–7.19
- heating 7.8, 7.18
- MAX Series & MAX II Series ??–7.11
- Requirements 7.6, 7.15

Speed

- Calibrate Conveyor 5.46
- conveyor 5.25
- performance 7.7, 7.16

Spool Valve, *see* Valves

standoff, *see* Needle

T

Taper-Lock Mount 4.9, 4.11

Temperature Controller

- adjust, CAL9900 5.35
- adjust, Watlow 5.35
- error messages, CAL9900 8.8
- recover settings, Watlow 5.107

- setup, CAL9900 5.108
 - setup, Watlow 5.107
- tension, conveyor belt 5.23
- Testing
 - procedures 5.111–5.113
- Tie Down 2.3
 - spacing & tie down locations 7.11
- Tooling Plate, adjusting 5.43
- Tools
 - Dial Indicator 4.9
 - Head Calibration 4.10
 - Pick & Place, calibrating 5.54
 - Setup Level 4.10
 - troubleshooting 6.9
- Touch Pad
 - cleaning 5.69
 - testing 5.113
- Touch Probe
 - cleaning 5.70
 - demagnetize 5.70
- Troubleshooting 6.1–6.9
 - alarms 6.2
 - IO Viewer 4.12
 - messages 6.2
 - symptoms/solutions 6.2

U

- UPS control 8.17
- user controls access 5.110

V

- vacuum control 8.9
- Valve
 - see alsoHead Mount Positions
 - air pressure, adjusting 5.37
 - Auger 5.71
 - cleaning 5.71–5.75
 - Cleaning Guide 5.71
 - Liquid Dispense 5.88
 - Micro-Dot 5.71, 6.9
 - Needle 5.71
 - PCD Pump 5.71, 6.9
 - Pinch Tube 5.71
 - Purge Online 5.78
 - Spool 5.71
 - troubleshooting 6.9
- Ventilation, requirements 7.7, 7.16
- Vision specifications 7.9, 7.18
- Voltage
 - changing AC input 8.17

W

- Watlow, see Temperature Controller

- Weight
 - DS Series 7.12
 - MAX Series & MAX II Series 7.2
- Width
 - Adjust, conveyor 5.30–5.32
 - calibrate conveyor 5.50
- Work area
 - aligning camera to 5.10
 - Lifter Plate, adjust 5.38
 - Tooling Plate 5.43