Automated Dispense System User Guide



Version 5.1
May 18, 2018
Part No. 22100079K



for use with models:
DS Series (DS9000, DS9000IL, DS9100, DS9100IL)
MAX Series
MAX II Series



for use with:
FLOWare[®] Software v2.9J+



prepared by GPD Global[®] Documentation Department.



611 Hollingsworth Street
Grand Junction, CO, USA 81505
tel: +1.970.245-0408 • fax +1.970.245-9674
request@gpd-global.com • www.gpd-global.com

Copyright © 2018 GPD Global[®] • All Rights Reserved

Table of Contents

Chapter 1: Introduction

Intended Audience	1.1
Organization of Manual	1.2
Conventions	1.2

Chapter 2: Machine Overview

Theory of Operation	2.1
Description	2.2

Chapter 3: User Interface

Operator Station	3.1
Keyboard & Mouse/Trackball	3.2
Controls	3.5
Safety Systems	3.8
Computer	3.10
Work Area	3.11
Head Mount Stations	3.13
Camera & Vision Systems	3.14
Surface Sensor	3.15
Calibration Station	3.17

Chapter 4: Basic Operations

Power On	4.1
Homing the System	4.2
Power Off	4.3
Password	4.5
Stop Operations	4.6
Safety Systems	4.8
Jog Operations	4.10
Run a Program	4.12
Activities When Machine is Idle	4.18

Chapter 5: Set Up Instructions

Mount Heads & Material	5.1
Load Product	5.7
Unload Product	5.8

Chapter 6: Operating Detail

Calibration During Program	6.1
Machine Controls	6.5
Notes	6.9
Offline Operations	6.11
Operating Modes	6.17
Operation States	6.19
Head Selection by Viscosity	6.22
UPS Control	6.23

Chapter 7: References

Legacy Controls & Operations	7.1
------------------------------------	-----

Index

List of Tables

1. Typographic Conventions	1.2
2. Symbol Conventions	1.2
3. Terminology Conventions	1.3
4. Typical Operating Cycle	2.1
5. Trackball Conventions.....	3.2
6. Using Accelerator Keys.....	3.3
7. Field Text Entry	3.4
8. Laser Operating Conditions	3.16
9. Consequences by Type of Stop Control	4.6
10. Jog Controls - How They Work	4.11
11. Loading Product according to Dispenser Type	4.15
12. Operations Requiring Operator Intervention	4.16
13. Needle Tip Position Guide	5.4
14. Receptacle Connections by Head Type.....	5.6
15. Run Mode Patterns	6.17
16. Inspection Mode Patterns	6.18
17. Slider Bar Operations.....	6.18
18. Operation States	6.19
19. Consequences by Type of Stop Control	7.6

Legal

Trademarks

- GPD Global® is a registered trademark of GPD Global, Inc.
- FLOWare® software is a registered trademark of GPD Global, Inc.
- ClearVu Vision™ and Taper-Lock™ are trademarks of GPD Global, Inc.
- Luer-Lok® is a registered trademark of Becton, Dickinson and Co.

Throughout this manual, trademarks are used. Rather than put a trademark symbol in every occurrence of a trademarked name, we state that we are using the names in an editorial fashion only and to the benefit of the trademark owner with no intention of infringement of the trademark.

Disclaimers

GPD Global® dispense systems are intended for the stated functions at the time of sale. GPD Global® is not liable for other uses.



IMPORTANT: Operation of a damaged machine may cause personal injury and invalidate the warranty

IMPORTANT:

L'utilisation d'une machine endommagée peut entraîner des blessures personnelles et invalider la garantie.

WICHTIG

Die Bedienung einer beschädigten Maschine kann zu Verletzungen des Bedieners sowie zur Ungültigkeit der Garantie führen.

IMPORTANTE

Il funzionamento di un'apparecchiatura danneggiata può causare lesioni personali e invalidare la garanzia.

IMPORTANTE

La utilización de una máquina averiada puede provocar lesiones e invalidar la garantía.

Safety Notices

Warnings



WARNING
Hazardous voltage
exists.
Refer to manual for
details.
Always wear proper
PPE.

HIGH VOLTAGE Due to the nature of the equipment, it should always be locked out during maintenance and service. Refer to *Energy Isolation Procedures* for details. No hazardous electrical work - Type 4 tasks - are to be performed on the equipment.



CAUTION
Hot surface.
Do NOT touch.
Use gloves and tools.
Refer to manual for
details.
Always wear proper
PPE and allow surface to
cool before touching.

WARNING Heated surfaces are found within the system and are indicated by a warning icon. Do not touch these surfaces or materials surrounding them. Avoid all heated surfaces or burns and injury may occur.



WARNING
Crush hazard.
Keep hands clear.
Lockout/Tagout
before servicing.



WARNING
Pinch Points.
Moving part can
crush or cut.
KEEP CLEAR.

WARNING Moving parts may trap or pinch hands and fingers.



WARNING Unintended release can occur most commonly during maintenance, as a result of operator error, when filling syringe material, or from fittings inside the cabinet. Refer to Dispenser User Guide and Dispense System Service Guide.

Larger unintended release can be caused when remote source of materials is not properly utilized. Contact manufacturer for more information. When the front shield is open, syringe pressure is zero (0).



WARNING Items that become solid waste include: dispense tubes and parts, filters, seals, and fittings. These items originate from the dispense pump, syringe, and external fill.



WARNING Recommended decontamination and decommissioning procedures:

- Some materials may be regulated wastes depending on the materials dispensed. Remove all contaminated parts and dispose of per MSDS / SDS instructions and local laws.
- Chemical Safety: Changes to the typical process chemistry or to the equipment could alter the anticipated environmental impact, change the risk of operating the equipment and possibly result in fire or destruction.

Precautions

Translated versions of the following safety precautions are used throughout this document and are listed together here:

Translations:

- [Consignes de sécurité](#)
- [Sicherheitsanweisungen](#)
- [Istruzioni di sicurezza](#)
- [Instrucciones de seguridad](#)



CAUTION: The protective earth ground connection symbol below identifies the machine's protective earth ground connection to a panel/chassis.



CAUTION: DO NOT override the safety package or else personal injury could result.



CAUTION: DO NOT open the safety shielding while a program is running or a safety violation message will appear and the program will abort.



IMPORTANT: Only qualified service or maintenance personnel should perform installation or maintenance procedures requiring access to the machine interior. Any screw-fastened panel is considered inaccessible to the operator.



OPERATOR SAFETY: GPD Global recommends you wear safety glasses whenever setting up, operating, or performing maintenance or troubleshooting procedures on the dispenser.



OPERATOR SAFETY: DO NOT operate the machine with the back hood open. Bolt the back hood shut before powering on the machine because there are no safety interlocks in that area to prevent access to moving parts.



OPERATOR SAFETY: If a conveyor is present, install barriers or signage in accordance with the applicable requirements to prevent access to the sides of the machine where (1) the conveyor rails protrude and (2) the cutouts in the safety shielding accommodate the conveyor.



CE SAFETY CERTIFICATION: DO NOT alter the machine in any way not specified in this document or CE safety certification will be void. Equipment is to be used only for its intended purpose.

Precaution Translations

Consignes de sécurité



ATTENTION: Le symbole de la connexion de terre ci-dessous identifie une connexion de terre de la machine à un panneau/châssis.



ATTENTION: NE PAS neutraliser le dispositifs de sécurité pour éviter des blessures corporelles.



ATTENTION: NE PAS ouvrir l'écran de protection quand un programme est en cours d'exécution, sinon un message de violation de la sécurité apparaîtra et le programme sera interrompu.



IMPORTANT: Seules des personnes qualifiées chargées de la réparation ou de l'entretien peuvent effectuer les procédures d'installation ou d'entretien exigeant l'accès à l'intérieur de la machine. Tout panneau vissé est considéré comme inaccessible.



SÉCURITÉ DE L'OPÉRATEUR GPD Global recommande le port de lunettes de protection lors du montage, du fonctionnement, de l'entretien ou de la réparation du distributeur.



SÉCURITÉ DE L'OPÉRATEUR NE PAS faire fonctionner la machine avec le capot arrière ouvert Verrouiller le capot arrière avant de mettre la machine en marche car il n'existe pas de dispositif de sécurité empêchant l'accès aux pièces mobiles.











SÉCURITÉ DE L'OPÉRATEUR Si vous utilisez un convoyeur, installer des barrières ou des signaux conformément aux règlements en vigueur pour empêcher l'accès sur les côtés de la machine où (1) les rails du convoyeur font saillie et (2) les découpes de l'écran de sécurité permettent d'installer le convoyeur.











CERTIFICATION SÉCURITÉ CE NE PAS modifier la machine d'une manière non spécifiée dans ce document au risque d'annuler la certification de sécurité CE. L'équipement doit être utilisé uniquement aux fins prévues.









Sicherheitsanweisungen

-  **VORSICHT!** Das unten abgebildete Symbol der Erdungsschutzverbindung zeigt die Erdungsschutzverbindung der Maschine mit einer Abdeckung/Grundplatte an. 
-  **VORSICHT!** Setzen Sie NIEMALS die Sicherheitseinrichtungen ausser Kraft, es koennte Personenschaden entstehen.
-  **VORSICHT!** Bei laufendem Programm dürfen Sie die Schutzabdeckung NICHT öffnen. Andernfalls wird ein Sicherheitsverstoß gemeldet und das Programm abgebrochen.
-  **WICHTIG** Installationen, bei denen auf das Innere der Maschine zugegriffen werden mußm dürfen nur von qualifiziertem Fachpersonal ausgeführt werden. Mit Schrauben befestigte Abdeckungen dürfen vom Bediener grundsätzlich nicht entfernt werden.
-  **BETRIEBSSICHERHEIT** GPD Global recommends you wear safety glasses whenever setting up, operating, or performing maintenance or troubleshooting procedures on the dispenser.
-  **BETRIEBSSICHERHEIT** Die Maschine darf NICHT bedient werden, wenn die hintere Abdeckung offen ist Die hintere Abdeckung vor der Inbetriebnahme der Maschine festschrauben oder verbolzen, da in diesem Bereich die sich bewegenden Teile nicht durch eine Sicherheitssperre geschützt sind.
-  **BETRIEBSSICHERHEIT** An Fließbändern müssen gemäß den einschlägigen Bestimmungen Schutzschranken oder Warnungen angebracht werden, damit die Bereiche der Maschine, an denen (1) die Räder des Fließbandes heraustreten bzw. (2) die Sicherheitsabdeckung aufgrund der Form des Fließbandes eingeschnitten wurde, vor Zugriff geschützt sind.
-  **CE-SICHERHEITZERTIFIZIERUNG** NIEMALS Änderungen an der Maschine vornehmen, die in diesem Dokument nicht aufgeführt sind, da sonst die CE-Sicherheitszertifizierung ungültig wird. Die Anlage darf nur für den beabsichtigten Zweck benutzt werden.

Istruzioni di sicurezza

-  **ATTENZIONE** Il simbolo del collegamento della presa di terra di protezione ubicato in basso identifica il collegamento della presa di terra ad un pannello/telaio. 
-  **ATTENZIONE** NON aggirate le disposizioni sulla sicurezza, potrebbero verificarsi danni alle persone.
-  **ATTENZIONE** NON aprire la protezione di sicurezza durante l'esecuzione di un programma altrimenti apparirà un messaggio di violazione di sicurezza ed il programma verrà interrotto.
-  **IMPORTANT:** Solamente personale di servizio o di manutenzione deve eseguire le procedure di installazione o di manutenzione richieste per accedere all'interno dell'apparecchiatura. Qualsiasi pannello fissato con viti va considerato inaccessibile all'operatore.
-  **SICUREZZA DELL'OPERATORE** La GPD Global raccomanda l'uso di occhiali protettivi durante la preparazione, il funzionamento, l'esecuzione della manutenzione o le procedure di localizzazione dei guasti sull'erogatore.
-  **SICUREZZA DELL'OPERATORE** NON far funzionare l'apparecchiatura con la protezione posteriore aperta. Chiudere con bulloni la protezione posteriore prima di dare corrente all'apparecchiatura in quanto non vi sono dispositivi di bloccaggio di sicurezza in quella zona per impedire l'accesso a parti mobili.
-  **SICUREZZA DELL'OPERATORE** Se vi è un trasportatore, installare barriere o segnali come previsto dai requisiti applicabili allo scopo di impedire l'accesso ai lati dell'apparecchiatura dove (1) le guide del trasportatore sporgono e (2) gli interruttori nello schermo di sicurezza alloggiavano il trasportatore.
-  **CE SAFETY CERTIFICATION:** NON alterare l'apparecchiatura in nessun caso a meno che non sia indicato da questo documento altrimenti la certificazione CE risulterà invalida. L'attrezzatura deve essere usata solo per lo scopo previsto.

Instrucciones de seguridad

-  **PRECAUCIÓN** El símbolo de conexión de seguridad a tierra indica que un panel o chasis de la máquina está conectado a tierra. 
-  **PRECAUCIÓN** NO saltarse el paquete de Seguridad, o alguna persona podría sufrir daños.
-  **PRECAUCIÓN** NO ABRA la protección de seguridad mientras se esté ejecutando un programa, si lo hace aparecerá un mensaje de violación de seguridad y se abortará el programa.
-  **IMPORTANTE** Los procedimientos de instalación y mantenimiento que requieren acceso al interior de la máquina sólo deben ser realizados por personal cualificado o técnicos de mantenimiento. Todo panel fijado por tornillos se considera vedado al usuario.
-  **SEGURIDAD DEL USUARIO** GPD Global recomienda el uso de gafas de seguridad al realizar procedimientos de configuración, utilización, mantenimiento o solución de fallos en el dosificador.
-  **SEGURIDAD DEL USUARIO** NO UTILICE la máquina con la cubierta posterior abierta. Para prevenir el acceso a las piezas móviles, trabe la cubierta posterior antes de encender la máquina, ya que esos componentes no tienen mecanismos de seguridad.
-  **SEGURIDAD DEL USUARIO** Si se utiliza un mecanismo transportador, instale barreras o letreros de señalización según sea necesario, para prevenir el acceso a los lados de la máquina, principalmente en lugares donde 1) los rieles sobresalen, y 2) en los bordes de los protectores, junto al mecanismo transportador.
-  **CERTIFICACIÓN DE SEGURIDAD DE LA CE** NO MODIFIQUE la máquina de ninguna manera que no esté específicamente indicada en este documento. De lo contrario, se anulará la certificación de seguridad de la CE. Sólo se debe usar el equipo para su finalidad específica.

Warranty

General Warranty. Subject to the remedy limitation and procedures set forth in the Section “Warranty Procedures and Remedy Limitations,” GPD Global warrants that the system will conform to the written description and specifications furnished to Buyer in GPD Global’s proposal and specified in the Buyer’s purchase order, and that it will be free from defects in materials and workmanship for a period of one (1) year. GPD Global will repair, or, at its option, replace any part which proves defective in the sole judgment of GPD Global within one (1) year of date of shipment/invoice. Separate manufacturers’ warranties may apply to components or subassemblies purchased from others and incorporated into the system. THIS WARRANTY IS EXPRESSLY IN LIEU OF ANY AND ALL OTHER WARRANTIES, EXPRESS OR IMPLIED, INCLUDING WARRANTIES OF MERCHANTABILITY OR FITNESS FOR A PARTICULAR PURPOSE.

Limitations. GPD Global reserves the right to refuse warranty replacement, where, in the sole opinion of GPD Global the defect is due to the use of incompatible materials or other damages from the result of improper use or neglect.

This warranty does not apply if the GPD Global product has been damaged by accident, abuse, or has been modified without the written permission of GPD Global.

Items considered replaceable or rendered unusable under normal wear and tear are not covered under the terms of this warranty. Such items include fuses, lights, filters, belts, etc.

Warranty Procedures and Remedy Limitations. The sole and exclusive remedy of the buyer in the event that the system or any components of the system do not conform to the express warranties stated in the Section “Warranties” shall be the replacement of the component or part. If on-site labor of GPD Global personnel is required to replace the non-warranted defective component, GPD Global reserves the right to invoice the Buyer for component cost, personnel compensation, travel expenses and all subsistence costs. GPD Global’s liability for a software error will be limited to the cost of correcting the software error and the replacement of any system components damaged as a result of the software error. In no event and under no circumstances shall GPD Global be liable for any incidental or consequential damages; its liability is limited to the cost of the defective part or parts, regardless of the legal theory of any such claim. As to any part claimed to be defective within one (1) year of date of shipment/invoice, Buyer will order a replacement part which will be invoiced in ordinary fashion. If the replaced part is returned to GPD Global by Buyer and found by GPD Global in its sole judgment to be defective, GPD Global will issue to Buyer a credit in the amount of the price of the replacement part. GPD Global’s acceptance of any parts so shipped to it shall not be deemed an admission that such parts are defective.

Specifications, descriptions, and all information contained in this manual are subject to change and/or correction without notice.

Although reasonable care has been exercised in the preparation of this manual to make it complete and accurate, this manual does not purport to cover all conceivable problems or applications pertaining to this machine.

1 Introduction

This manual is intended to familiarize the user with the operating procedures for both GPD Global®, automatic, dispense system lines: the MAX Series and the DS Series. Wherever information for the systems differ, the necessary specifications are noted.

MAX Series

A typical conveyor unit



DS Series

A typical conveyor unit

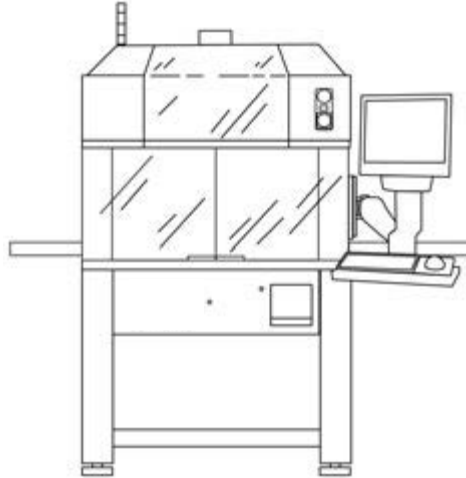

Intended Audience

This manual is intended as a guide for dispenser operators. Some initial training is suggested. After training, the operator should be familiar with basic machine procedures such as how to:

- operate the safety shield system,
- start the system,
- configure the system for a particular product,
- load a program,
- run a program,
- clear errors, and
- change and clean heads (valves/tools).

An assigned Engineer should know all operating procedures and should be able to create and modify programs.

Organization of Manual

This manual is organized as follows:

Introduction

Introduction to what is covered in this manual and for whom it is written. Explanation of the symbolic and terminology conventions used in this manual, plus a list of related documents.

Machine Overview

Overview of the primary features and operational sequences typically used during dispenser operations.

User Interface

In-depth description of the primary features used by the operator and how they function.

Basic Operations

Basic procedures you will use repeatedly to operate the machine, plus a step-by-step guide on how to run a typical program.

Set Up Instructions

Commonly used setup procedures such as how to install valves and tools, and load and unload product.

Operating Detail

Procedures and background information for topics that affect and support operations at the operator level.

Conventions

Consistent formats are used throughout this manual to help you find and understand the information you need. The following tables list the text, symbols, and terminology conventions used in this manual.

Table 1: Typographic Conventions

Format	Description
LARGE CAPITALS	Used when referring to a button displayed on the computer monitor screen.
Upper/Lower Case	Used when referring to a specific viewing area (panel or field) on the computer monitor screen.
<i>italics</i>	Used when referencing a title within this or another document and for graphic captions.
bold	Used to emphasize a word or phrase.

Table 2: Symbol Conventions



Symbol	Description
	Calls attention to hazards or hazardous conditions that could cause personal injury but are not likely to be life-threatening.
	Calls attention to important information that should be read and considered before taking action.
>	Used to identify submenu selections. For example: To perform a data backup, click on Utilities > Backup > Data Only.

Table 3: Terminology Conventions

Term	Description
jog jogging	The gantry moves in X, Y, and Z directly controlled by using the trackball and keyboard to position the camera and teach program coordinates.
screen	The dynamic display area on the computer monitor.
window	The viewing area displayed on the computer monitor screen.
panel	An area within a window.
head	Any of the various valves and tools used to process product on the dispenser (that is, valves for dispensing material, tools for pick and/or place, etc.).
cursor	The pointer on the screen that indicates: <ul style="list-style-type: none">• position of text selection, insertion, or deletion• direction and speed of camera movement during jog operations.

2 Machine Overview

This section is an overview of the primary features and the operational sequence typically used by the operator during operations of a GPD Global automatic dispense system. This overview provides an adequate understanding of most machines. Your system may not have all the described features, may have features not described here, or some features may be located differently on the machine.

Theory of Operation

A typical operational sequence for an automatic dispense system:

1. The operator powers on the machine. A prompt to home the system appears.
2. The operator clicks OK and the system homes all gantry axes (Z, Y, X).
3. The operator may enter a personal password.
4. The operator selects and activates an existing process program. A prompt displays the heads, materials, needle sizes, and air pressure to be used in each mount position.
5. The operator installs the necessary heads and materials and clicks OK to continue.
6. A calibration routine runs automatically for each head used in the current program.
7. When the calibration routine is complete, the operator sets up the work area (stand-alone or conveyor) to accept the product to be processed:

Table 4: Typical Operating Cycle

Configuration	Configuration-dependent Steps
Stand-Alone machine	<p>A - The operator opens the safety shield, loads product onto the dispensing area work surface, and closes the safety shield.</p> <p>B - The operator resumes the program. The system executes the selected program. When the program is complete, the operator is prompted to either load a new product or cancel the program.</p> <p>C - The operator opens the safety shield, unloads the product, and either:</p> <ol style="list-style-type: none"> (1) repeats the above steps as many times as desired, replenishing dispensing material as necessary, or (2) cancels the program to end processing.
Conveyor machine	<p>A - When a product is ready, it travels downstream from upstream equipment to the system conveyor nest station. The system automatically executes the selected program. The conveyor transports the processed product downstream.</p> <p>B - The operator replenishes head dispensing material as necessary. Processing continues until product is unavailable from the upstream equipment or the operator cancels the program.</p>

8. When processing is complete, the operator:
 - a. Clears the machine of all product.
 - b. Purges and unloads the heads and any dispensing materials.
 - c. Powers off the machine.

Description

For purposes of examining the machine from the operator point of view, the machine can be divided into two basic areas of interest: the inside and the outside.

- Inside the machine (behind safety shield) is the [Work Area](#) (pg 2.2) where all automatic operations occur.
- Outside at the [Operator Station](#) (pg 2.5) (at front of machine), the operator interfaces with the machine and control software.

Work Area

The work area is enclosed by the machine hood and safety shielding. All automatic product-processing operations occur within the work area.

Product either travels into the work area automatically on a conveyor or is secured on a plate/fixture by the operator. Product typically remains stationary during process operations while the heads (valves and tools), vision system, and surface sensor travel to programmed coordinates by means of a gantry system.

A calibration system is used to establish precise position data.

Conveyor or Stand-Alone

Each dispenser is built as either an inline conveyor system or a stand-alone (batch) system.

Conveyor systems use a lifter plate in the dispense area to lift product slightly above the conveyor belts and support product during the dispensing process.

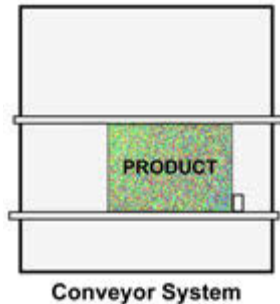

TOP VIEW
Simplified view of
conveyor system work area.

Stand-alone systems use fixed rails and adjustable crowders to keep product securely in place during the dispensing process.

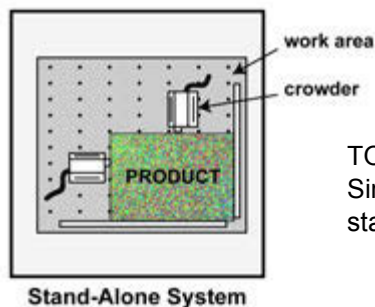

TOP VIEW
Simplified view of
stand-alone system work area.

Gantry

An overhead gantry supports and provides XYZ movement for the heads, camera, and surface sensor.

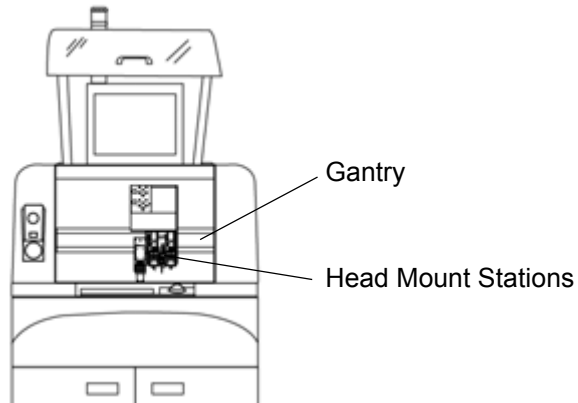

Head Mount Stations

Heads (valves and tools) are installed in mount stations on the gantry Z-plate. Power and air lines from the heads plug into a receptacle panel located above the mount stations.

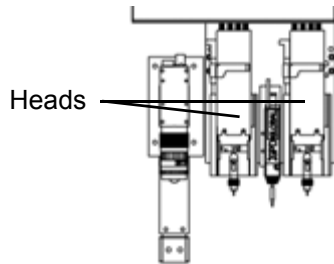

Camera & Vision

The downward-looking camera is mounted to the gantry Z-plate and works with the vision system to verify product alignment and the XY location of the head tip prior to the dispensing process.

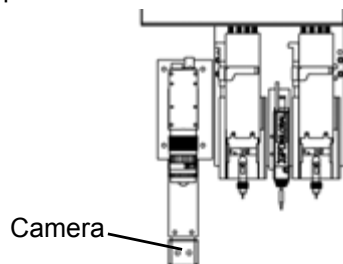

The machine is configured with either an automatic or manual vision system:

- An automatic vision alignment system automatically performs the functions of alignment, locating, and pattern-recognition.
- For a manual alignment vision system, those same functions are performed by the operator with the use of the video screen and keyboard.

Surface Sensor

A surface sensor, mounted between the first and second head mount stations, locates the product surface before operations begin. There are two types of surface sensors:

- A laser surface sensor senses the product surface with a beam of light.
- A contact surface sensor that descends until the surface sensor tip touches the product surface,

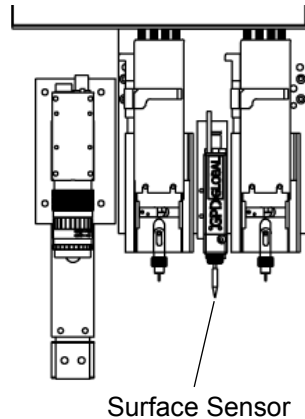

Calibration Station

The dispenser uses the calibration station to establish location data for the head dispense tip. The calibration station provides a fixed location where automatic XY location and Z height can be established for dispense needle position and camera offset. The calibration station is typically located at the front of the machine at the front of the work area.



Top view of typical calibration station (ceramic & paper style)

Lighting

Low heat and long life LED lighting is mounted in the hood to illuminate the general work area inside the dispenser and along the front interior to illuminate the calibration station and nest area.

To prevent the lighting from interfering with the vision process, the LEDs are software controlled to automatically turn off any time a vision-type function, such as the calibration process or a fiducial search, occurs during a program run.

Optional Equipment

Optional equipment is a typical part of any dispenser, so remember that your system may not have all the described equipment, may have equipment not described in this manual, or some equipment may be located differently on your machine.

Operator Station

All elements of the operator station are accessible from the front of the machine. A monitor, keyboard, and trackball provide access to the control software. Mechanical override controls and the computer media drive are within easy reach. Safety systems provide immediate feedback.

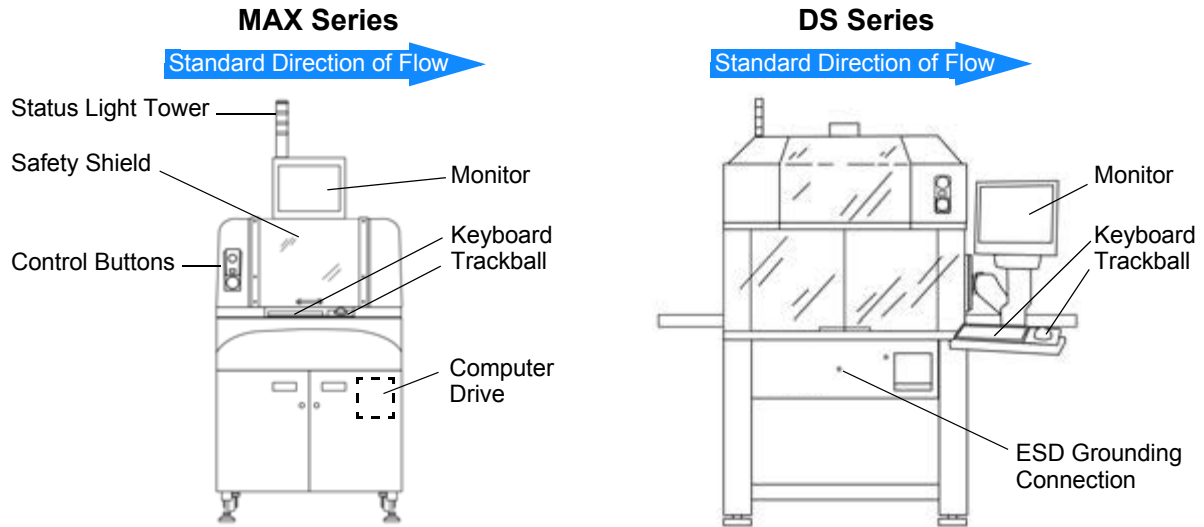

Monitor, Keyboard, Trackball

The operator uses a monitor, keyboard, and trackball to interact with the machine control software. Depending on the dispenser model, the monitor may be mounted either on top of the machine or at the side as part of an operator station assembly on a swing-arm mount. The keyboard and trackball are located within easy reach at the front of the machine or in the operator station assembly at the side.

Control Software

The dispenser control software, FLOWare software, is a real-time multi-tasking operating system. It is used to control virtually all the devices on the machine and allows for accurate monitoring and infinite control of the dispensing process.

Controls

All but a few of the controls used to operate the dispenser are contained within the control software. The mechanical controls provided are used to power on and shutdown the machine and, in an emergency, stop all machine movement. Interrupting a dispensing process with software controls allows the user to resume the process, whereas interruption with mechanical controls aborts the process. Some dispenser models use manual controls to set certain dispensing valve and temperature controller criteria.

Safety Systems

Any time a safety violation occurs, a safety message is displayed on the monitor, visual signals using colored lights occur in the status light tower, and an audible alarm may sound.

All safety shields are equipped with safety interlocks so all machine movement stops if a safety shield is opened during machine operations.

Computer

Computer drives and ports are accessed from the front of the machine. The hard drive access indicator light is visible from the front of the machine. All computer controls are inaccessible to the operator

3 User Interface

This section presents a more in-depth description of the primary features typically used by the operator during operations and how they function. This information is presented in the general order in which you encounter them as you approach and use the machine, from those at the front of the machine exterior to those inside the work area.

Your system may not have all the described features, may have features not described here, or some features may be located differently on the machine.

Operator Station

The operator station consists of a monitor, standard keyboard, and trackball. The operator uses these features to interact with the control software. Monitor location is dependent on machine model. The keyboard and trackball are located within easy reach at the front of the machine or in the operator station assembly at the side.

An ESD grounding connection is also located on the front of the machine for operator use.

MAX Series

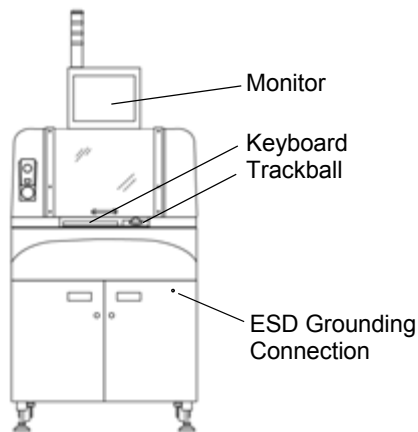

DS Series

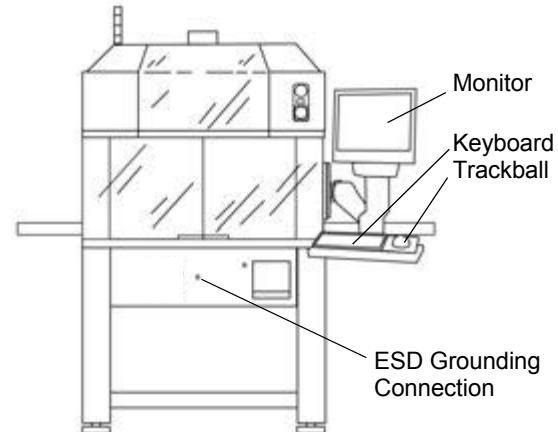

Keyboard & Mouse/Trackball

Cursor

The cursor (pointer) can be moved anywhere on the monitor screen with the ball section of the trackball.

Trackball

Use the trackball to position the cursor on the monitor screens and to move the gantry.

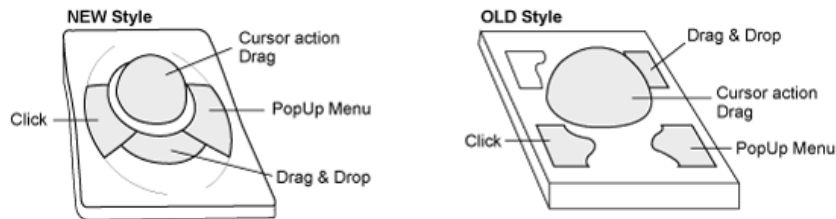

Select all or part of the contents in a field. There are several ways to select field contents, and each method obtains slightly different results. You can either click-and-drag or multiple-click on a field.

1. If you **single-click** on a field, press the lower left trackball key, and drag the cursor, you can be selective about the data selected.
2. If you **double-click** on a specific item within a field, you can select that single item (a single word, a value, or a unit of measure).
3. By **triple-clicking** on a field, you can select the total contents (a value AND the unit of measure or all text) of a field.

The following conventions are used in this manual for trackball actions:

Table 5: Trackball Conventions

Term	Action
click	Press the Click trackball button and immediately release it.
double-click triple-click	In rapid succession, click the Click trackball button for the applicable number of times.
drag	As you move the cursor down a menu with the trackball, each menu selection is highlighted in turn. Frequently, you will select a menu item by dragging the cursor down the menu until the item you want is highlighted, and then releasing (or sometimes clicking) the Click trackball button.
drag & drop (move)	Press and hold the Drag & Drop trackball button while moving the cursor, then release the button.
position cursor	Move the cursor by moving the Ball portion of the trackball.
open Pop-up menu	Position the cursor at the appropriate screen location and press the Click trackball button.

Keyboard

When used in reference to hardware, the term *key* is understood to refer to a control located on the keyboard and *button* is understood to refer to a control located on the trackball.

Accelerator Keys

Various accelerator keys are provided to accommodate navigation by keyboard rather than by trackball.

Table 6: Using Accelerator Keys

Item Affected	Use These Keys	Notes
select a menu item	ALT key + first letter	A menu item that displays with an underlined first letter may be selected by pressing the ALT key and the underlined letter.
select a panel	CTRL key + first letter	A <i>selection panel</i> may be selected by pressing the CTRL key and the first letter of the panel title (rather than clicking the Panel Selection button). For example, to select the Vision panel in the Program Detail window, press the CTRL key and the V key.
enter mount location	ALT key + 1, 2, 3, 4, or 5 key	Enter a value in any Mount Position field by pressing the ALT key and a number (1-5) key.
enter gantry	ALT key + A, B, or C key	Enter a value in any Gantry field by pressing the ALT key and a letter (A-C) key.

Arrow Keys

Use the arrow keys to move the cursor sequentially up/down lists or forward/backward through text and numeric values.

Tab Key

Either move the cursor with the trackball and click on a field to select it or press the TAB key repeatedly to move through the fields sequentially until the cursor has reached the destination field.

Use the TAB key to move the cursor sequentially from field to field. Normally, the TAB key will not tab through a text field; rather, use of the TAB key within a text field creates tab spaces. However, pressing down the CTRL key while using the TAB key will move the cursor through all fields, in sequence, without exception.

NOTE: The TAB key does not always work on the main window.

Text Entry

Use the keyboard to type text entries after positioning the cursor in the appropriate field. When entering text or values:

Table 7: Field Text Entry

To	Action
select desired field	click on desired field
move forward from field to field	<Tab> to desired field
move backward from field to field	<Shift> + <Tab> to desired field
select all text/numbers in a field	double-click OR click and drag

Numeric Entry

Select desired field and type a numeric value using the keyboard, or click the default box next to the field to return the field to its default value. When entering a value, you may need to erase (backspace key) the prior value before entering the new value.

A discussion about units of measure is located in the *Dispenser FLOWare Software Guide*.

Controls

This section identifies and describes the location and purpose of each mechanical control present on the machine. Included are the controls that allow you to turn machine power on and off, stop and disable all motor movement, plus temperature controllers and head dispensing controls.

IMPORTANT: Does your system use the **legacy control panel**? To find out, refer to [Legacy Controls & Operations](#) (pg 7.1). You'll also find the alternative/legacy content you'll need there.

Power On & Off

The controls used for normal power on/off operations are located on the front of the machine:

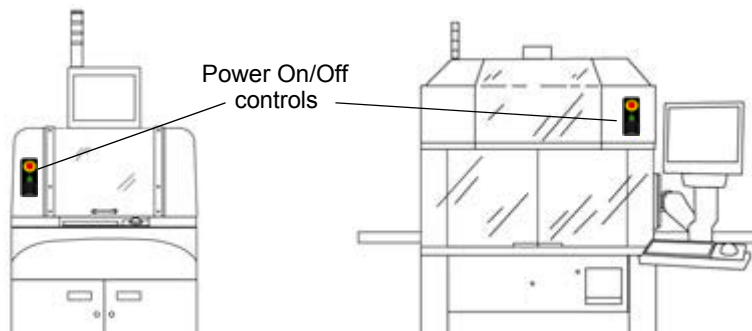

For normal power on/off operations, use the following designated switches:

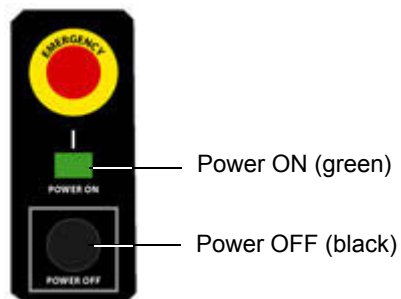

To disconnect all power to the machine, turn off the main power switch on the rear panel.

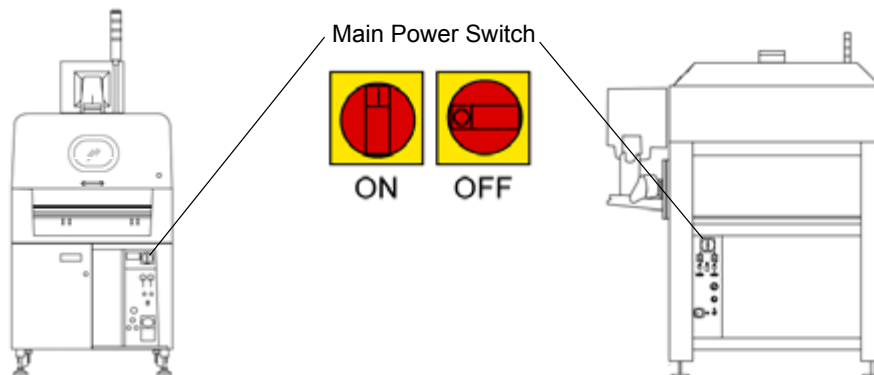

DS SERIES ONLY - OLD STYLE

The location of the controls on old style DS Series machines may differ from that mentioned in the previous section:

Emergency Stop / Motion Stop

Depending on customer requirements, older style DS Series machines might be equipped with either a red Emergency Stop button or a yellow Motion Stop button. The same front hood location is used for both buttons.

Power On / Off

The Main Power switch on older style DS Series machines is used both for normal power on/off operations and for disconnecting all power to the machine.

Emergency Stop

Press the Emergency Stop switch to stop and disable all motor movement. Using the Emergency Stop button has the same result as tripping the safety interlock circuit - a safety violation message will display and any active program will abort.

Use of the Emergency Stop button aborts any active program, and a machine reboot is unnecessary.

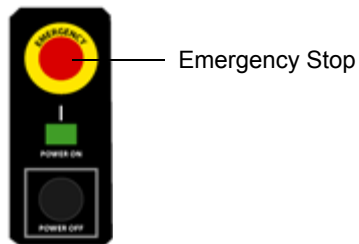

Power Off

Pressing the Power Off button stops all machine movement and shuts off the power. Use of the Power Off requires that you reboot the machine before operations can be resumed.

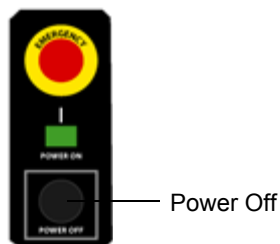

SOFTWARE ALTERNATIVE

Instead of using the Emergency Stop button, you may use the PAUSE and RESUME software buttons located on the main button bar of the main window. This serves to pause and then resume operations where they left off without aborting the program.

Monitor Power

The monitor powers on and off automatically with the machine. The location of the manual monitor power control, should it be needed, may vary with monitor model.

Temperature Control

Temperature for such devices as the material heat and needle heat options is controlled and monitored with either temperature controllers or through the control software.

If your machine uses temperature controllers, refer to the technical information available in the *Dispense System Service Guide* for modifying temperature controller criteria.

Temperature controllers are located inside the machine cabinet, typically inside a rear service panel. In older dispenser models, the temperature controllers are mounted inside the front service panel (MAX Series models) or between the keyboard and monitor (DS Series models).

Safety Systems

All safety shields are equipped with safety interlocks to stop all machine movement whenever a safety shield is opened during machine operations. Opening a safety shield removes all air pressure from the machine, including any syringe valves mounted on the machine. All valve heads and the lifter plate, if present, maintain their current positions and do not fall upon the release of air pressure. The vacuum port is not affected by safety shield activity.

A safety message displays on the monitor any time a safety violation occurs. All safety shields must be closed before the safety message can be cleared.

In addition to displaying a safety violation message when a safety shield is opened, the machine can be programmed to sound an audible alarm and/or display visual signals using the colored lights in the status light tower.

Safety Shields

The safety shields are all equipped with safety interlocks. If a safety shield is opened during machine operations, all machine movement stops and any active program will abort.

Safety shield opens upward

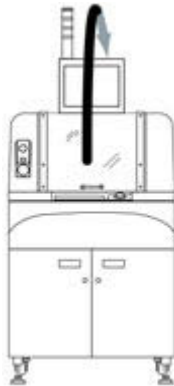

Safety shield opens upward & safety doors open to the sides



CAUTION: Do not override the safety package or else personal injury could result.

ATTENTION
[NE PAS neutraliser](#)

VORSICHT!
[Setzen Sie NIEMALS](#)

ATTENZIONE
[NON aggirate le](#)

PRECAUCIÓN
[NO saltarse el paquete](#)

Status Light Tower

The status light tower indicates machine status conditions by turning on colored lights, each of which represents a given state. Numerous variables associated with the status light tower can be modified by the customer. Several examples of these variables are as follows:

- the color of the light when a condition occurs,
- the message displayed,
- the light flashing speed,
- whether or not the audible alarm sounds,
- the color of the light when the condition is cleared,
- and whether or not the condition is logged.

For further details, refer to your company's site manual and the *FLOWare Software Guide*.

Audible Alarm

The user can control the optional audible alarm with an ON/OFF toggle control box on the main window. If the user sets the audible alarm to on, the following conditions will sound the alarm:

- when any manually mounted item requires attention,
- any time the machine times out, and
- when a head needs attention.

For further details, refer to [Audible Alarm](#) (pg 4.9).

Computer

Computer drives and ports are available behind the door of the front panel. All computer controls are inaccessible to the operator.

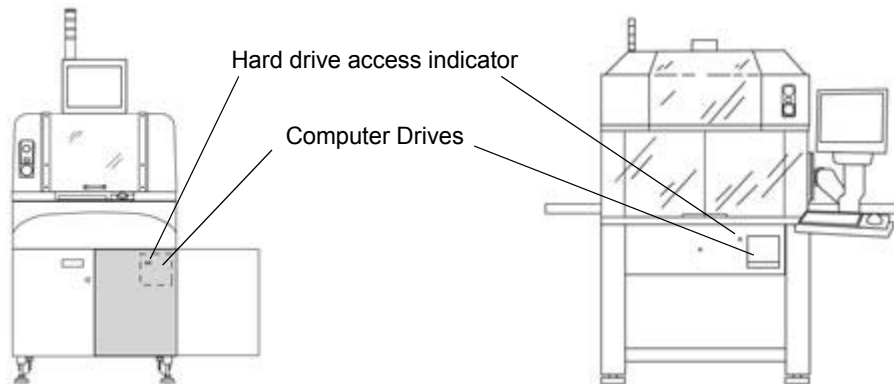

USB Port

When a USB (universal serial bus) device is plugged into the USB port, the computer operating system recognizes the device as a removable drive and assigns it a drive of `/dos/c`.

A USB device can be used with the Import and Export features and all types of Backup and Restore utilities except a full system backup.

Loading USB

A USB device can be plugged into the USB port any time the system is running. If a USB device is loaded prior to starting an import, export, backup, or restore function, the system will skip displaying the *mount a USB device* prompt.

Removing USB

To remove the USB device, either:

- wait until a system prompt tells you to remove the USB device, or
- click in the main control window menu bar on Utilities > Unmount USB and then remove the USB device.

 **CAUTION:** Do not remove a USB device unless the system prompts you to do so or unless you have used the Unmount USB command; otherwise, the USB port will be unusable until the system is rebooted and anything you may have written to the USB device may be lost.

Data Transfer Utilities

Refer to the *FLOware Software Guide*.

Removable Hard Drive

The master disk(s) may be removed for security purposes. For details, refer to *Removable Hard Drive* under *COMPUTER* in the *Special Topics* section of the *Dispense System Service Guide*.

Work Area

The work area is enclosed by the machine hood and safety shielding. Product either travels into the dispense area within the work area automatically on a conveyor or is secured on a plate by the operator.

Work Area vs. Dispense Area

All dispenser models have a *dispense area* contained within the *work area*.

work area

The entire work envelope or table top area inside the dispenser hood.

dispense area

The space within the work area that the head tip(s) can reach. The size of a dispense area is affected by the station position of the active head.

Conveyor vs. Stand-Alone

A dispenser is either configured as an inline conveyor system or a stand-alone (batch) system.

Conveyor models

Typically, conveyor models have a nest dispense area with a lifter plate and a set of spring-loaded pins and vacuum support pins to raise product off the conveyor belts during processing. The standard MAX Series conveyor has a single dispensing nest position; the standard DS Series conveyor includes an entrance buffer, a dispensing nest, and an exit buffer.

MAX Series - TOP View
(standard single nest conveyor)

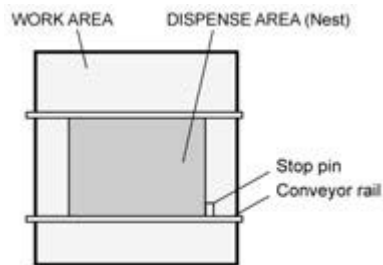

DS Series - TOP View
(standard 3-position conveyor)

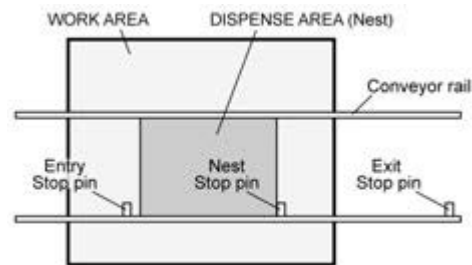

Standard Direction of Flow →

Stand-Alone models

The stand-alone models have a dispense area with fixed product rails and adjustable product crowders. Product is secured in place mechanically with pneumatically operated crowders.

MAX Series - TOP View

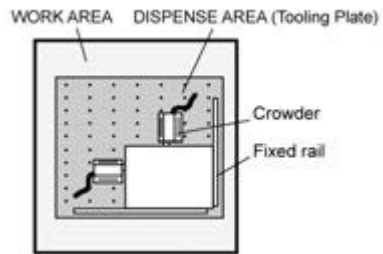

DS Series - TOP View

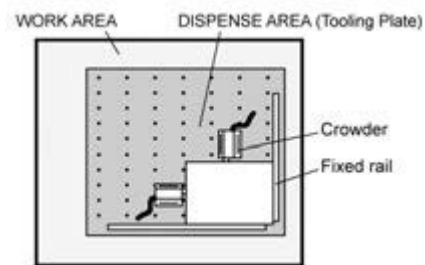

Standard Direction of Flow 

Head Mount Stations

A system of mount stations attached to the gantry accommodates multiple, easy-to-mount heads (valves and tools). Installing a head involves selecting the correct type of head for the program, installing it in the correct mount station, and then connecting the head power and/or air lines to the correct receptacle(s) on the machine. Heads may be mounted in advance of running a process while the machine is idle or when the system prompts the operator to mount them during the run process.

Station Positions

A machine may support between one and five mount stations; the number of stations available depends on machine model and configuration. The position of each mount station is designated from left to right as station 1, station 2, etc.

Typically, a vision system camera is mounted left of station 1 and a surface sensor is mounted between stations 1 and 2. The various valves and tools available from GPD Global can be mounted in almost any or all station positions.

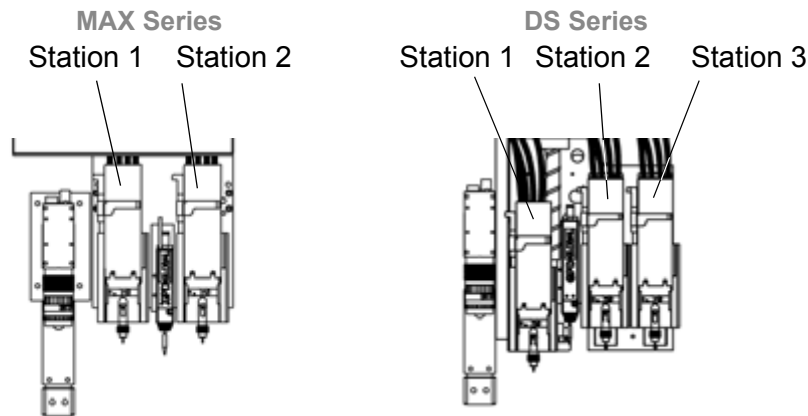

Receptacles

Receptacles provide air pressure and/or power source for each station. The number and type of receptacles required by any particular head mounted in a station depends on what that head needs to function. Typically, all receptacles are within easy reach on a panel located above the head mount stations. A specific set of receptacles corresponds to each station.

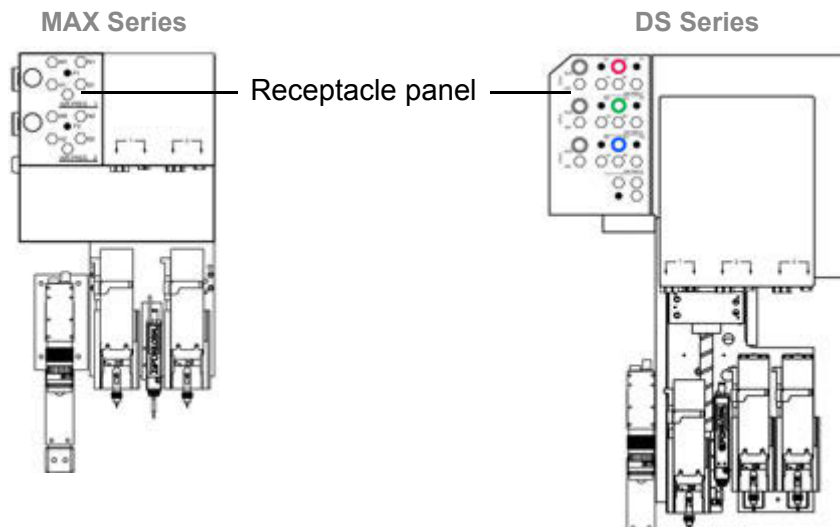

Camera & Vision Systems

The camera - mounted next to the heads - works with the vision system to verify product alignment and the XY location of the valve tip prior to the dispensing process. Your machine is configured with either an automatic or manual vision system. An automatic vision system locates images automatically, while a manual, fixed lens system requires an operator to manually align the camera over parts.

automatic vision system

(standard) uses a video camera and a fixed focus lens.

automatic ClearVu Vision system

(optional) uses a video camera and a programmable zoom/focus lens. The programmable zoom and focus is specific to a fiducial/pattern image and program.

manual vision system

(optional) uses a video camera and a fixed lens.

Fixed Video Camera

The manual alignment vision system requires that an operator manually adjust and verify alignment of fiducials using the video screen and keyboard. For details, refer to *Lens Focus* in the *FLOware Software Guide*.

Programmable Zoom/Focus Lens Camera

The Programmable Zoom/Focus Lens Camera is a part of the ClearVu Vision option. This automatic vision alignment system automatically performs the functions of alignment, locating, and pattern-recognition training with a software-controlled, programmable zoom/focus lens camera.

This camera must be adjusted through the software – it cannot be manually adjusted. Lens focus/zoom and lighting adjustments are controlled through the software rather than by means of mechanical adjustments. Live video provides immediate feedback as these software camera control adjustments are made.

NOTE: Programmable zoom and focus values are specific to a fiducial/pattern image and program. Therefore, adjusting the camera and/or the lighting may require changing all patterns used by your programs.

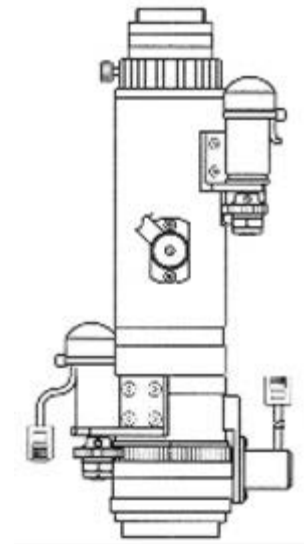

Surface Sensor

Before operations begin, the machine has to know where the product surface is located in space. A surface sensor, mounted between the first and second head mount stations, serves this purpose by relating the actual surface location to the system.

There are two types of surface sensors: contact and laser. A contact type of surface sensor is shown at right.

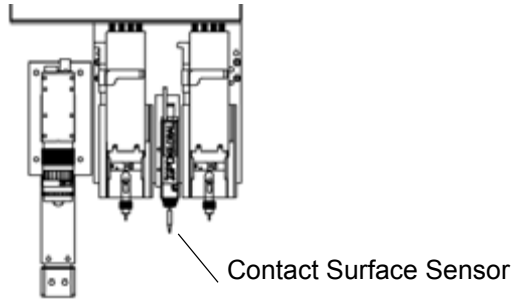

Contact Surface Sensor

The contact surface sensor locates the product surface by descending downward until the surface sensor tip touches the product surface. The touch probe tip is replaceable in case of accidental damage.

~ continued ~

Laser Surface Sensor

The optional laser surface sensor senses the product surface with a beam of light by using an opto- electronic displacement measurement system with an integrated digital signal processor. Without contact, the laser measures distances against a wide variety of material surfaces using the principle of optical triangulation.

Table 8: Laser Operating Conditions

LED Color	State
green	OK
yellow	mid-range
red	poor target or out of range

An LED, mounted in the surface sensor housing, indicates the current laser operating condition (when operating voltage is available).



DANGER LASER RADIATION - DO NOT STARE INTO BEAM

Maximum Output of 1 mW, Emitted wave length of 670 nm, Pulsed radiation

CLASS II LASER PRODUCT, in conformity to IEC825-1 11.1993 This laser product emits an invisible light beam and although the laser output is low, looking directly into the laser beam must be avoided.



CAUTION OPERATOR SAFETY - Pay attention to all safety precautions:

1. There is a risk of laser radiation if this device is used in any way other than as specified.
2. Avoid direct eye contact with the laser. Do not look directly into the laser beam or touch it. Class II levels of laser radiation are considered to be a chronic viewing hazard.
3. Ensure adherence to the limitations of the ratings and functions of this product.
4. When approaching within 2 m of the emitter, wear laser protective glasses.



IMPORTANT Temperature Influences - The sensor requires a warm up time of at least 15 minutes to achieve uniform temperature distribution in the sensor. If measurement is performed in the micron accuracy range, the effect of temperature fluctuations on the sensor holder must be considered.

Calibration Station

Calibrating the heads is an integral and automatic part of program execution. The calibration station provides XYZ needle calibration and automatic vision calibration.

Typically, the calibration station is mounted in the work area just inside the safety shield. It is used prior to each program run to establish accurate offsets between the active heads, the touch probe, and the camera in X, Y, and Z axes.

Various models of calibration station are available to accommodate materials that require different lighting scenarios in order to be visible at the calibration dot. As of 2010, the compact style is the standard model of calibration station.

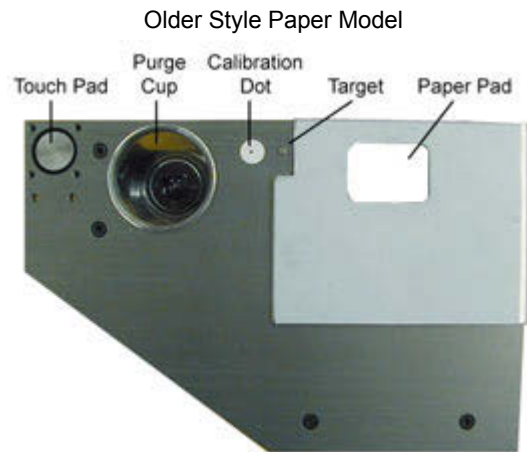
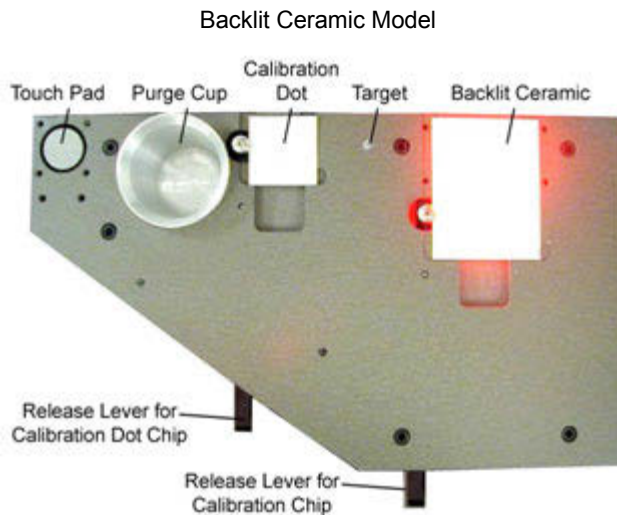
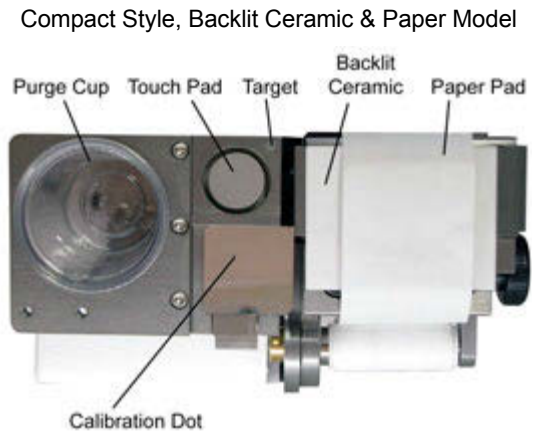

Touch Pad

Used to calibrate the needle z position to the mounted surface sensor.

Purge Cup

Disposable container catches discharged materials during valve purging and cleaning operations.

Calibration Dot

Location used to calibrate the distance traveled on the screen with the distance traveled by the gantry.

Target

Location used to calibrate various base locations for heads and the surface sensor.

Paper Pad

Automatically fed paper tape used to calibrate the camera to needle offset.

Backlit Ceramic

Backlit ceramic chip provides increased contrast for hard-to-see or shiny materials.

Release Levers

Used to load and release chips at the calibration dot site or ceramic chip site.

Impression Pad

Not shown. Needle tip impression in the soft metal tape pad provides a visible mark in place of a dispensed dot for hard-to-see materials (white, clear, etc.)

Standoff Calibration Pad

Not shown. Optional. Location used to calibrate the optional rigid needle standoff.

4 Basic Operations

This section covers the basic operation procedures you need to know before you begin machine operations. A typical procedure for running a program is also provided here. You will also find a list of things you can do with the system while the machine is idle.

This chapter describes how to:

- turn the machine on and off properly,
- gain access to the control software,
- stop and resume machine operations,
- move the gantry in order to position the heads and camera, and
- run a program.

Power On

To power on the machine:

1. Read all safety and operating instructions prior to operating the machine.

IMPORTANT: Does your system use the **legacy control panel**? To find out, refer to [Legacy Controls & Operations](#) (pg 7.1). You'll also find the alternative/legacy content you'll need there.

2. Verify the black Power Off button is pulled out.
3. Turn on the machine by pressing the green Power On switch. The system will prompt you to home the XYZ gantry when you turn on the power and the booting process has finished. The system must complete the homing sequence before other operations are possible. Refer to [Homing the System](#) (pg 4.2).

Homing the System

Homing the system is a standard part of the power on procedure.

1. Wait until the system has completed the booting process. This may require waiting several minutes while status information displays.

The main window and a prompt to home the system will display when the booting process is complete.

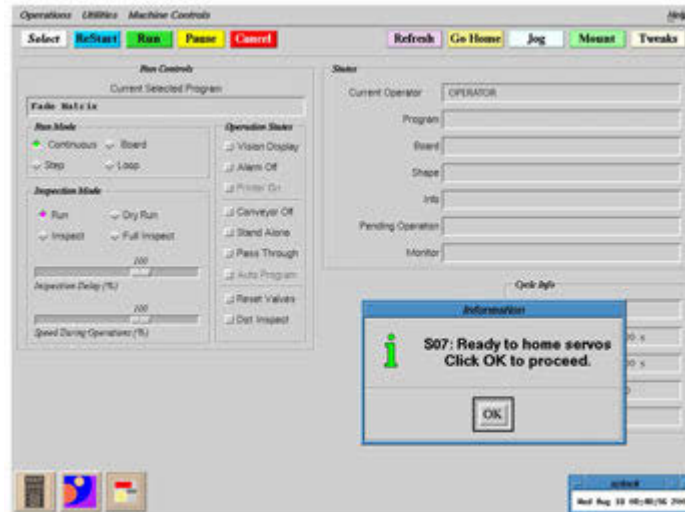

Click OK to home the system. Homing defines where the gantry is for the system and is complete when all homing status messages disappear. When only the main window remains, you may proceed with normal operations.



CAUTION: Do not override the safety package or else personal injury could result.

ATTENTION
[NE PAS neutraliser](#)

VORSICHT!
[Setzen Sie NIEMALS](#)

ATTENZIONE
[NON aggirate le](#)

PRECAUCIÓN
[NO saltarse el paquete](#)



CAUTION: Do not open the safety shielding while a program is running or a safety violation message will appear and the program will abort..

ATTENTION
[NE PAS ouvrir l'écran](#)

VORSICHT!
[Bei laufendem Pro-
gramm](#)

ATTENZIONE
[NON aprire la pro-
tezione](#)

PRECAUCIÓN
[NO ABRA la protección](#)

Power Off

Before powering off the machine, end any active program and perform a proper shutdown described in the following procedure:

IMPORTANT: Does your system use the **legacy control panel**? To find out, refer to [Legacy Controls & Operations](#) (pg 7.1). You'll also find the alternative/legacy content you'll need there.

Prepare for Shutdown

Before you can perform the shutdown procedure, you must end any active program. It is also recommended that you unload all product from the dispense area and remove and clean the heads.

To prepare for shutdown:

1. Stop program execution with one of these methods:
 - If the Mount Board prompt is displayed, click ABORT, or
 - Click CANCEL on the main button bar.
2. After the program has ended, remove all product from the dispense area. For details, refer to [Unload Product](#) (pg 5.8).
3. Unload all heads (valves and tools):
 - a. Click REFRESH on the main button bar to move the gantry to the front of the machine where you can access the heads.
 - b. Remove the heads. For details, refer to [Mount Heads](#) (pg 5.1).
 - c. Clean the heads. For details, refer to head cleaning instructions detailed in *Valves* under *CLEAN* in the *Periodic Operations* section of the *Dispense System Service Guide*.

Shutdown

The machine can be left powered on as long as the safety system has not been bypassed, however, GPD Global recommends that you power off equipment when it is not in use.

To shutdown and power off the machine:

1. Perform the [Prepare for Shutdown](#) (pg 4.3) procedure.
2. From the main menu bar, click on Operations > Shutdown System. A shutdown verification prompt displays.
3. Click YES to shutdown the system or CANCEL to abort the shutdown. Wait until a System Stopped prompt displays.
4. Power off the machine by pressing the black Power Off button.
5. Perform the [Lock-Out](#) (pg 4.4) procedure.

Energy Isolation Procedures

Lock-Out



To ensure energy isolation, lock-out the equipment:

1. Turn off customer-supplied Lock-Out switch.
2. Turn off main power switch.
3. Install a lock or tag per your facility energy isolation procedures.
4. Test if system will start by pressing the Power On switch.
5. Test volt meter on known voltage source:
 - Test for presence of electrical power at TB1 and TB2 or at EMI Filter inlet L1 or L2.
 - Reconfirm volt meter on known voltage source.

Release Equipment from Lock-Out



To release equipment from customer-supplied Lock-Out switch:

1. Remove all tools, parts, and materials from the system.
2. Verify any and all work to ensure proper installation, polarity, connection.
3. Close all doors, covers, and shields.
4. Using facility-specific procedures, remove customer-supplied locks and/or tags.
5. Pull out the Power Off button.
6. Ensure the power cord is connected.
7. Turn on main power switch, watching for electrical or other failure.
8. Follow the [Power On](#) (pg 4.1) procedure.

Password

Access to various system features is controlled by passwords. Access rights are assigned to a user name and each user name is password protected by a unique user-defined password. Passwords are typically supplied by the person who administers the system.

NOTE: When the machine is powered on, the default password in effect allows minimal access (operator level) to the system.

Enter Password

To enter a password:

1. From the main menu bar, click on Operations > Enter Password.
2. Enter a password and click OK.



Clear Password

To cancel the current password and return the system to the operator access level, go to the main menu bar and click on Operations > Clear Password.

Stop Operations

Machine activity may stop automatically for various reasons during an operation and wait for the operator to take action. There may also be times when the operator needs to stop operations during set up or in special instances.

IMPORTANT: Does your system use the **legacy control panel**? To find out, refer to [Legacy Controls & Operations](#) (pg 7.1). You'll also find the alternative/legacy content you'll need there.

Operator Activated Stops

Operations may be stopped at any time in a number of different ways. The mechanical methods require the program be restarted from the beginning, whereas the software PAUSE function allows operations to resume from the point at which they were stopped.

- Mechanical methods - pushing the Power Off or Emergency Stop buttons, or opening the safety shield - stop operations immediately.
- Software methods - clicking PAUSE or CANCEL - stop operations when the current program step has been completed.

Table 9: Consequences by Type of Stop Control

STOP CONTROL	Ends program immediately	Ends program after completing current step	Reboot required	Program must be restarted from beginning
Power Off button	X		X	
Emergency Stop button	X			X
Safety Shield	X			X
CANCEL button		X		X
PAUSE button		X		

Emergency Stops

Press the **Emergency Stop** button or open a **Safety Shield** for these results:

- The system will stop and disable all motor movement.
- A safety violation message will display.
- Any active program will abort.
- The system must be reset [refer to [Safety Violation](#) (pg 4.8)].

Press the **Power Off** button for these results:

- System power is turned off.
- Any active program will abort.
- The system must be powered back on [refer [Power On](#) (pg 4.1)].

Pause

Click PAUSE in the main button bar and the system will stop the current operation at a convenient place in the program. This is a non-destructive command, e.g. the system will not stop in the middle of a dispense of any kind. Operations can be resumed when convenient by clicking RUN in the main button bar.

Cancel

Click CANCEL in the main button bar to end a program. Occasionally a program will not abort immediately because the current operation has to execute fully. Once a program is canceled, it can be restarted only from the beginning with the normal Run procedure.

The following actions also occur when a program is canceled:

- The gantry moves to the gantry safety position.
- Stand-alone systems only: product crowders release the product.
- Conveyor systems only: lift plate descends releasing product to the conveyor rails, and conveyor operations cease when all product arrives at its destination.

System Activated Stops

The system will stop machine operations due to video equipment requirements or when system conditions reach specified limits.

Video Stops

When a system stop is related to the video equipment installed, move the camera to the requested feature and either click CLOSE to resume operations or click CANCEL to abort the program.

Passive video

The system will stop with the camera near a feature (fiducial, calibration dot, etc.) and wait for the operator to center the camera over the feature.

Active video

The system only stops and waits for operator adjustment when it cannot find a feature (fiducial, calibration dot, etc.).

Operation Limit Stops

When a system stop is related to the occurrence of a limit condition, read and respond to the information or error message displayed on the monitor. Several examples of limit conditions that can occur:

- Low level sense has been triggered.
- Maximum number of operations has been reached.
- Conveyor has timed out during product transport.

Safety Systems

Any time a safety violation occurs, a safety message displays on the monitor. The machine can be programmed to sound an audible alarm and/or display visual signals with the status light tower. Modifying status light tower operations are usually limited to access by a system Engineer.

IMPORTANT: Does your system use the **legacy control panel**? To find out, refer to [Legacy Controls & Operations](#) (pg 7.1). You'll also find the alternative/legacy content you'll need there.

Safety Violation

A safety violation displays whenever any of these conditions occur:

- a safety switch trips,
- air pressure is too low,
- the gantry attempts to move beyond its limits (due to jogging or a move or operation).

A RED message indicates an open safety switch or limit error. A YELLOW message indicates low air pressure.



To reset a safety violation:

1. Press the Emergency Stop button.
2. Clear all safety violation conditions:
 - Pull out the Emergency Stop button.
 - Close all safety shields.
 - Verify incoming air pressure meets machine specifications.
3. Click OK. The system should become operational. A safety violation message will reappear until all violation conditions are corrected.

Audible Alarm

The user controls the optional audible alarm with an on/off toggle control box in the main window.

To silence a beeping alarm

click Alarm Off to turn it off (it will turn grey) and then click it once more (it will turn red) to reactivate the alarm in case an additional alarm condition occurs.

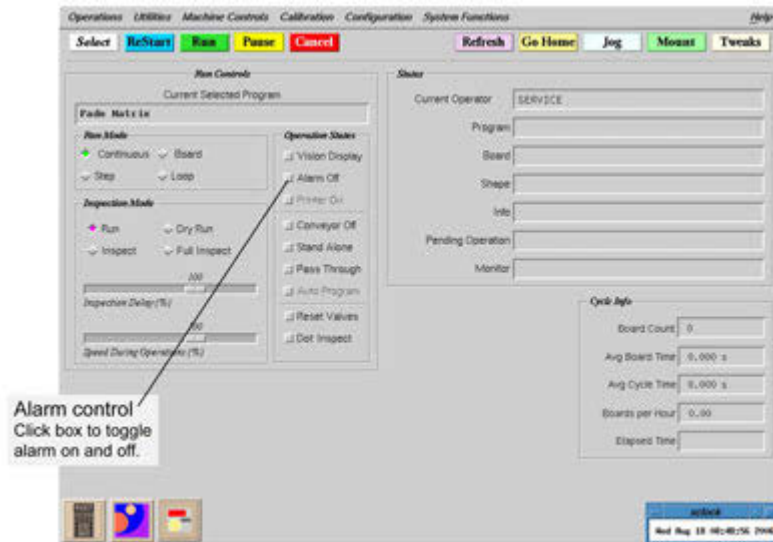

Alarm On

control box appears grey and raised. When an alarm condition occurs, alarm continues beeping until user either clicks OK on screen prompt or turns alarm off.

Alarm Off

control box appears red and recessed. The alarm will not beep when an alarm condition occurs. There are no messages that override the Alarm Off condition.

Jog Operations

Gantry movement in the X, Y, and Z axes can be directly controlled by the operator with the trackball and keyboard. This manual control over the gantry, or jogging, is typically used to position the camera and teach program coordinates, align offset points, and reposition the gantry when necessary.

How to Jog

To jog the gantry:

1. ALWAYS observe ALL jog rules:



CAUTION: Observe all jog rules or else damage to the machine may occur as a result of moving the gantry too quickly in an unintentional direction.

- **Rule #1** - Visually monitor the gantry response *EVERY TIME* you activate gantry movement.
 - **Rule #2** - Prior to using the jog feature, verify that the gantry is raised up sufficiently to clear all obstructions.
2. Click JOG in the main button bar of the main window or use the Jog window that displays automatically during various procedures.
 3. Move the gantry using the [Jog Controls](#) (pg 4.11).
 4. When the gantry is positioned where you want it, click CLOSE to exit the Jog window.

About the Jog Window

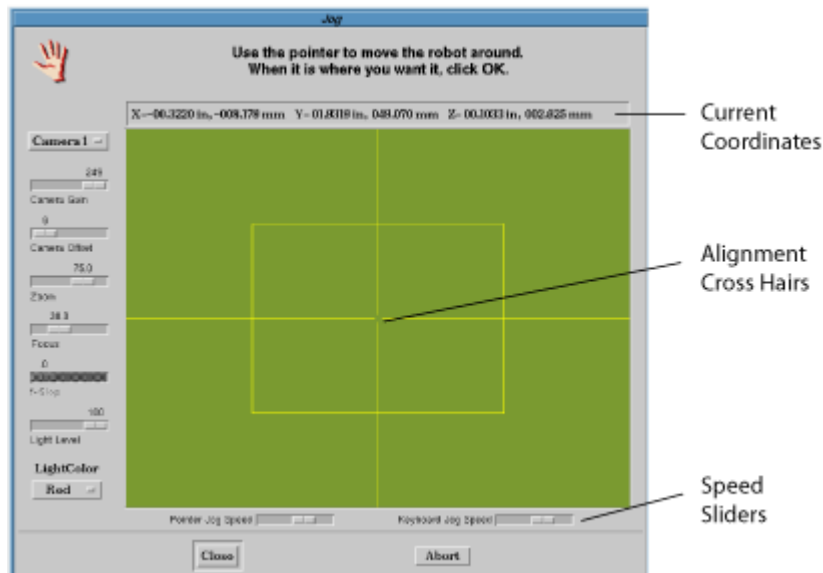

Current camera coordinates relative to the active reference point display at the top of Jog.

The **alignment cross hairs** are guides for precise alignment.

The **speed sliders** are used to change the overall operating speed of the cursor and keyboard controls.

The lens and lighting **controls located along the left side** of Jog are only available when the dispenser is equipped with the associated optional equipment. For further lens and lighting controls information, refer to *Vision Lighting & Focus* under *Programming - Keys to Success* in the *Using FLOWare Software* section of the *FLOWare Software Guide*.

Jog Controls

Gantry movement is controlled with the trackball and keyboard, and directly relates to the movement of the cursor in the Jog window.



WARNING: The gantry moves IMMEDIATELY when the jog controls are activated. Gantry motion stops immediately upon release of the jog controls.

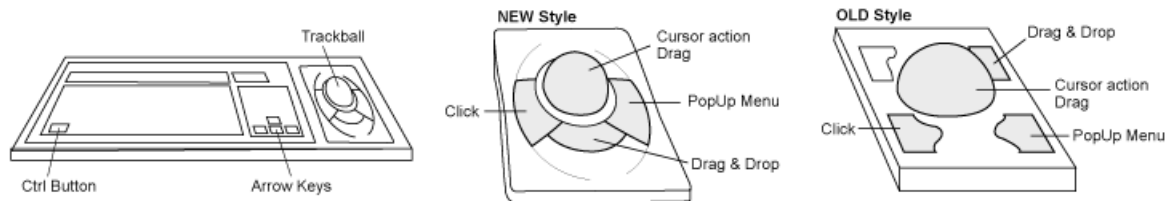

Table 10: Jog Controls - How They Work

To control:	Do this:
X-Y movement	<ol style="list-style-type: none"> 1 - Position the screen cursor in Jog. 2 - Press and hold the Click trackball button to activate jog control over the gantry, while simultaneously moving the trackball to correspond with desired direction. 3 - Release the Click trackball button when desired movement has occurred.
Z movement	<ol style="list-style-type: none"> 1 - Position the screen cursor in Jog. 2 - Press and hold the Ctrl button and the Click trackball button to activate jog control over the gantry, while simultaneously moving the trackball to correspond with desired direction. 3 - Release the Ctrl button and the Click trackball button when desired movement has occurred.
speed	<p>Speed is dynamic with the distance between the cursor and the center of the Jog cross hairs; that is, the greater the length of the line in the Jog window created by trackball action, the greater the speed of the gantry.</p> <p>To control jogging speed more precisely, use the speed sliders to change the overall operating speed of the cursor and keyboard controls.</p>
fine tuning	To move the gantry in smaller increments of motion, use the keyboard arrow keys to control gantry motion.

Run a Program

There are some basic steps involved in running a program. The order of these steps is somewhat flexible. For example, you may install the heads and set up the work area prior to selecting a program, but for the most part, the following steps illustrate the typical method of running a program:

1 - Select Program

The system always runs the currently selected program. The name of the current program is displayed in the Run Controls panel of the main window.

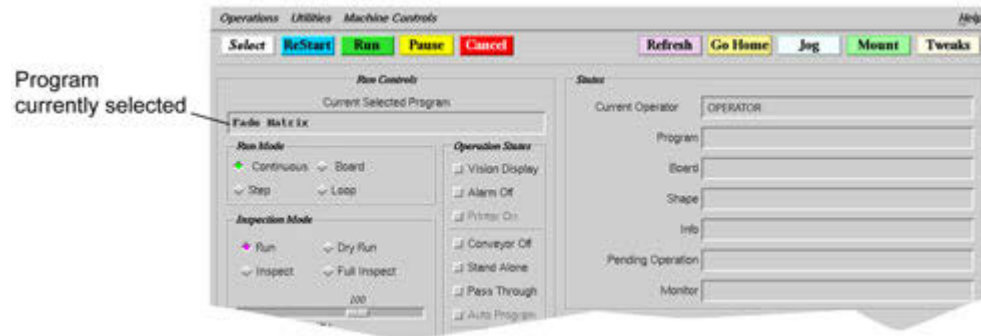

To select a program:

1. Click SELECT on the main button bar. The Select List window appears.
2. Double-click on a program name
OR
Highlight a program name and click ACCEPT.

If the program you want is not displayed, a class filter may be suppressing it. Consult your system engineer or refer to *Class Filter* in the *FLOWare Software Guide*.



2 - Select Mode & State

Operating modes and states are independent of programs, therefore, the previously selected modes and states remain as the defaults until changed by the user. Verify or change the modes and states selected as needed.

In addition to the information below, refer to [Operating Modes](#) (pg 6.17) and [Operation States](#) (pg 6.19) for details about each of the different operating modes and operation states.

Operating Mode

The operating mode determines whether the program is run or inspected and the way in which the run or inspection processes. Normally, the Inspection Mode is set to Run and the Run Mode is set to Continuous for a program run.

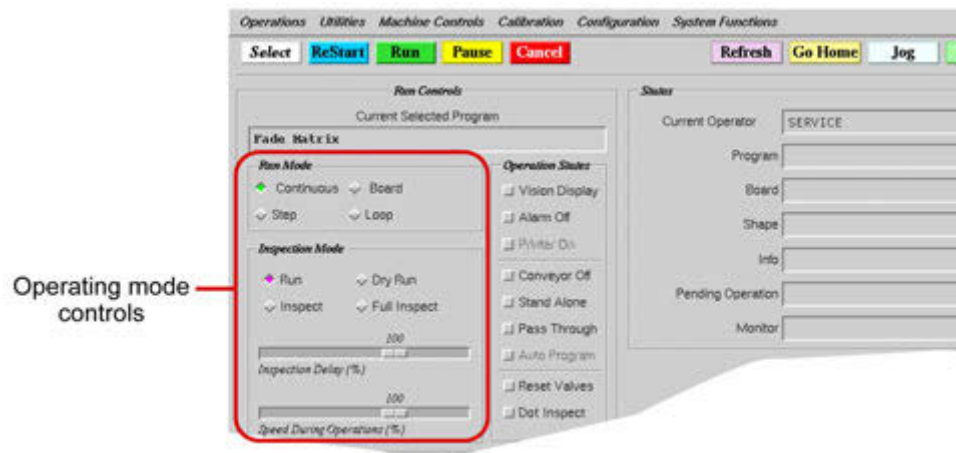

To select a normal Run operating mode:

1. Click on the Run button in the Inspection Mode panel.
2. Click on an operation pattern of Continuous, Board, Step, or Loop in the Run Mode panel.

Operation State

Operation states control conveyor and camera operations. One or more states can function at a time. To select an operation state, click on the box of each state you wish to activate.

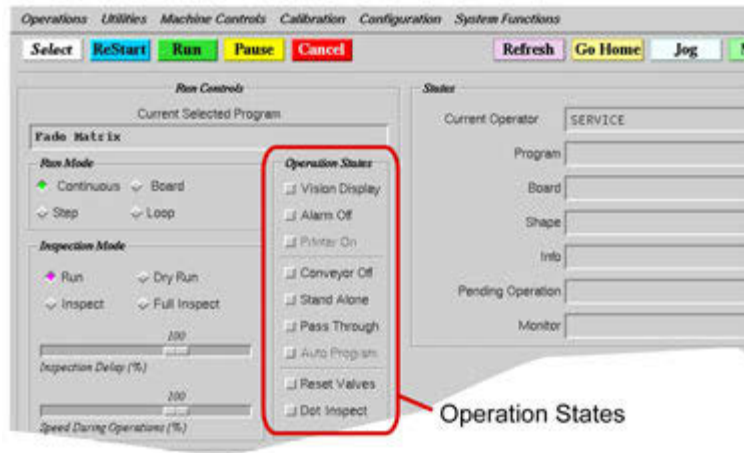

3 - Start Program

After selecting the program and confirming operating mode and operation state, a program run is ready to be initiated.

To start a program:

1. **Click RUN or RESTART** on the main button bar.

Either button starts a run. The RUN button assumes a completely new run with all external items (pallets, feeders, stand-offs) refreshed, while the RESTART button assumes feeders and pallets are in the current (but not necessarily initial) state and stand-offs are in the correct position.

EXAMPLE: The RUN button will start at the beginning of all pallets while the RESTART button will continue where the last program left off on a pallet.

2. **Mount Heads & Materials:** The gantry moves to the front of the machine and the Mounts Table displays. Mount the heads and materials specified in the window. For details about installing heads and material, refer to [Mount Heads](#) (pg 5.1) and [Mount Material](#) (pg 5.3).

EXAMPLE: According to the sample window shown here, an auger valve should be installed with shutoff in both head mount stations 1 and 2; with Hysol 4526 material on the station 1 valve; and Hysol FP4451 material on the station 2 valve.

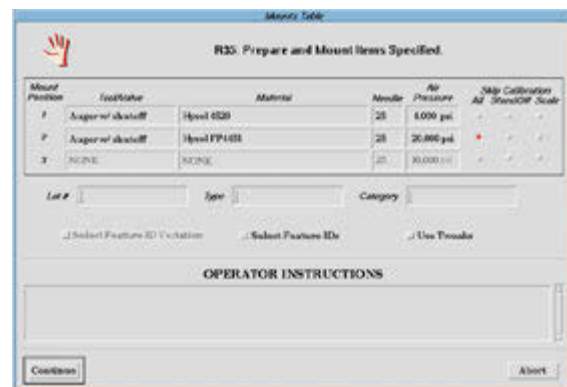

3. **Skip Calibration:** If desired, suppress the calibration procedure by clicking on the appropriate Skip Calibration buttons.

Calibration will be forced if it is stale. *Stale* refers to an adjustable value with a default of 480 minutes.

4. **Job Accounting:** If your work site uses job accounting data, fill in the Lot #, Type, and Category as needed. Lot # defaults to blank, and Type and Category default to the last values used for this program.

The Job Accounting function must be turned on, otherwise, entries are not collected; they are only retained in this window display. For further details, refer to *Management Info* under *Account Management* in the *System Management* section of the *FLOware Software Guide*.

5. **Select Feature IDs:** To execute only select program lines, click on the Select Feature IDs box and select any combination of feature IDs listed on the Feature IDs window that displays.
6. **Use Tweaks:** To use tweak values rather than program values, click on the Use Tweaks box; otherwise leave the box unchecked.
7. **Operator Instructions:** Follow any instructions in the Operator Instructions panel.

4 - Calibration

The calibration procedure will automatically calibrate each head at the calibration station in sequence by station position unless calibration is suppressed.

To initiate the calibration sequence:

1. Click CONTINUE on the Mounts Table window.
2. Proceed as directed by prompts as they display. The actions you will be prompted to take depend upon the type of head being calibrated. For details, refer to [Calibration During Program](#) (pg 6.1).

5 - Load Product

After the calibration procedure is complete, load product according to the instructions appropriate for your type of machine: stand-alone or with conveyor.

Table 11: Loading Product according to Dispenser Type

Type of Dispenser	Action required	For details, refer to:
Stand-alone	Load product after the Mount Board displays.	Load Product (pg 5.7)
With Conveyor	1 - Verify that the conveyor has been set up for the width and thickness of the product to be processed.	<i>Conveyor</i> listed under <i>SETUP</i> in the <i>Periodic Operations</i> section of the <i>Dispense System Service Guide</i> .
	2 - Load product. Automatic operations will begin.	Load Product (pg 5.7)

6 - Run Program

After loading product, the action required to resume program activity depends on the type of machine being used:

Stand-alone

To execute the program, click CONTINUE on the Mount Board prompt.

With Conveyor

No action is required. Automatic operations will begin as soon as product is loaded.



7 - After Run Cycle

After each run cycle finishes, the system tests for various conditions before the next run cycle begins and will prompt the operator to intervene when action is required.

To continue or end the program run:

1. Take the indicated steps required if prompted by the system. Various operations requiring operator intervention are listed in the following table.

Table 12: Operations Requiring Operator Intervention

Action Required	Cause	Notes
Refresh material.*	A low fluid level is detected in the material tube or reservoir.	
	Total allowed mount time is exceeded	A total mount time (typically used for temperature-sensitive material) or a total dot count or valve time has been specified.
Service head (valve or tool).*	Total On time or operation count is exceeded.	A total on time or operation count is specified, usually to prevent material from running out or to limit the number of drill operations before replacing the drill bit
Stop purge process and clean the needle.	Valve idle time is exceeded.	A valve time limit is specified. No operator action is required if a purge time is specified and an automatic needle cleaner is available.
Install empty syringe, remove filled syringe, and clean needle.	A syringe fill operation is initiated.	Requires a syringe fill station and that the associated syringe fill button be pressed.
Empty or replace purge cup.	An automatic weight calibration is initiated.	Requires a calibration scale and that the number of total operations or total board count exceeds allowed limits. No operator action is required until the weight of the material in the purge cup is close to the scale limit.

* If the operator elects to ignore the condition, the message repeats for each new product.

2. Either skip to the next step to end the program or resume processing in the manner appropriate for the type of machine being used:

Stand-alone

When the program finishes a cycle, unload the processed product, load new product, and click CONTINUE on the Mount Board prompt.

With Conveyor

When the program finishes processing available product, provide more unprocessed product to the conveyor for automatic operation.

8 - End Program

To end the active program:

1. Stop program execution with one of these methods:
 - Click ABORT on the Mount Board prompt if it is displayed, or
 - Click CANCEL on the main button bar.
2. If you intend to power off the machine, use the prescribed shutdown procedure. Refer to [Power Off](#) (pg 4.3).

Activities When Machine is Idle

The following activities can be performed as needed any time the machine is idle, i.e. powered on and fully homed, and the default access permissions are set to Operator (assuming appropriate access rights are assigned).

Summary of Available Activities

- Determine software version
- Change password
- Clock removal/retrieval
- Calculator use, removal/retrieval
- Add or read online notes
- Move the gantry (jog)
- Install/remove heads and material
- Offline material operations (purge, weigh, fill syringe)
- Use, close/restore Editor icon
- Load product
- Import/Export/Convert programs
- Print, examine, or purge accounting data
- Backup the system
- Restore a previous backup
- Install software upgrades

Activities Typically Available When Machine is Idle

Software Version

To determine the level of FLOWare software you are running, click Help > About.

Passwords

Access to various system features is controlled by passwords supplied by the person who administers the system. When the system is started, the password in effect allows minimal access (operator level) to the system. For details, refer to [Password](#) (pg 4.5).

Clock

For convenience, a clock showing the date and time is provided in the lower right corner of the main window. To remove the clock, double click the button in the upper left corner of the clock. After removal, the clock can be restored by clicking on Operations > Clock.



Calculator

For convenience, a calculator is provided as an icon in the lower left corner of the main window when the system is started.

- To use the calculator, double click on the calculator icon. Functions can be performed with the trackball or with the keyboard.
- To remove the calculator, double click the button in the upper left corner of the calculator.
- The calculator can be restored by clicking on Operations > Calculator.

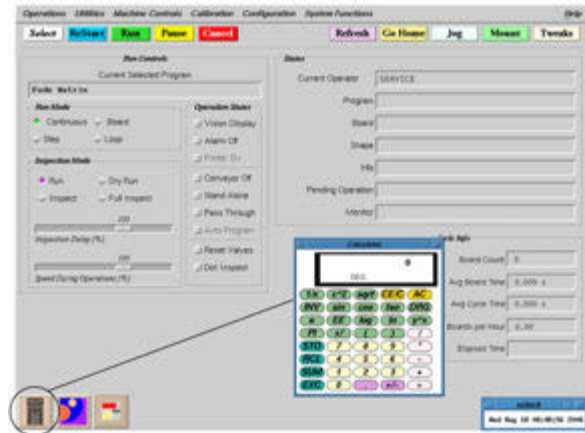

Notes

The system has a note pad facility to allow operators to leave notes for an engineer or other operators.

- To enter a note, from the main menu bar click on Utilities > Notes > Add Note.
- To read previous notes click on Utilities > Notes > View Notes.

For details, refer to [Notes](#) (pg 6.9).

Move the Gantry



JOG

When the machine is idle, the gantry can be moved by clicking JOG on the main button bar. For details, refer to [Jog Operations](#) (pg 4.10).

GO HOME

To move the gantry out of the way quickly, click on GO HOME.

REFRESH

To move the gantry to the front of the machine for access to the heads, click on REFRESH.

Heads & Materials

If you know which heads and materials are needed, they can be mounted in advance while the machine is idle. Use the REFRESH button to move the gantry to the front of the machine, then prepare the tools, valves, and materials and install them. For details, refer to [Mount Heads & Material](#) (pg 5.1).



WARNING: Some materials must be refrigerated and cannot stand idle for long periods of time or they may cure in the valve.

ADVERTISEMENT

Certaines matières doivent être réfrigérées et ne peuvent pas rester immobiles pendant des périodes prolongées sans risquer de durcir dans la valve.

ACHTUNG

Einige Materialien müssen gekühlt werden und dürfen nicht über einen längeren Zeitraum stehen. Andernfalls können sie im Ventil aushärten.

AWERTENZA

Alcuni materiali devono essere refrigerati e non possono restare inattivi per lunghi periodi di tempo altrimenti potrebbero polimerizzarsi nella valvola.

ADVERTENCIA

Se deben refrigerar algunos materiales y no pueden dejarse sin usar durante largos períodos de tiempo, puesto que pueden endurecerse en la válvula.

Material Operations

Several operations can be performed after heads and materials are mounted and the machine is idle:

- Valves may be purged manually.
- If the machine is equipped with a scale, a shot of a predefined On Time can be weighed.
- If the machine is equipped with a syringe fill station, a syringe can be filled.

Any of these functions can be performed by clicking Machine Controls > Offline Operations. For details, refer to [Offline Operations](#) (pg 6.11).

Editor



An Editor is available to examine, create, and modify programs and shapes and to alter various internal tables. When the machine starts, one instance of the Editor is provided as an icon in the lower left corner of the screen.

- To use the Editor, double click on the Editor icon. The look of the Editor icon depends on which selection (Edit Programs or Edit Shapes) is selected in the Program Editor.
- To Close Editor, double click the button in the upper left corner of the Editor.
- To Restore Editor, or to bring up a second instance of the Editor, click on Operations > Edit.

Mount Product



To mount product manually while the machine is idle, click on MOUNT.

- Conveyor systems – the lift plate rises to support product.
- Stand-alone systems – the board crowders will lock.

Import, Export, Convert

With the appropriate access rights, you can import programs from other machines and export programs for use on other machines. For details, refer to the *FLOware Software Guide*.

Utility Functions

With the appropriate access rights, you can:

- print, examine, or purge accounting information;
- back up the material on the system or restore a previous backup;
- or install software upgrades.

All other utility operations are usually limited to access by a system Engineer. Refer to the *FLOware Software Guide*.

5 Set Up Instructions

This section details procedures commonly used during system preparation such as installing and removing heads and dispense material, and loading and unloading product.

Mount Heads & Material

The heads (valves and/or tools) and materials used in the current program may be installed either while the machine is idle or when the system prompts for them early in the run process. Once you have the heads and materials mounted, the power and/or air lines for each head need to be connected to the dispenser receptacles.

Mount Heads

Perform the following procedure for each head to be used.

1. Click REFRESH on the main button bar to bring the gantry to the front of the machine or else jog the gantry until the head mount stations are close to the front of the work area.
2. Determine into which mount station you'll be mounting the head.
3. Mount the head using the following instructions applicable to the type of mounting hardware on your machine: taper-lock, ball lock, or clamp mount.

Taper-Lock Mount

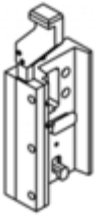

1. Press down and hold the latching lever at the top of the mount.
2. Align and engage the head with the top dowel pin of the mount.
3. Apply downward pressure to the head while releasing the latching lever.

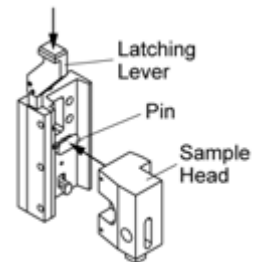

Ball Lock Mount

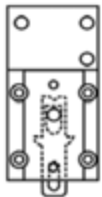

1. Press upward and hold the latching lever at the base of the mount.
2. Align the ball lock pin on the head with the ball lock on the mount. Press the head into the mount.
3. Release the latching lever.

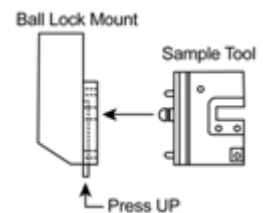

Clamp Mount

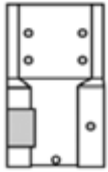

1. Using a 3/32" allen wrench, loosen the mounting bracket's clamp bar set screw in the head mount station.
2. Slide the head into the mounting bracket until it seats against the stop pin.
3. Secure the head in place by tightening the set screw.

1. Loosen set screw 2. Seat mount on pin 3. Tighten set screw

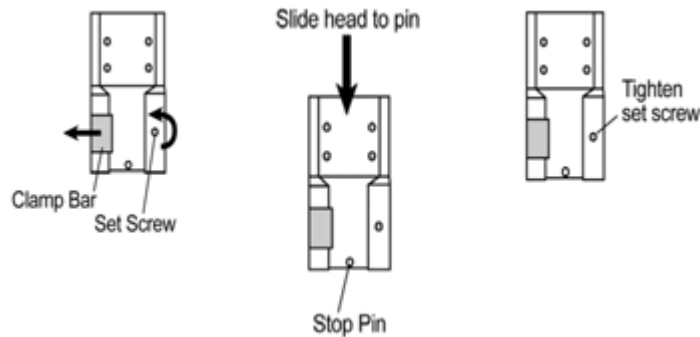

EXCEPTION: Micro-Dot Valve

Any time a Micro-Dot valve is installed, turn on the Reset Valves box to reset the valve controller. Other valve types with separate controllers may require the machine to be shut down and then powered on to reset the controller, else the system will fail to recognize the head and the head will not function.

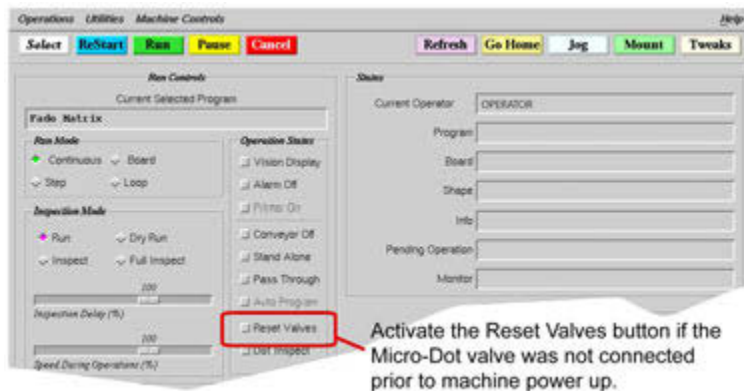

Mount Material

For each head using a dispense material, select and perform the applicable procedure

- For most dispensing valves, except the Liquid Dispense Valve or Pinch Tube Valve, perform the following [Dispense Valves](#) (pg 5.3) procedure.
- For a Liquid Dispense Valve, perform the following [Liquid Dispense Valves](#) (pg 5.3) procedure.
- For a Pinch Tube Valve, refer to the special instructions accompanying the valve.

Dispense Valves

Typically, you'll use this procedure for most dispensing valves except the Liquid Dispense Valve or the Pinch Tube Valve.

To mount a syringe of material and a needle on a dispense valve:

1. Remove the syringe tip cap.
2. Fit the syringe into either the material feed tube or the valve syringe fitting.
3. Mount a needle of appropriate size using tools if required. If Luer-Lok type needles are only finger tightened, operational vibrations could dislodge the needle.

Liquid Dispense Valves

1. Choose the syringe holder orientation applicable to the syringe diameter you are mounting.

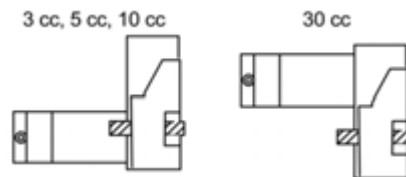

Orientation of the syringe slide is determined by the diameter of the syringe barrel.

2. If the syringe diameter is 30 cc, the same size as the syringe holder, skip to the next step.

If the syringe diameter is smaller than the syringe holder (3 cc, 5 cc, or 10 cc), slide an interchangeable syringe bushing into the syringe holder. Interchangeable syringe bushings are available in various sizes to match syringe barrel diameter.

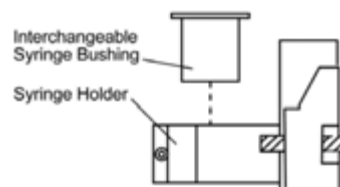

Use an interchangeable syringe bushing, as necessary, to accommodate syringe diameter.

- To achieve proper needle tip position, vertically adjust the syringe according to the type of surface sensor used on your machine, the type of machine, and the position of head mount station in which the valve is mounted - see the table below for details.

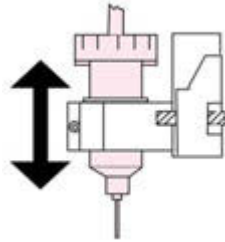

Slide syringe up/down in holder until desired needle tip position is achieved.

Table 13: Needle Tip Position Guide

Type of Surface Sensor	Machine Model	Station	Position of Needle Tip
Contact	MAX Series	All stations	FLUSH with touch probe tip
	DS Series	Station 1	1.0" (25,40 mm) BELOW touch probe tip
		Stations 2 & 3	FLUSH with touch probe tip
Non-Contact (laser)	MAX Series	All stations	0.50" (12,70 mm) BELOW bottom surface of laser
	DS Series	All stations	Not applicable

Connect to Receptacles

To connect a mounted head to the dispense system:

- Guide the lines from the mounted head toward the receptacles. DS Series only: guide the lines behind the guide plate (unless connecting lines to dedicated receptacles).
- Attach the lines from the mounted head to the appropriate receptacles based on head mount position and head receptacle requirements. For details, refer to [Receptacle Selection](#) (pg 5.5).

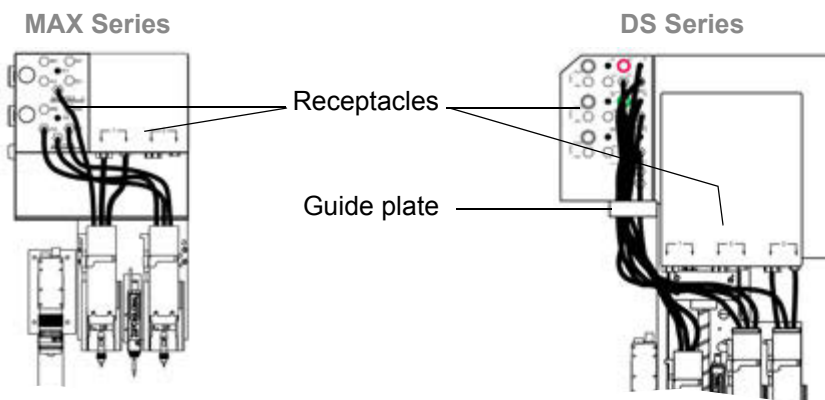

Receptacle Selection

Head receptacles are typically located in the “receptacle panel”. When needed, additional receptacles are available in the “dedicated receptacles” and “auxiliary receptacles” locations.

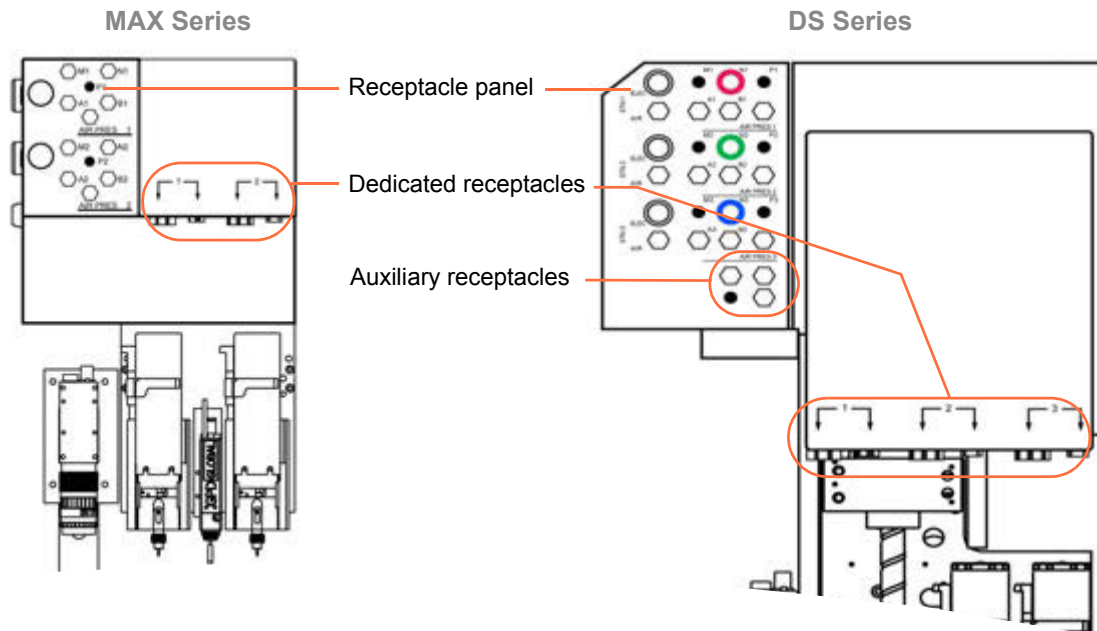

Within each location, receptacles are grouped by head mount position: Head1, Head2, Head3.

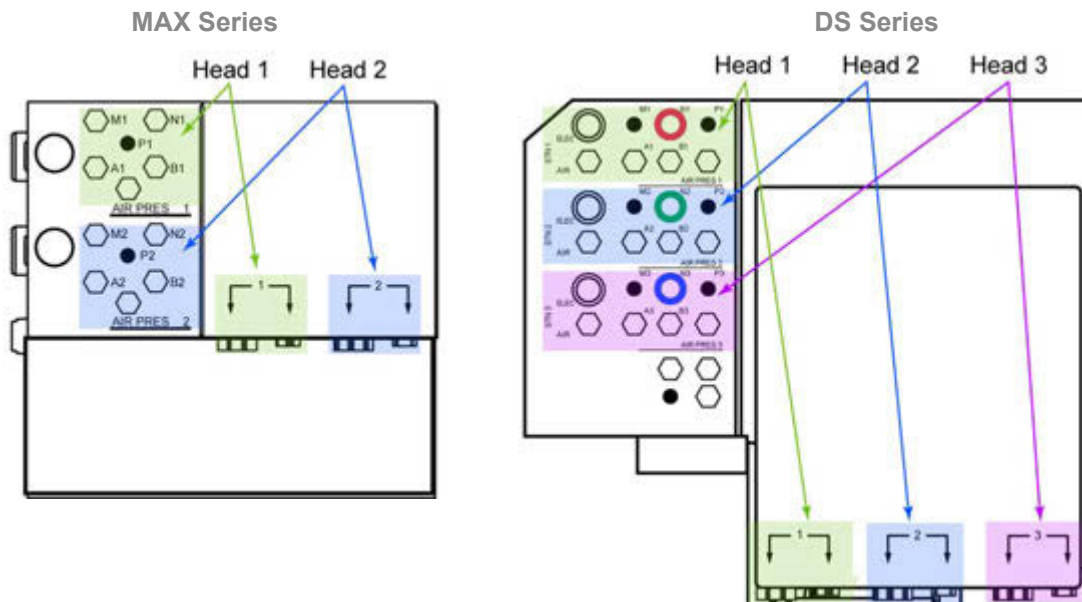

The label on each head cable and/or hose matches a receptacle label (AIR PRES, AIR, ELEC, P, N, etc.) on the machine.

Table 14: Receptacle Connections by Head Type

Head Type	Receptacle Labels									
	ELEC	AIR	M	N	P	A	B	AIR PRES	Dedicated Receptacles	Auxiliary
FPC Pump Interface				X						
Liquid Dispense								X		X
NCM5000 - on DS Series	X	X						X		
NCM5000 - on MAX Series			X					X	X	
Needle Dispense						X	X	X		
PCD3H, PCD4H, PCD4HB, PCD6HB								X	X, X	
PCD3, PCD3L, PCD4, PCD4L, PCD6								X	X	X
Piston - on DS Series	X	X						X		
Piston - on MAX Series			X					X	X	
Precision Auger								X	X, X	
Spool						X	X	X		
Syringe Mixer				X				X		
Legacy Models - no longer offered										
HyFlo								X	X, X	
LX Auger					X			X		
LX Auger with Shut-off					X	X	X	X		
Micro-Dot *								X	X, X	
MV50/400 Metering †					X	X				X
NCM8350								X		X
Pick & Place **										X
Pick/Press			X	X	X	X				
Pinch Tube						X		X		
Positive Displacement ‡					X			X		

* Also requires quick-disconnect connections to valve-specific power connector and encoder cable.

** Connects to the vacuum generator quick-disconnect located on the rear of the Z axis plate.

† Also requires two limit sensor connections.

‡ The receptacle(s) required may vary with the model of valve used.

Load Product

The means by which product is placed in the dispenser depends on whether or not the dispenser is equipped with a conveyor. When a dispenser is equipped with a conveyor, product can be loaded either automatically or manually. A stand-alone dispenser requires manual product placement.

Dispenser with Conveyor

Dispensers with a conveyor will normally load product automatically from upstream. Product is only loaded manually on these types of dispensers when in stand-alone or manual stand-alone mode. For further details, refer to [Emulate Stand-Alone or Manual Unit](#) (pg 6.20).

Stand-Alone Dispenser

To load product in a stand-alone dispenser:

1. As necessary, use the ESD grounding connection on the front of the machine.
2. Open the safety shield. A safety violation message will display.
3. Position product in the lower right hand corner of the work area fixed XY rails.

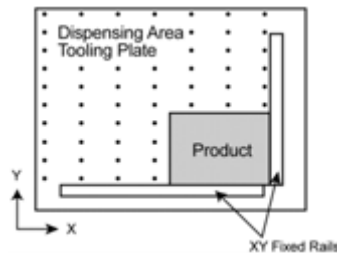

4. Position a crowder at the product edges, orienting each crowder so it meets all of the following requirements:
 - Orient crowder with its pneumatic solenoid toward product.
 - Set crowder within 0.25" (6.4 mm) of product edge.
 - Position crowder along product edge so product will be held firmly against the fixed XY rails when the solenoids are extended.
 - Align the crowder bolts over the closest tooling plate holes and tighten until snug. When processing begins, the pneumatic solenoids will automatically extend, fixing the product in place.
 - Close the safety shield and clear the safety violation message.

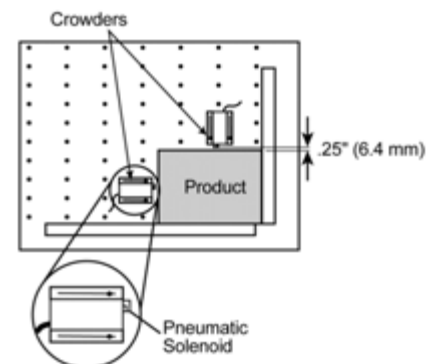

Unload Product

The means by which product is removed from the dispenser depends on whether or not the dispenser is equipped with a conveyor. When a dispenser is equipped with a conveyor, product can be removed either automatically or manually. A stand-alone dispenser system requires manual product removal.

Dispenser with Conveyor

To unload product from a dispenser with conveyor:

1. Stop the active program by clicking CANCEL on the main button bar of the main window. A delay may occur before the program terminates due to the downstream flow rate.
2. If product is present in the conveyor entry or nest positions, manually remove it from each position.

Stand-Alone Dispenser

To unload product from a stand-alone dispenser:

1. The crowders are normally open when a program completes. If they are not open, click MOUNT on the main button bar of the main window and then when the product crowders release the product, click ABORT to end the mounting sequence.
2. Manually remove product from the work area.

6 Operating Detail

This section is comprised of procedures and background information for topics that affect and support operation at the operator level.

- [Calibration During Program](#)
- [Machine Controls](#)
- [Notes](#)
- [Offline Operations](#)
- [Operating Modes](#)
- [Operation States](#)
- [Head Selection by Viscosity](#)
- [UPS Control](#)

Calibration During Program

The predominately automatic calibration process uses the calibration station to establish offsets between each head, the surface sensor, and the camera.

Prior to program execution, the system automatically prompts the operator to confirm that all displayed heads are loaded and that displayed settings have been set. After the operator confirms these actions have been taken, the calibration procedure begins for each head in sequence by mount station.

Confirm Data in Mounts Table

The Mounts Table window displays whenever a program run is started. You will need to do one of the following:

- Confirm the displayed information is correct,
- Cancel the program to make changes to the displayed information,
- Activate the skip function for any mount station that you want to be ignored during the calibration process, or
- Enter information in the Lot#, Type, and Category fields.

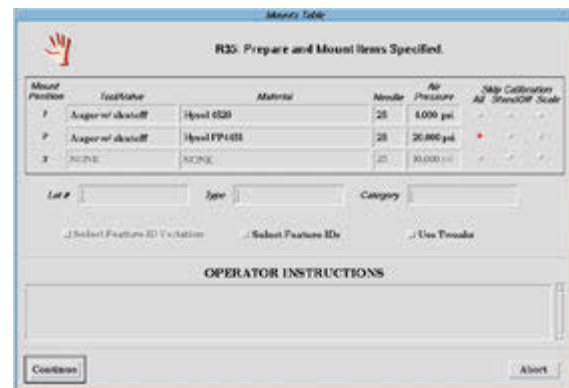

To confirm Mounts Table data:

1. Verify the items specified (Valve/Tool, Material, Needle Gauge) in the Mounts Table window are actually installed and set up on the machine and that type and size corresponds with the data displayed.
2. Verify that dispenser air pressure is set to the displayed air pressure value.

3. As applicable for each mount station, click the SKIP CALIBRATION box for the pertinent selections - that is, the selections you do not want to calibrate.

NOTE: DO NOT skip calibration if the camera has been refocused. (Changing camera focus may invalidate any existing vision patterns.)

NOTE: The system will NOT skip calibrating a mount station if the data for the head in that mount station has been changed or if the limit for time between calibrations has elapsed.

4. As applicable, enter data in the management records fields of Lot #, Type, and Category. Existing entries in Type and Category are carried forward from the prior program run, while Lot # reverts to blanks for each run. (These fields exist solely for whatever records the customer wants to keep.)
5. If present, follow the instructions displayed in the Operator Instructions panel of the Mounts Table window.
6. As applicable, click on the Select Feature IDs box to activate selective processing. Refer to *Feature ID* in the *Programming - Keys to Success* section of the *FLOware Software Guide*.
7. As applicable, click on the Use Tweaks box to activate parameter fine tuning. Refer to *Live Program Adjustment* under *Windows & Fields* in the *References* section of the *FLOware Software Guide*.
8. Click CONTINUE on the Mounts Table window to initiate the calibration sequence. The predominately automatic calibration sequence may prompt the operator to perform certain tasks. For details about the calibration sequence, refer to the following [Calibration Procedure](#) (pg 6.3).

Calibration Procedure

The calibration procedure is predominately automatic. The operator need only perform minor operations when prompted to do so. The type of operations prompted for depend on the type of head being calibrated.

The type of offset established also varies with the type of head being calibrated. For dispense valves, calibration establishes the needle height to surface sensor height offset. For cutting tools, calibration establishes the tool probe height offset. For drills, calibration establishes the drill probe to drill bit offset.

Typical Calibration Sequence

The following calibration sequence, initiated from the Mounts Table window, is typical for a dispense valve. For calibration details about other types of heads, refer to the *Calibrate* section of *Periodic Operations* in the *Dispense System Service Guide*.

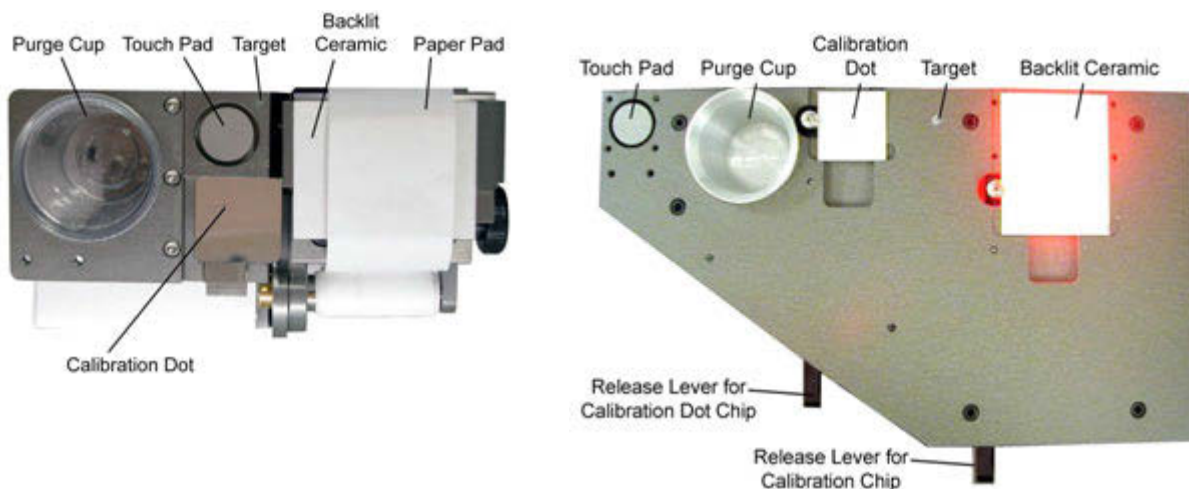

1 - Surface Sensor to Touch Pad

The surface sensor lowers automatically to the Touch Pad to establish the probe trigger point.

2 - Camera/Gantry Correlation

Automatic vision systems only - The system determines the pixel-to-encoder-count ratio by locating the Calibration Dot with the camera and moving the gantry.

3 - Surface Sensor to Ceramic/Paper Pad

The surface sensor locates the Paper Pad (or Ceramic Pad or Ceramic/Paper Pad) to establish the pad level for dispensing.

4 - Needle to Touch Pad

The head tip moves automatically to the Touch Pad to establish tip position relative to the surface sensor.

5 - Purge/Charge Valve & Prepare to Dispense

(may require 2 to 3 minutes) The dispensing valve automatically moves to the Purge Cup and the Purge prompt will display.

To purge/charge a valve and clean the needle:

A. If a preset purge time is provided, purging starts and ends with no operator intervention. Otherwise, the Purge prompt displays. Allow the purge process to continue until all purge compound has been purged and the valve discharges only processing material. When the purge process is complete, click DONE.

B. If automatic needle cleaning is in effect, needle cleaning may proceed without operator intervention. Otherwise, the Clean the Needle prompt displays:

B.1. Open the safety shield and manually wipe any excess material from the needle.

B.2. Close the safety shield and clear the safety violation condition.

B.3. Click CONTINUE on the Clean the Needle prompt.

6 - X, Y Tip Calibration

The dispensing valve needle automatically moves to the Paper Pad (or Ceramic Pad or Ceramic/Paper Pad) and dispenses an alignment dot on the paper. The type of vision system determines what action, if any, is required:

- If the machine is equipped with automatic vision, no action is generally necessary unless a manual calibration is forced in the program or the camera cannot find the dot, i.e. the dot is outside the calibration window tolerance or the dot is a bad dot.
- If the machine is equipped with passive vision or the automatic vision cannot find the dot, perform the following steps.

To establish “camera to needle alignment”:

A. Using the Jog window that displays automatically, fine tune camera alignment on the dispensed dot.

B. Click CLOSE.

7 - Dot Verification

Automatic vision systems only - If the system is configured for dot verification, a dot verification screen will display and the camera will move into position over what the system assumes is the calibration dot. The system then waits for the operator to either confirm that the proper dot has been found, retry the dispense, or abort the process.

8 - Clean the Needle

If the Clean the Needle prompt displays, click CONTINUE.

9 - Calibration of Remaining Heads

The previous calibration steps are repeated for each head in sequence by mount station until all mount stations have been calibrated. When calibration for all stations is complete, the Mount Board prompt displays.

Machine Controls

The options listed under Machine Controls allow the operator to exercise direct control over the machine.



WARNING: Although our customers often desire this feature, GPD Global takes no responsibility for its use. Direct control of features can lead to damaged equipment and can disrupt program operation if the operator activates these controls at the wrong time or in the wrong sequence.

Suggested alternative: Use the Machine Controls menu items in preference to using Custom Controls and I/O Viewer. For example, to mount a board manually, click the MOUNT button in the main menu bar, then move the lifter plate using the Lifter Up and Lifter Down options in the Machine Controls menu.



AVERTISSEMENT: Bien que nos clients souhaitent souvent avoir recours à cette fonction, GPD Global décline toute responsabilité relative à son usage. Le contrôle direct des fonctions peut occasionner un endommagement de l'équipement et peut interrompre le fonctionnement d'un programme si l'opérateur active ces commandes au mauvais moment ou dans un ordre erroné. **Solution de rechange suggérée.** Utiliser de préférence les éléments du menu des Commandes machine plutôt que les Commandes personnalisées et le Viseur d'entrée-sortie. Par exemple, pour monter une plaque manuellement, appuyer sur le bouton MONTER dans la barre de menus principale, ensuite actionner l'élévateur en utilisant les options Élévateur vers le haut et Élévateur vers le bas dans le menu des Commandes machine.



ACHTUNG! Obwohl unsere Kunden oftmals dieses Funktionsmerkmal verlangen, übernimmt GPD Global keine Verantwortung für seinen Einsatz. Die direkte Steuerung von Funktionen kann die Anlage beschädigen und den Programmbetrieb stören, wenn der Bediener diese zum falschen Zeitpunkt oder in der falschen Reihenfolge aktiviert. **Vorgeschlagene Alternative.** Benutzen Sie lieber die Menüpunkte der Maschinensteuerung anstelle der Bedienersteuerung und E/A-Betrachtungsprogramm. Wenn zum Beispiel eine Platte manuell befestigt werden soll, klicken Sie die MOUNT-Taste (BEFESTIGUNGS-Taste) auf der Hauptmenüleiste und bewegen Sie die Hebeplatte mit den Optionen „Lifter Up“ (Heber nach oben) und „Lifter down“ (Heber nach unten) im Maschinensteuerungs-Menü.



AVVERTENZA Benché i nostri clienti spesso desiderino questa caratteristica, la GPD Global non si assume responsabilità per l'uso. Il controllo diretto delle caratteristiche può comportare danni all'attrezzatura e può compromettere il funzionamento del programma se l'operatore attiva questi controlli al momento sbagliato o nella sequenza errata. **Alternativa consigliata:** usare le voci del menu Comandi della Macchina invece dell'uso di Comandi Personalizzati e Visore acceso/spento. Per esempio, per caricare un pannello manualmente, cliccare il pulsante CAR-ICA sulla barra di menu principale, quindi spostare la piastra di sollevamento usando le opzioni Sollevatore Su e Sollevatore Giù nel menu Comandi della Macchina.



ADVERTENCIA Aunque nuestros clientes frecuentemente desean esta función, GPD Global no asume la responsabilidad por su utilización. El control directo de las funciones puede provocar daños al equipo y también puede perturbar la operación del programa si el operador activa estos controles en el momento equivocado o en la secuencia equivocada. **Alternativa sugerida.** Use preferentemente los elementos del menú “Controles de la máquina” en lugar de usar los “Controles personalizados” y Visor I/O de entradas y salidas. Por ejemplo, para instalar una placa manualmente, haga clic en el botón MOUNT (MONTAJE) en la barra del menú principal, seguidamente mueva la placa elevadora utilizando las opciones de ascenso (Lifter Up) y descenso (Lifter Down) en el menú de “Controles de la máquina”.

Clear Signal

The system is capable of generating a signal to be used remotely to indicate out-of-range weight on the optional precision scale. This signal is intended to ring a bell in a location perhaps 1,000 feet from the machine and is not cleared remotely; it must be cleared by clicking on Machine Controls > Clear Signal.

IO Viewer

The IO Viewer allows the user to manipulate inputs and outputs directly. The IO Viewer is usually only available to the machine administrator or programmer. It affords a constant view of the state of any selected set of machine inputs and the ability to control any selected machine outputs. For further information, refer to *IO Viewer* in the *Appendices* section of the *FLOWare Software Guide*.

NOTE: Prior to using IO Viewer, read the warning notice on the preceding page.

Lens Adjust

Lens Adjust provides automatic camera lens adjustment for dispensers configured with ClearVu Vision. Adjust the focus controls while monitoring focus results in the live video screen that displays alongside the focus controls panel. For more details, refer to *Camera/Lens Alignment* in the *ADJUST* section of *Periodic Operations* in the *Dispense System Service Guide* for more details.

Lifter Controls

Lifter controls move the lifter plate without damaging fixtures or confusing the program. These functions may be performed when adjusting lifter pins or during other setup operations.

To use the lifter controls, either click on Machine Controls > Lifter Up or click on Machine Controls > Lifter Down. The device will be activated IMMEDIATELY.

MV50/400 Controls

Home

MV50/400 Home activates the homing of the optional MV50/400 Metering Valve plungers.

From the main menu bar, click on Machine Controls > MV50/400 Home to home the valve plungers to their upper-most position (linear stage).

Jog

MV50/400 Jog provides coarse manual control over the downward movement of the valve plungers for the optional MV50/400 Metering Valve.

From the main menu bar, click on Machine Controls > MV50/400 Jog and keep the lower left trackball button depressed until the valve plungers move the cartridge valves down as far as desired. Downward movement ceases as soon as you release the trackball button.

Offline Operations

Selecting the Offline Operations choice displays a dialog allowing the operator to manually purge a valve. If the machine is equipped with a syringe fill station or a precision scale, it also allows filling a syringe with material or weighing a shot of material independently from a program. For details, refer to [Offline Operations](#) (pg 6.11).

Set Pressure/Temp

The Set Pressure/Temp window allows the operator to set the values of pressure and temperature independently from values in the program. The operator can set these values when no program is running. The new values will override the program values once a program is running.

	1	2	3
Air Pressure	0.0 psi	0.0 psi	0.0 psi
	Program ▾	Program ▾	Program ▾
Material Temp	32 F	32 F	32 F
Needle Temp	32 F	32 F	32 F
Convey Temp	32 F	32 F	32 F

Buttons: Done, Apply

To change the pressure and temperature controls, click on Machine Controls > Set Pressure/Temp. The Set Pressure/Temperature window displays. For details about changing pressure and temperature settings and program modes, refer to *Valve Air Pressure* in the *ADJUST* section of *Periodic Operations* in the *Dispense System Service Guide*.

Tilt Adjust

Tilt Adjust provides an established operation sequence for purposes of adjusting the tilt positions of a rotation fixture (one of many mechanical fixtures GPD Global can provide). If the tilt angle or home position of this particular fixture needs to be altered, the necessary manual adjustments can be made while manually controlling fixture operations with the Tilt Adjust setup routine. Refer to *Tilt Adjust Fixture Controls* listed under *Calibration Menu* in the *Calibration* section of *3-Using FLOWare Software* in the *FLOWare Software Guide* plus any fixture-specific documentation shipped with the fixture.

View Pressure/Temp

The View Pressure/Temp Tear-Off window displays the current air pressure, needle temperature and material temperature for each head, as well as heater temperatures in the work area. This allows the operator to monitor these parameters continuously. The type of variables and number of valve positions displayed depends directly on how the machine is configured.

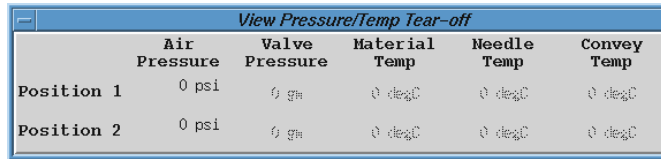

	Air Pressure	Valve Pressure	Material Temp	Needle Temp	Convey Temp
Position 1	0 psi	0 psi	0 degC	0 degC	0 degC
Position 2	0 psi	0 psi	0 degC	0 degC	0 degC

To display a tear-off window of pressure and temperature values:

1. Click on Machine Controls > View Pressure/Temp.
2. Take note of the values that apply to each active head mount station.

Notes

Notes is a text facility available to all users. This feature can be used, for example, by an operator to leave notes for the engineer, technician, or next shift.

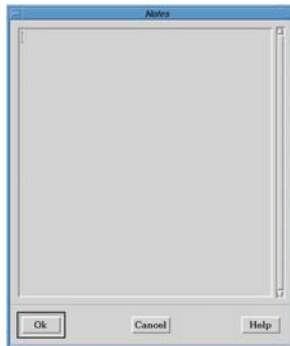

Add Notes

The current user name, date, and time will be assigned automatically to each new note. Each note may contain up to 2,000 characters.

To add a note:

1. On the main window menu bar, click on Utilities > Notes > Add Note. Notes displays.
2. Click inside the blank screen area and then type desired text.
3. Click OK to save the note or CANCEL to exit without saving it.

View Notes

Use the View Notes window to read and/or delete notes by date or operator. Notes are displayed in the right hand panel of the View Notes window. The operator who created the note and the date and time it was created are listed in the left hand panel.

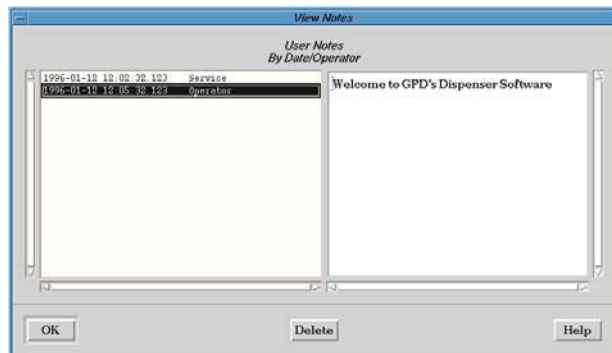

To view a note:

1. On the main window menu bar, click on Utilities > Notes > View Notes.
2. Click on the date/time/operator details of the note you wish to read. The associated note text will display in the right hand panel.
3. Click OK or CANCEL to exit.

Delete Notes

To delete a note:

1. On the main window menu bar, click on Utilities > Notes > View Notes.
2. Click on the date/time/operator details of the note you wish to delete.
3. Click DELETE to delete the note.
4. Click OK to delete or CANCEL to exit.

Offline Operations

Offline operations may be performed on the dispenser when it is not running a process. Procedures for the following offline operations are contained in this section:

- [Needle Cleaning](#)
- [Valve Purge](#)
- [Syringe Fill](#)
- [Material Weighing](#)
- [Paper Pad in Calibration Station](#)

Needle Cleaning

The machine must be equipped with and configured for a needle cleaner device in order to perform this procedure.

In addition to being cleaned as part of a program run, needles can be cleaned offline after a purge, dispense, or run. Simply select the head to be cleaned and then click the APPLY and CLEAN buttons in the same window. To clean a needle without running a program:

1. Click on Machine Controls > Offline Operations. The Off-Line Operations window displays.
2. Select the MOUNT POSITION with a needle to be cleaned.
3. Click APPLY.
4. Click CLEAN. The system locates the tip of the needle at the calibration station and then cleans the specified needle at the needle cleaner device. When needle cleaning is complete, the system moves to the safety location.

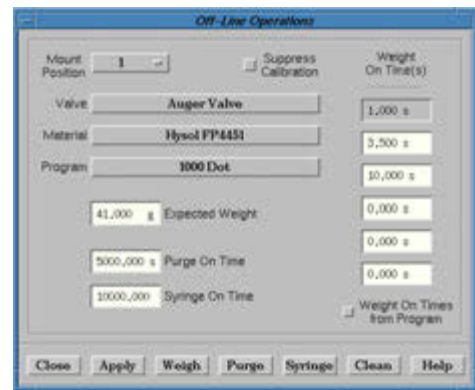

If the system displays a prompt for the operator to clean the needle rather than performing an automatic needle cleaning, then the needle cleaner feature may need to be activated. For details, refer to the *Turn Needle Cleaner On & Off* procedure in the *CLEAN Needle Online with Needle Cleaner* section of *Periodic Operations* in the *Dispense System Service Guide*.

If, after activating the needle cleaner, the expected needle cleaning process still does not occur, the needle cleaner may not be set up properly. For details, refer to the *SETUP Needle Cleaner* in the *Periodic Operations* section of the *Dispense System Service Guide*.

Valve Purge

At times, you may need to purge a valve without running a program. When a valve is first mounted, an extended purge may be required to remove air bubbles from the material. (Refer to *PURGE Valves (Online)* in the *Periodic Operations* section of the *Dispense System Service Guide*.) At the end of a job or the end of a shift, cleaning the valve with purge compound may be required.

To purge a valve without running a program:

1. Click on REFRESH to move the gantry to the front of the machine.
2. Mount the required valves and materials.
3. Click on Machine Controls > Offline Operations. The Offline Operations window displays.
4. Select the MOUNT POSITION to be purged.

If the valve or material on the screen does not agree with the valve or material mounted in the selected position:

- click on VALVE and select the proper valve, or
- click on MATERIAL and select the proper material.



NOTE: If the wrong valve or material is selected, purging may not work correctly.

5. Enter a time value in Purge On Time to control how long the valve is to purge.
6. You may click Suppress Calibration to bypass needle Z calibration.
7. Click APPLY.
8. Click PURGE. The gantry will move to the purge cup and purging will start. Purging ends when the specified purge time has elapsed or, if Purge On Time equals 0, when the operator manually stops it by clicking DONE on the Information prompt.

If the purge activity does not occur at the expected location, refer to *Shifting Purge Location* under *Material Purge Options* in the *Tips & Tricks* section of the *FLOware Software Guide*.

9. If other mounted valves are to be purged, repeat process beginning with [Step 4](#).

Syringe Fill

Some machines are equipped with a syringe fill station to allow the operator to fill a syringe with material that will be used manually.

To fill a syringe:

1. Click on REFRESH to move the gantry to the front of the machine.
2. Mount the required valves and materials.
3. Click on Machine Controls > Offline Operations.
4. Select a MOUNT POSITION containing the material desired in the syringe.

If the valve or material on the screen does not agree with the valve or material mounted in the selected position:

- click on VALVE and select the proper valve, or
- click on MATERIAL and select the proper material.

NOTE: If the wrong valve or material is selected, filling may be incorrect.

5. Enter a value for syringe fill time (if known); otherwise, enter 0.
6. You may click Suppress Calibration to bypass re-calibration unless the valve has been changed or the camera has been refocused. These actions require a calibration for proper operations to result.
7. Click APPLY.
8. Click SYRINGE. The system asks for a syringe to be mounted, moves to the syringe fill station and begins to fill the syringe. Filling ends when the specified fill time has elapsed or, if Syringe On Time equals 0, when the operator manually stops it.
9. When the fill is complete, the system moves the gantry out of the way and asks the operator to remove the filled syringe.



Material Weighing

Some machines are equipped with a precision scale to calibrate the weight of material generated by a specific on time. At times, the operator may want to determine the weight dispersed by selected on times. This capability is particularly desirable to determine initial values for program calibration.

To weigh material dispensed by entered or specific On Time(s):

1. Click on REFRESH to move the gantry to the front of the machine.
2. Mount the required valves and materials.
3. Click on Machine Controls > Offline Operations.
4. Select the valve to be used.

If the valve or material on the screen does not agree with the valve or material mounted in the selected position:

- click on VALVE and select the proper valve, or
- click on MATERIAL and select the proper material.

NOTE: If the wrong valve or material is selected, weighing may be incorrect.

5. Enter one or more On Times and an expected weight. The first On Time must be non-zero to weigh. If other On Times are non-zero, they will be treated as individual dispenses on the scale. The total of all On Times is used to generate the weighed material and to compare with the expected weight.

ALTERNATIVE: (Not implemented yet.) Specify a program by clicking on PROGRAM and then click the “Weight On Times from Program” box. Weight On Times will be filled from the first six (6) dispenses in the selected program.

6. Click on WEIGH. The scale will be zeroed, the specified amount of material dispensed and weighed, and the results displayed in a window.

Paper Pad in Calibration Station

The paper tape used in the Paper Pad module of the calibration station can be replenished by replacing the paper roll.

Required Supplies:

Paper roll (included in Calibration Station Spare Parts Kits)

- Two types of paper roll are available from GPD Global:
 - **PN 3000-0102** 2.25" wide, thermal paper roll (less absorbent)
 - **PN 3000-0101** Slightly wider than 2.25", standard absorbency paper roll
- To reorder paper rolls, note the following:
 - for machine serial numbers 2210125 and beyond, order paper roll **PN 3000-0102**
 - for machine serial numbers prior to 2210125, order paper roll **PN 3000-0101**

Compact Model

NOTE: No tools required.

To load a paper roll in the compact model of calibration station:

1. Remove the paper module from the calibration station:
 - a. Unscrew the release clamp knob (Item A).

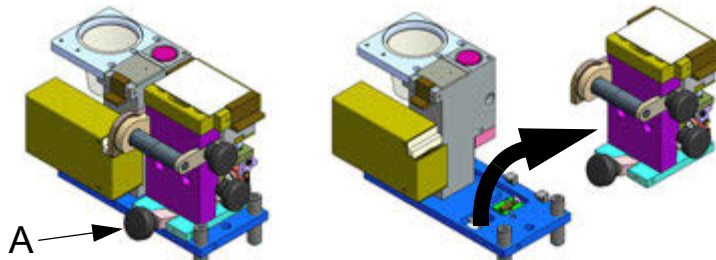

TOP VIEW

- b. Lift up slightly on the release clamp knob (Item A) and then lift the paper module up away from the calibration station.

2. To expose the paper roll shaft, unscrew and remove the paper clamp knob (Item B).

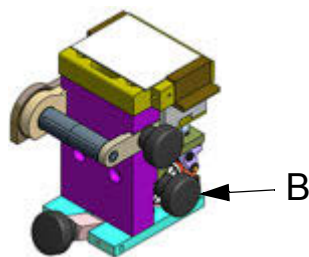

3. Slide a new paper roll over the paper roll shaft.
4. Create a tab in the loose end of the paper roll (fold over the leading 1/2" of paper).

5. Feed the paper tab over the ceramic plate (Item C) and through the slot in the paper take-up reel (Item D).

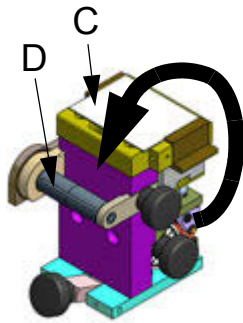

6. Turn the paper take-up reel several revolutions to lock the paper tab into the reel.
7. Screw the paper clamp knob (Item B) back into the paper roll shaft.
8. Reinstall the paper module in the calibration station:
 - a. Set the paper module in place on the calibration station with the release clamp knob (Item A) slightly lifted.
 - b. Turn the release clamp knob to lock the paper module in place.

Models prior to 2010

TOOL REQUIRED: 5/64" Allen wrench

To load a paper roll in calibration station models built prior to 2010:

1. Remove front side cover (Item B) from right-hand side of the calibration station. It is secured with a single screw (Item A).

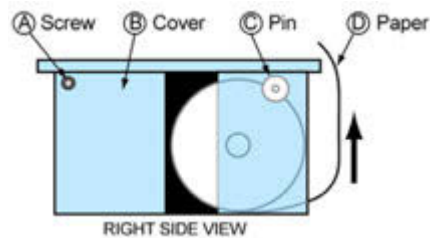

TOP VIEW

2. Unscrew the paper spool pin (Item C) that secures the paper roll in place.
3. Load a new roll of paper:
 - a. Slide a new roll of paper onto the paper spool pin inside the calibration station with the paper leader (Item D) oriented so it feeds from the bottom of the roll and toward the back of the calibration station.
 - b. Manually feed the paper leader up between the rear of the calibration station and the front of the work area.
 - c. Lift and remove the calibration station paper keeper lid above the paper roll.
 - d. Lift the idle roller up and feed the paper leader underneath it and toward the front of the calibration station.
 - e. Lower the idle roller back into place.
 - f. Return the paper keeper lid to its place.
4. Reinstall the corner cover and secure it in place.

Operating Modes

The user can select one of two operating modes: Run or Inspection. These modes determine whether the current program runs as designed or allows for inspection of the program without executing its operations.

Additionally:

- Mode settings are independent of programs.
- The default mode is the mode of the previously selected program.
- The user can select from a variety of operation patterns for each mode.



Run Mode

The run mode determines how the currently selected program will execute. Of the four choices (Continuous, Board, Step, and Loop), Continuous is generally used for normal production patterns and Loop is typically used as a demonstration or test mode.

Table 15: Run Mode Patterns

Operation Pattern	Description
Continuous	Program execution continues without pause except for required operator intervention.
Board	Processes a subboard on a panel without pause, except for required operator intervention, and then prompts the operator before processing the next panel. The operator can either continue with the next subboard or skip it.
Step	Processes a single program step and then prompts the operator to continue.
Loop	Processes the same board repeatedly without pause except for required operator intervention.

Testing with Inspection Mode

Use the inspection mode to control test modes and inspection speeds. In addition to “Run” (the normal operation pattern), an assortment of inspection modes provides dry run and inspection testing options for either processing or visually inspecting program execution.



To select Inspection Mode:

1. Click on the desired operation pattern in the Inspection Mode panel.

Table 16: Inspection Mode Patterns

Operation Pattern	Description
Run	Use for normal operations. The program executes as designed.
Inspect	Use the Inspect pattern to: <ul style="list-style-type: none"> • Show the first XY coordinate for the start of a primitive shape and show that point. • Skip all calculated points and then go to the next shape. <p>The camera (not the heads) moves to the coordinates of each program line providing visual inspection of the program. The gantry pauses for a specified time at each location to allow inspection. To adjust pause duration, use the Inspection Delay slider.</p>
Dry Run	Use the Dry Run pattern to research the following types of inquiries: <ul style="list-style-type: none"> • Are the dispense needle heights set properly in the program? • Have all program locations been taught? <p>Same as “Run” except no head operation or material dispensing occurs and no movement below the board surface (trace cutting) is made.</p>
Full Inspect	Use the Full Inspect pattern to determine the following types of inquiries: <ul style="list-style-type: none"> • Have the correct locations been taught? • Are the offset dot locations repeatable? • Will the valve/tool move to the correct location? <p>Same as “Inspect” except the camera moves along path intended for valve/tool, showing all calculated points. To adjust speed, use the Speed During Operations slider.</p>

2. As needed, use the slider bars in the Inspection Mode panel to set operation parameters.

Table 17: Slider Bar Operations

Operation Parameter	Description
Inspection Delay	The length of time the camera will wait over a coordinate.
Speed During Operations	The speed at which the camera moves over moves, fills, lines, and arcs during a Full Inspect. This is a relative speed, either slower or faster than the current setting.

Operation States

Operation States control conveyor and camera operations. Operation states are independent of program modes, but like program modes, the previously selected state is the default state, e.g. operation states are independent of programs. One or more states can function at a time. Click on the box of each state you wish to activate.

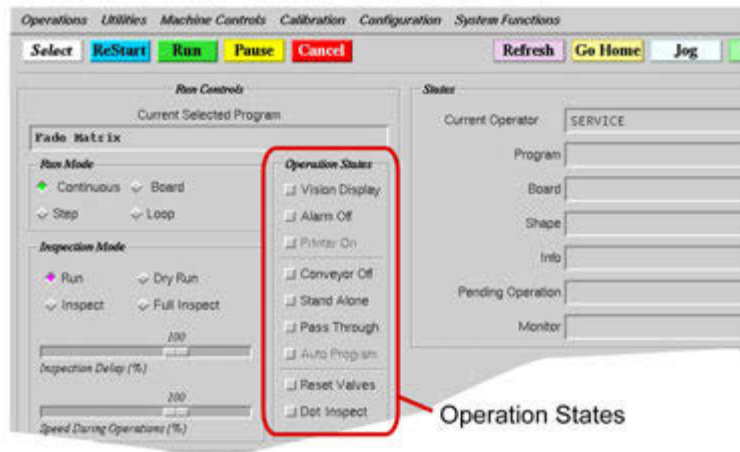

Table 18: Operation States

Operation State	Description
Vision Display	Displays camera image whenever the camera is located over a significant feature, enabling you to see what the camera sees.
Alarm Off	Prevents the audible alarm from functioning.
Printer On	Controls printer attached to the dispenser parallel port. Various print controls throughout the system (such as Print Scale Values) can be set to print and then globally controlled with Printer On.
Conveyor Off	Conveyor belt turns on briefly to seat board against nest stop pin, making this a convenient conveyor state control when developing or testing a program.
Stand-Alone	Conveyor ignores upstream and downstream signals, requiring manual product placement and removal, making this a convenient conveyor state control when developing or testing a program.
Pass Through	Conveyor passes all product through the dispenser without processing. Use this in an inline environment when a product requires no functions from the dispenser, e.g., when dispensing is not needed but you want to move boards from the upstream unit to the downstream unit.
Auto Program	A device outside the dispenser (such as a matrix reader) scans information (such as bar code) from incoming product and dictates various instructions to the dispenser (such as what program to run, how many boards to run before the next program, etc.).
Reset Valves	Resets the valve controller of a Micro-Dot valve, causing the system to recognize the head in cases where the valve is installed on the system after the system has been powered on.
Dot Inspect	If Dot Inspect is set up properly, this button enables inspection of selected dispensed dots as programmed by the engineer.

Emulate Stand-Alone or Manual Unit

A conveyor unit can be made to emulate a stand-alone conveyor unit or a manual (stand-alone) unit.



Stand-Alone Conveyor

A conveyor unit can be made to emulate a stand-alone conveyor unit by bypassing the SMEMA controls:

1. Install SMEMA plugs in the SMEMA connector ports (rear control panel).
2. Click the Stand Alone operation state box so it is turned ON. The conveyor will function normally except it will not communicate with upstream or downstream units.
3. Manually load product in the conveyor entry area and unload it from conveyor exit area.
4. To return to normal conveyor operations, remove the SMEMA plugs, and click the Stand-Alone box to turn it OFF.

Manual Unit (no conveyor)

Turn the conveyor belt off to make a conveyor unit emulate a manual (stand-alone) unit with no conveyor:

1. Click the operation state box next to both Conveyor Off and Stand-Alone. Both boxes must be turned ON. The conveyor will cease to function.
2. Manually load and unload product from the dispense nest area.
3. To return to normal conveyor operations, click the Conveyor Off and Stand-Alone boxes again to turn them OFF.

Pass Through State

Use the pass through state to inhibit all machine processes except that of passing product through the machine on the conveyor. The pass through state controls the program rather than the machine; you can select and activate a program and the machine will still look for board information but will not act on it. The board will not be processed but the machine will read SMEMA signals and operate conveyor width, conveyor pins, board width, and stop pin timing.

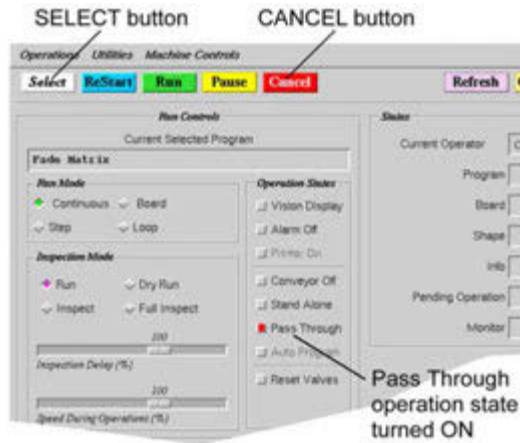

To turn ON the pass through state:

1. Click SELECT and select a program.
2. Click the Pass Through operation state box so it is turned ON.
3. Click RUN in the main button bar.

To turn OFF the pass through state:

1. In the main button bar, click CANCEL.
2. Click the Pass Through operation state box so it is turned OFF.

Head Selection by Viscosity

Use the following chart as a guide to selecting the valve best suited for the viscosity of the material you plan to dispense.

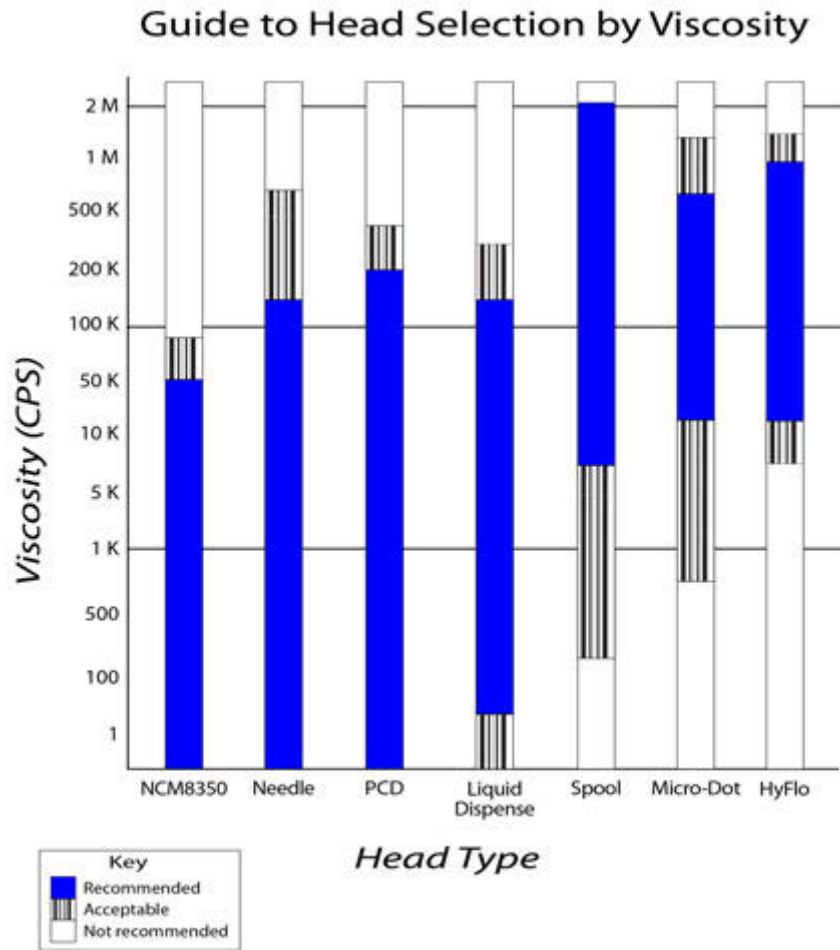

UPS Control

The optional UPS (uninterrupted power supply) battery backup feature provides full load power to the dispenser for a period of time allowing the dispenser to finish the part currently in process.

For startup and shutdown sequence details and other pertinent information about the UPS, refer to GPD Global document *UPS User Guide* (PN 22100145M).

7 References

Legacy Controls & Operations

This section includes all content related to the legacy Emergency Stop and Power Off controls previously located on the front control panel of the dispense system.

Which Control Panel Does My System Use?

Use this chart to determine which version of controls your system uses:

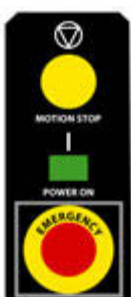
Which front panel is on your system?	 <p>CURRENT</p>	<p>This is the current version. It uses these controls:</p> <ul style="list-style-type: none"> • Emergency Stop • Power On • Power Off <p>Ignore this <i>Legacy Controls & Operations</i> section.</p>
	 <p>LEGACY</p>	<p>This is the legacy version. It uses these controls:</p> <ul style="list-style-type: none"> • Motion Stop • Power On • Emergency Stop <p>Use this <i>Legacy Controls & Operations</i> section when directed here at pertinent points in this document.</p>

As of June 2017, these hardware and terminology changes went into effect:

- *Emergency Stop was replaced with Power Off.*
- *Motion Stop was replaced with Emergency Stop.*

Legacy Contents

- [Controls](#) (pg 7.2)
- [Power On](#) (pg 7.4)
- [Power Off](#) (pg 7.4)
- [Stop Operations](#) (pg 7.6)
- [Safety Systems](#) (pg 7.8)

Controls

This section identifies and describes the location and purpose of each mechanical control present on the machine. Included are the controls that allow you to turn machine power on and off, stop and disable all motor movement, plus temperature controllers and head dispensing controls.

Power On & Off

The controls used for normal power on/off operations are located on the front of the machine:

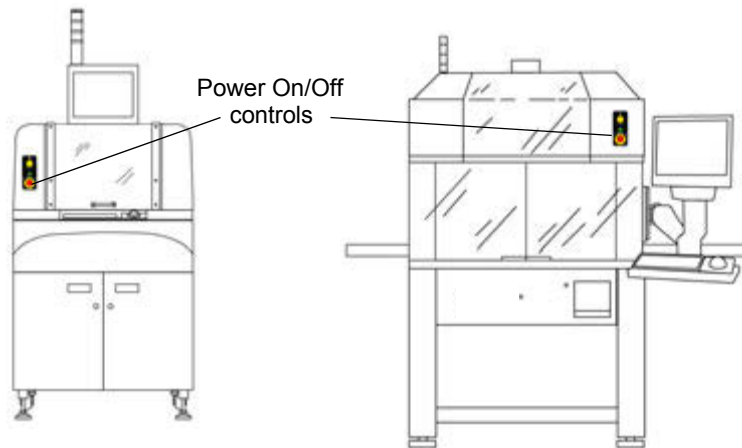

For normal power on/off operations, use the following designated switches:

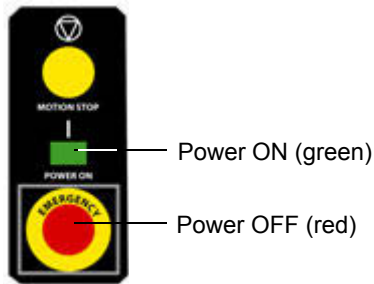

To disconnect all power to the machine, turn off the main power switch on the rear panel.

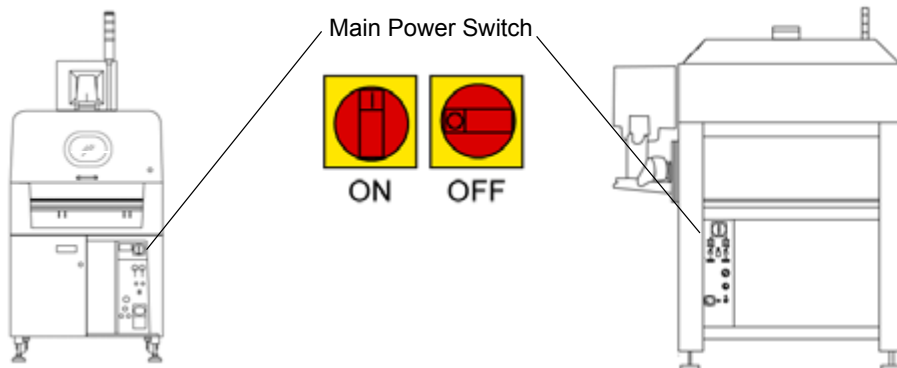

DS SERIES ONLY - OLD STYLE

The location of the controls on old style DS Series machines may differ from that mentioned in the previous section:

Emergency Stop / Motion Stop

Depending on customer requirements, older style DS Series machines might be equipped with either a red Emergency Stop button or a yellow Motion Stop button. The same front hood location is used for both buttons.

Power On / Off

The Main Power switch on older style DS Series machines is used both for normal power on/off operations and for disconnecting all power to the machine.

Emergency Stop

Pressing the Emergency Stop button stops all machine movement and shuts off the power. Use of the Emergency Stop requires that you reboot the machine before operations can be resumed.

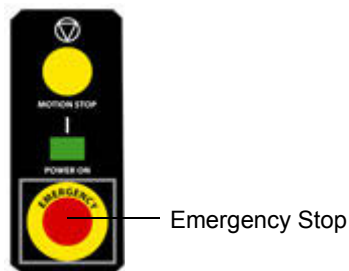

Motion Stop

Press the Motion Stop switch to stop and disable all motor movement. Using the Motion Stop button has the same result as tripping the safety interlock circuit - a safety violation message will display and any active program will abort.

Use of the Motion Stop button aborts any active program, and a machine reboot is unnecessary.

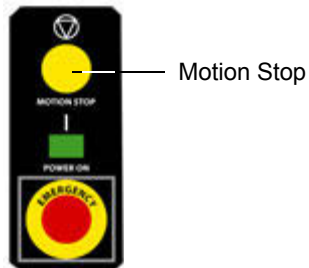

SOFTWARE ALTERNATIVE

Instead of using the Motion Stop button, you may use the PAUSE and RESUME software buttons located on the main button bar of the main window. This serves to pause and then resume operations where they left off without aborting the program.

Power On

To power on the machine:

1. Read all safety and operating instructions prior to operating the machine.
2. Verify the red Emergency Stop button is pulled out.
3. Turn on the machine by pressing the green Power On switch. The system will prompt you to home the XYZ gantry when you turn on the power and the booting process has finished. The system must complete the homing sequence before other operations are possible. Refer to [Homing the System](#) (pg 4.2).

Power Off

Before powering off the machine, end any active program and perform a proper shutdown described in the following procedure:

Prepare for Shutdown

Before you can perform the shutdown procedure, you must end any active program. It is also recommended that you unload all product from the dispense area and remove and clean the heads.

To prepare for shutdown:

1. Stop program execution with one of these methods:
 - If the Mount Board prompt is displayed, click ABORT, or
 - Click CANCEL on the main button bar.
2. After the program has ended, remove all product from the dispense area. For details, refer to [Unload Product](#) (pg 5.8).
3. Unload all heads (valves and tools):
 - a. Click REFRESH on the main button bar to move the gantry to the front of the machine where you can access the heads.
 - b. Remove the heads. For details, refer to [Mount Heads](#) (pg 5.1).
 - c. Clean the heads. For details, refer to head cleaning instructions detailed in *Valves* under *CLEAN* in the *Periodic Operations* section of the *Dispense System Service Guide*.

Shutdown

The machine can be left powered on as long as the safety system has not been bypassed, however, GPD Global recommends that you power off equipment when it is not in use.

To shutdown and power off the machine:

1. Perform the [Prepare for Shutdown](#) (pg 7.4) procedure.
2. From the main menu bar, click on Operations > Shutdown System. A shutdown verification prompt displays.
3. Click YES to shutdown the system or CANCEL to abort the shutdown. Wait until a System Stopped prompt displays.
4. Power off the machine by pressing the red Emergency Stop button.
5. Perform the [Lock-Out](#) (pg 7.5) procedure.

Energy Isolation Procedures

Lock-Out



To ensure energy isolation, lock-out the equipment:

1. Turn off customer-supplied Lock-Out switch.
2. Turn off main power switch.
3. Install a lock or tag per your facility energy isolation procedures.
4. Test if system will start by pressing the Power On switch.
5. Test volt meter on known voltage source:
 - Test for presence of electrical power at TB1 and TB2 or at EMI Filter inlet L1 or L2.
 - Reconfirm volt meter on known voltage source.

Release Equipment from Lock-Out



To release equipment from customer-supplied Lock-Out switch:

1. Remove all tools, parts, and materials from the system.
2. Verify any and all work to ensure proper installation, polarity, connection.
3. Close all doors, covers, and shields.
4. Using facility-specific procedures, remove customer-supplied locks and/or tags.
5. Pull out the Emergency Stop button.
6. Ensure the power cord is connected.
7. Turn on main power switch, watching for electrical or other failure.
8. Follow the [Power On](#) (pg 7.4) procedure.

Stop Operations

Machine activity may stop automatically for various reasons during an operation and wait for the operator to take action. There may also be times when the operator needs to stop operations during set up or in special instances.

Operator Activated Stops

Operations may be stopped at any time in a number of different ways. The mechanical methods require the program be restarted from the beginning, whereas the software PAUSE function allows operations to resume from the point at which they were stopped.

- Mechanical methods - pushing the Emergency Stop or Motion Stop buttons, or opening the safety shield - stop operations immediately.
- Software methods - clicking PAUSE or CANCEL - stop operations when the current program step has been completed.

Table 19: Consequences by Type of Stop Control

STOP CONTROL	Ends program immediately	Ends program after completing current step	Reboot required	Program must be restarted from beginning
Emergency Stop button	X		X	
Motion Stop button	X			X
Safety Shield	X			X
CANCEL button		X		X
PAUSE button		X		

Emergency Stops

Press the **Emergency Stop** button for these results:

- System power is turned off.
- Any active program will abort.
- The system must be powered back on [refer to [Power On](#) (pg 7.4)].

Press the **Motion Stop** button or open a **Safety Shield** for these results:

- The system will stop and disable all motor movement.
- A safety violation message will display.
- Any active program will abort.
- The system must be reset [refer to [Safety Violation](#) (pg 7.8)].

Pause

Click PAUSE in the main button bar and the system will stop the current operation at a convenient place in the program. This is a non-destructive command, e.g. the system will not stop in the middle of a dispense of any kind. Operations can be resumed when convenient by clicking RUN in the main button bar.

Cancel

Click CANCEL in the main button bar to end a program. Occasionally a program will not abort immediately because the current operation has to execute fully. Once a program is canceled, it can be restarted only from the beginning with the normal Run procedure.

The following actions also occur when a program is canceled:

- The gantry moves to the gantry safety position.
- Stand-alone systems only: product crowders release the product.
- Conveyor systems only: lift plate descends releasing product to the conveyor rails, and conveyor operations cease when all product arrives at its destination.

System Activated Stops

The system will stop machine operations due to video equipment requirements or when system conditions reach specified limits.

Video Stops

When a system stop is related to the video equipment installed, move the camera to the requested feature and either click CLOSE to resume operations or click CANCEL to abort the program.

Passive video

The system will stop with the camera near a feature (fiducial, calibration dot, etc.) and wait for the operator to center the camera over the feature.

Active video

The system only stops and waits for operator adjustment when it cannot find a feature (fiducial, calibration dot, etc.).

Operation Limit Stops

When a system stop is related to the occurrence of a limit condition, read and respond to the information or error message displayed on the monitor. Several examples of limit conditions that can occur:

- Low level sense has been triggered.
- Maximum number of operations has been reached.
- Conveyor has timed out during product transport.

Safety Systems

Any time a safety violation occurs, a safety message displays on the monitor. The machine can be programmed to sound an audible alarm and/or display visual signals with the status light tower. Modifying status light tower operations are usually limited to access by a system Engineer.

Safety Violation

A safety violation displays whenever any of these conditions occur:

- a safety switch trips,
- air pressure is too low,
- the gantry attempts to move beyond its limits (due to jogging or a move or operation).

A RED message indicates an open safety switch or limit error. A YELLOW message indicates low air pressure.



To reset a safety violation:

1. Press the Motion Stop button.
2. Clear all safety violation conditions:
 - Pull out the Motion Stop button.
 - Close all safety shields.
 - Verify incoming air pressure meets machine specifications.
3. Click OK. The system should become operational. A safety violation message will reappear until all violation conditions are corrected.

Audible Alarm

The user controls the optional audible alarm with an on/off toggle control box in the main window.

To silence a beeping alarm

click Alarm Off to turn it off (it will turn grey) and then click it once more (it will turn red) to reactivate the alarm in case an additional alarm condition occurs.

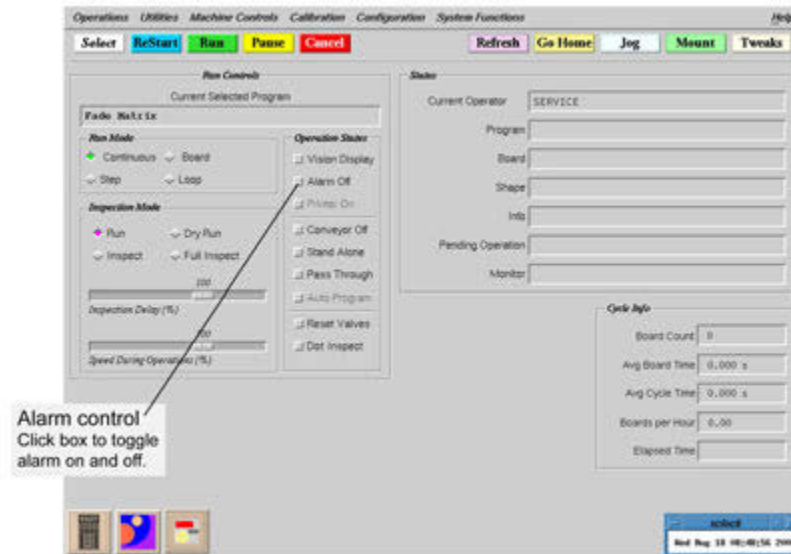

Alarm On

control box appears grey and raised. When an alarm condition occurs, alarm continues beeping until user either clicks OK on screen prompt or turns alarm off.

Alarm Off

control box appears red and recessed. The alarm will not beep when an alarm condition occurs. There are no messages that override the Alarm Off condition.

Index

A

Access Rights, *see* Password
Accounting 4.15
Alarm 3.9, 4.9, 7.9
 Off 6.19
 silence 4.9, 7.9

C

Calculator 4.19
Calibration 6.2
 backlit ceramic chip 3.17
 Dot 3.17, 6.3
 During Program 6.1
 Impression Pad 3.18
 needle 6.4
 Paper Pad, replacing 6.15
 procedure 4.15, 6.3
 Sequence 6.3
 Skip 4.15
 stale 4.15
 Standoff Pad 3.18
 Station 2.4, 3.17
 Target 3.17
Camera 2.3
 also see Vision
 coordinates 4.10
 correlating to gantry 6.3
 Fixed Video 3.14
 Lens 3.14
 Lens Adjust 6.6
 Lens, Programmable 3.14
Category 6.1
Clear Signal 6.6
ClearVu Vision 3.14
Clock 4.18
Computer 2.6, 3.10
Configuration
 see Conveyor
 see Stand-Alone
Contact Surface Sensor 3.15
Controls 2.5
 Emergency Stop 3.6, 7.3
 Go Home 4.19
 Jog 4.11, 4.19
 Legacy Controls & Operations 7.1
 Machine 6.5
 Motion Stop 3.6, 7.3

 Power On & Off 3.5, 7.2
 Refresh 4.19
 Temperature 3.7
Conventions 1.2
Convert 4.22
Conveyor
 Emulate Stand-Alone 6.20
 load product 4.15, 5.7
 machine, operating cycle 2.1
 Off 6.19
 Pass Through 6.19, 6.21
 run program 4.16
 unload product 5.8
 Work Area 2.2, 3.11
crowders 3.12, 5.7, 5.8
Cursor 3.2

D

Data Transfer Utilities 3.10
Dispense area 3.11
Dot
 Inspect 6.19
 Verification 6.4
DS Series 1.1, 3.6, 7.3

E

Emergency Stop 3.6, 4.6, 7.3, 7.6
 DS Series only 3.6, 7.3
ESD grounding connection 3.1
Export 4.22

F

Feature ID 4.15
field entry 3.4
FLOware Control Software 2.5
 version 4.18
fluid level 4.16

G

Gantry 2.3
 also see Head Mount Stations
 also see Jog
 correlating to camera 6.3
 Homing 4.2
 moving 4.19
 Refresh 4.19
 speed 4.11, 6.18

H

Hard Drive 3.10

Head

also see Receptacles

Mount 4.14, 4.20, 5.1

Mount Stations 2.3, 3.13

Select by Viscosity 6.22

servicing 4.16

Homing 4.2

MV50/400 6.6

I

Import 4.22

Inspection

Delay 6.18

mode 6.18

IO Viewer 6.6

J

Job Accounting 4.15

Jog 4.10, 4.19

Controls 4.11

MV50/400 6.6

K

Keyboard 2.5, 3.3

Accelerator keys 3.3

Arrow keys 3.3

Tab key 3.3

L

Laser Surface Sensor 3.16

Lens, *see Camera*

Lifter

Controls 6.6

plate 3.11

Light Tower 3.9

Lighting 2.4

Limit Stops 4.7, 7.7

Load Product 4.15, 5.7

Lot# 6.1

M

Machine Controls 6.5

Manual Unit 6.20

Material

Mount 4.14, 4.20, 5.3

Operations 4.20

Refresh 4.16

Weighing 6.14

matrix reader 6.19

MAX Series 1.1

Micro-Dot Valve

mounting 5.2

Reset 6.19

Mode

Inspection 4.13, 6.18

Operating 4.13, 6.17

Run 4.13, 6.17

select 4.13

Monitor 2.5, 3.7

Motion Stop 3.6, 4.6, 7.3, 7.6

Mount

Dispense Valves 5.3

Head 3.13, 5.1

Liquid Dispense Valve 5.3

Material 4.14, 5.3

Micro-Dot Valve 5.2

Product 4.21

Taper-Lock 5.1

Mounts Table 6.1

MV50/400 Controls 6.6

N

needle

calibration 3.17, 6.4

clean during calibration 6.4

Cleaning 6.11

rigid, standoff 3.18

to Touch Pad 6.3

Notes 4.19, 6.9

O

Offline Operations 6.7, 6.11

Operations

also see Mode

Basic 4.1

Calculator 4.19

Clear Password 4.5

Clock 4.18

Detail 6.1

Enter Password 4.5

Jog 4.10

Material 4.20

Notes 4.19, 6.9

Offline 6.7, 6.11

State 4.14

Stop 4.6, 7.6

Theory of 2.1

Operator

Instructions 4.15

Station 2.5

P

- Paper Pad 3.17, 6.15
- Pass Through 6.21
- Password 4.5, 4.18
- Pause 4.6, 7.6
- Power
 - DS Series only 3.6, 7.3
 - Off 3.5, 4.3, 7.2, 7.4
 - On 3.5, 4.1, 7.2, 7.4
 - Shutdown 4.3, 7.4
- Printer On 6.19
- Program
 - Auto state 6.19
 - Calibration 4.15, 6.1
 - Cancel 4.7, 7.7
 - Continue 4.16
 - Convert 4.22
 - dry run 6.18
 - End 4.17
 - Export 4.22
 - Import 4.22
 - inspection 6.18
 - Load Product 4.15
 - Restart 4.14
 - Run 4.12, 4.16
 - Select 4.12
 - Start 4.14
- Purge
 - cup 3.17, 6.3
 - stop 4.16
 - valve 6.3, 6.12

R

- Reboot required 4.6, 7.6
- Receptacles 3.13
 - Connecting 5.4
- Run
 - button 4.14
 - Controls panel 4.12
 - Dry 6.18
 - Program 4.12, 4.16

S

- Safety
 - Alarm 3.9, 4.9, 7.9
 - Notices 3.viii
 - Shields 3.8, 4.6, 7.6
 - Systems 2.6, 3.8, 4.8, 7.8
 - Violation 4.8, 7.8
- sensor, see Surface Sensor
- Set Pressure/Temp 6.7

- Set Up 5.1
- Shutdown 4.3, 7.4
- Skip 6.2
- Software, see *FLOware Control Software*
- Stand-Alone
 - Emulate 6.20
 - load product 4.15, 5.7
 - machine, operating cycle 2.1
 - run program 4.16
 - state 6.19
 - unload product 5.8
 - work area 2.2, 3.12
- States
 - Operation 4.14, 6.19
 - Pass Through 6.21
 - Select 4.13
- Station
 - see *Calibration Station*
 - see *Head Mount Stations*
- Status Light Tower 3.9
- Stop
 - also see *Emergency Stop*
 - also see *Motion Stop*
 - Operator Activated 4.6, 7.6
 - purge 4.16
 - System Activated 4.7, 7.7
- Surface Sensor 2.4, 3.15, 6.3
- Syringe Fill 6.13

T

- Taper-Lock Mount 5.1
- Target 3.17
- Temperature
 - Control 3.7
 - View 6.8
- Text Entry 3.4
- Theory of Operation 2.1
- Tilt Adjust 6.7
- Trackball 2.5, 3.2
- Tweaks 4.15
- Type 6.1

U

- UPS Control 6.23
- USB Port 3.10

V

- Valve
 - also see *Micro-Dot*
 - Dispense 5.3
 - Liquid Dispense 5.3
 - purge 6.12

Video Stops 4.7, 7.7

View

Notes 6.9

Pressure/Temp 6.8

violation, safety 3.8, 4.8, 7.8

viscosity 6.22

Vision 2.3

also see Camera

calibration 3.17

ClearVu 3.14

Display 6.19

Dot Verification 6.4

Lighting 2.4

Systems 3.14

W

Weighing Material 6.14

windows

Editor 4.21

Jog 4.10

main 4.2

Mounts Table 6.1

Notes 6.9

Off-Line Operations 6.11

Select List 4.12

Set Pressure/Temp 6.7

View Notes 6.9

View Pressure/Temp 6.8

Work Area 2.2, 3.11

Conveyor models 3.11

Lighting 2.4

load product in Stand-Alone 5.7

Stand-Alone models 3.12

X

XYZ, *see Gantry*

Z

Zoom, programmable 3.14