

Embedded Infrared Heater User Guide

Version 1.0
July 1, 2020
Part No. 22140091

for use with:

Control Software (PN 2050-0104)
and
Embedded Infrared Heater User Guide (PN 22151020-0001)

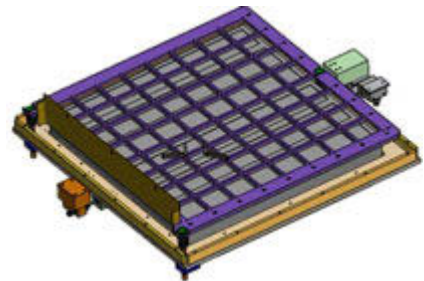
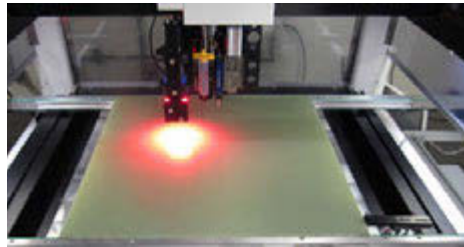

prepared by GPD Global® Documentation Department



611 Hollingsworth Street
Grand Junction, CO, USA 81505
tel: +1.970.245-0408 • fax +1.970.245-9674
request@gpd-global.com • www.gpd-global.com

Copyright © 2020 GPD Global® • All Rights Reserved

Contents

Release notes	iv
Legal	v
Safety notices	vi
Warranty	viii
Introduction	1
About this manual	1
System overview	1
Special features	1
General theory of operation	2
Specifications	3
System requirements	3
Related documents	4
Set up	5
Power up system	5
Power down system	5
Touchscreen	5
Select recipe	5
User interface	6
Operator station	6
Indicators	7
Screens	9
Keypad operations	9
Basic operations	11
Power on	11
Power off	11
Start up	11
Set online/offline state	14
Run system	14
Check temperature readiness	14
Use recipes	15
Clear an error	17
Routine maintenance	18
Periodic operations	18
Suggested spare parts	18
Troubleshooting	19
Problems and remedies	19
Error codes	20
System management	21
Update software	21
References	24
Recipes	25
Process parameters	27
Screens and dialogs	28

- Alarm states35
- Infrared camera sensor36
- Under board sensor38
- Assembly drawings39
- Known issues43**
- Glossary45**

Release notes

What's new in version 01.00.00

Recently completed

Radiant (as in shiny) new product - all new content.

Legal

Trademarks

- GPD Global[®] is a registered trademark of GPD Global[®], Inc.
- FLOWare[®] Software is a registered trademark of GPD Global[®], Inc.
- FLIR[®] is a registered trademark of FLIR Systems, Inc.
- Optris[®] is a registered trademark of Optris Infrared Sensing, LLC

Throughout this manual, trademarks are used. Rather than put a trademark symbol in every occurrence of a trademarked name, we state that we are using the names in an editorial fashion only and to the benefit of the trademark owner with no intention of infringement of the trademark.

Disclaimers

GPD Global[®] devices are intended for the stated functions at the time of sale. GPD Global[®] is not liable for other uses.

IMPORTANT: Operation of a damaged device may cause personal injury and invalidate the warranty.			
IMPORTANT: L'utilisation d'une machine endommagée peut entraîner des blessures personnelles et invalider la garantie.	WICHTIG Die Bedienung einer beschädigten Maschine kann zu Verletzungen des Bedieners sowie zur Ungültigkeit der Garantie führen.	IMPORTANTE Il funzionamento di un'apparecchiatura danneggiata può causare lesioni personali e invalidare la garanzia.	IMPORTANTE La utilización de una máquina averiada puede provocar lesiones e invalidar la garantía.

Safety notices



HIGH VOLTAGE: Shock hazard - Equipment is electrical in nature and shock may occur if used improperly or opened while powered.

Shock, injury, and death may occur. Unplug system before any maintenance or plugging or unplugging components.



WARNING: Appropriate use

This equipment must be used in the manner indicated in these instructions. Use for any other purpose may cause damage to the equipment, injury, or death.



CAUTION: Hot surface - Do NOT touch. Can cause skin burns upon contact. Disconnect and lockout power and allow surface to cool before servicing.



CAUTION: Warranty

Any of the following that are done without the explicit and written approval of the manufacturer:

- conversions or additions,
 - the use of non-original spare parts,
 - repairs carried out by companies or persons that have not been authorized by the manufacturer
- can lead to the warranty being rendered null and void. The manufacturer shall have no liability whatsoever for damage resulting from failure to follow the operation and maintenance instructions.



CAUTION: Qualifications of operating and maintenance personnel

The owner bears the responsibility for ensuring that operating and maintenance personnel have the required qualifications. The operation and maintenance instructions must be read and understood. Comply with the relevant applicable technical and safety regulations.



CAUTION: Organizational measures

The owner is to provide any personal protective equipment that is required. All the safety devices are to be checked regularly. Wear protective glasses and a protective suit for operation and cleaning to protect against any chemicals that may be sprayed out.



CAUTION: Exhaust considerations

End users should determine whether or not exhaust is required. Failure to provide exhaust may result in exposure to chemicals, resulting in illness injury and potentially death. When using hazardous materials, always provide enclosure with exhaust embedded and certified for use.



CAUTION: Flammable and volatile compounds

End users may select adhesives and compounds which are flammable and contain volatile organic compounds. End users must provide appropriate exhaust prevention of fire and other hazards in the final integration. Failure to provide such protection may result in fire resulting in damage to equipment the building in nearby environment, burns injuries and possibly death. End users must provide protection for fire risk generated by the chemicals of the use.

FLIR AX series camera



WARNING: Before using a liquid, read all MSDS and warning labels

Make sure you read all applicable MSDS (Material Safety Data Sheets) and warning labels on containers before you use a liquid. The liquids can be dangerous. Injury to persons can occur.



CAUTION: High temperatures can cause damage to the camera

Do not use the camera in temperatures more than +50° C (+122° F), unless other information is specified in the user documentation or technical data.

IMPORTANT: For a complete list of safety notices, refer to OEM instructions referenced here: [Related documents](#) (pg 4).

Optris infrared thermometer

IMPORTANT: Avoid abrupt changes of the ambient temperature.

IMPORTANT: Avoid mechanical violence on the head as this may destroy the sensitive optical system.

IMPORTANT: For a complete list of safety notices, refer to OEM instructions referenced here: [Related documents](#) (pg 4).

Touch screen monitor



WARNING: Do not expose touch screen monitor to moisture.

To prevent the risk of fire or shock hazard, do not expose this product to moisture.



CAUTION: Do not touch LCD display screen with sharp or hard objects.



CAUTION: Do not operate touch screen monitor under the following conditions:

extreme heat, cold or humidity, areas susceptible to excessive dust and dirt; near any appliance generating a strong magnetic field; in direct sunlight.



CAUTION: Do not use abrasive cleaners, waxes, or solvents for cleaning.

Warranty

General Warranty. Subject to the remedy limitation and procedures set forth in the Section “Warranty Procedures and Remedy Limitations,” GPD Global warrants that the system will conform to the written description and specifications furnished to Buyer in GPD Global’s proposal and specified in the Buyer’s purchase order, and that it will be free from defects in materials and workmanship for a period of one (1) year. GPD Global will repair, or, at its option, replace any part which proves defective in the sole judgment of GPD Global within one (1) year of date of shipment/invoice. Separate manufacturers’ warranties may apply to components or subassemblies purchased from others and incorporated into the system. THIS WARRANTY IS EXPRESSLY IN LIEU OF ANY AND ALL OTHER WARRANTIES, EXPRESS OR IMPLIED, INCLUDING WARRANTIES OF MERCHANTABILITY OR FITNESS FOR A PARTICULAR PURPOSE.

Limitations. GPD Global reserves the right to refuse warranty replacement, where, in the sole opinion of GPD Global the defect is due to the use of incompatible materials or other damages from the result of improper use or neglect.

This warranty does not apply if the GPD Global product has been damaged by accident, abuse, or has been modified without the written permission of GPD Global.

Items considered replaceable or rendered unusable under normal wear and tear are not covered under the terms of this warranty. Such items include fuses, lights, filters, belts, etc.

Warranty Procedures and Remedy Limitations. The sole and exclusive remedy of the buyer in the event that the system or any components of the system do not conform to the express warranties stated in the Section “Warranties” shall be the replacement of the component or part. If on-site labor of GPD Global personnel is required to replace the non-warranted defective component, GPD Global reserves the right to invoice the Buyer for component cost, personnel compensation, travel expenses and all subsistence costs. GPD Global’s liability for a software error will be limited to the cost of correcting the software error and the replacement of any system components damaged as a result of the software error. In no event and under no circumstances shall GPD Global be liable for any incidental or consequential damages; its liability is limited to the cost of the defective part or parts, regardless of the legal theory of any such claim. As to any part claimed to be defective within one (1) year of date of shipment/invoice, Buyer will order a replacement part which will be invoiced in ordinary fashion. If the replaced part is returned to GPD Global by Buyer and found by GPD Global in its sole judgment to be defective, GPD Global will issue to Buyer a credit in the amount of the price of the replacement part. GPD Global’s acceptance of any parts so shipped to it shall not be deemed an admission that such parts are defective.

Specifications, descriptions, and all information contained in this manual are subject to change and/or correction without notice.

Although reasonable care has been exercised in the preparation of this manual to make it complete and accurate, this manual does not purport to cover all conceivable problems or applications pertaining to this machine.

Introduction

About this manual

This document provides an overview and instructions for the Embedded Infrared Heater.

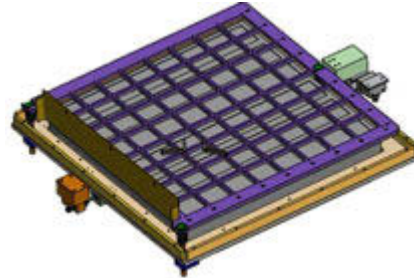
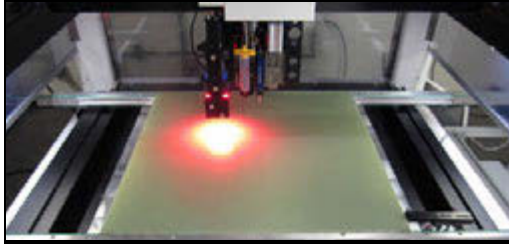

System overview

The Embedded Infrared Heater is designed for underside-infrared-heating operations.

A combination of temperature monitoring sensors accurately measure the temperature of the board in the work area to confirm the substrate is at operating temperature prior to running a process.

The Embedded Infrared Heater immediately attempts to achieve set point when online. Alternatively, the system immediately shuts down the heaters and idles the controller when in idle/stop mode.

If errors occur, the user can use reset to clear any errors.

Control of the Embedded Infrared Heater is activated by a running process.

Special features

The Embedded Infrared Heater features:

- Ceramic infrared heaters maintain substrate temperature.
- Over board remote IR camera sensor measures the temperature of the top side of the board.
- Under board remote IR sensor measures the temperature of the underside of the board.
- The system stores recipes which persist through a power cycle.

Camera/Sensor monitoring

The infrared temperature monitoring camera and sensor both measure the temperature of product in the nest area.

The sensor confirms the substrate is at operating temperature and enables the system to determine if the process is “ready to go”.

Online and offline states

The operator controls the online and offline states using the Online/Offline toggle button located on the Main screen.

Offline

Offline status is the non-operational/power up state. Equipment is idle and will not respond to heat requests from the system; i.e., “heater ready” is always false.

This is the safe/preferred state for any equipment change while the machine remains powered on.

Online

The system must be Online for any activation method to function. Equipment will respond to heat requests from the system, i.e., “heater ready” is asserted when surface of the board achieves the set point.

Online status is either actively running a process or waiting and immediately prepared to do so.

General theory of operation

A typical operational sequence for the Embedded Infrared Heater:

1. The operator prepares the system for operations:
 - a. Operator powers on the dispense system with the main power switch.
 - b. The Embedded Infrared Heater system initializes and attains offline state.
 - c. Operator selects and activates an appropriate recipe. Lacking this operator action, the last selected recipe becomes the currently selected recipe.
 - d. Operator sets the Embedded Infrared Heater to online.
2. The process proceeds automatically:
 - a. At the start of a process, the dispense system requests heat.
 - b. The process pauses until the “heater ready” signal is asserted.
 - c. If a board is detected in the nest (nest sensor), the heaters are enabled and controlled until the underside of the board achieves the “underside lo” set point.
 - d. When the top side of the board achieves the set point range, the “heater ready” signal is asserted and the process continues.
3. The board moves via conveyor to the exit station (downstream machine) and the Embedded Infrared Heater remains in online state.
4. The process of loading a board from upstream, heating it in the nest station, running a dispense process, and then unloading it to the downstream machine continues until product is unavailable from the upstream equipment or the operator cancels the program.
5. If an error occurs at almost any point during the process, an error displays to notify the operator. When the operator resets/clears the error, the system initializes and returns to offline state.
6. When processing is complete, the operator clears the dispense system of all product and powers off the machine.

Specifications

Capacity

- Product clearance Above board: ±25, 4 mm (±1.0"). Below board: ±25, 4 mm (±1.0")
- Product thickness Minimum/Maximum can vary; based on width of product and its rigidity
- Product dimensions . . . Up to maximum of 609.6 x 609.6 mm (24" x 24")
- Conveyor load capacity. Up to maximum of 13.6 kg (30 lbs)

Dimensions of Board Carrier

- Width 101.6 mm to 609.6 mm (4.0" to 24")
- Length 101.6 mm to 609.6 mm (4.0" to 24")

Power

- Supply voltage Input: 50 Amps @ 240 V
- Frequency 50/60 HZ
- Consumption rating 10 kw
- Power cable Customer supplies connection hardware to bare end of cable per customer's facility requirements/specifications for needed voltage.

Temperature

- Operating range +10° C to +50° C (50° F to 122° F)
- Facility range +10° C to +40° C (50° F to 104° F)

Heaters

- Heater elements Ceramic, 18 elements, 240 VDC

Conveyor

- In compliance with IPC SMEMA 9851 Mechanical Equipment Interface
Standard specification per SMEMA Interface Standard 1.2

Lifter plate

- Height preset at factory

Communications

- User interface Touch Screen with Infrared Preheat Module User Guide control software
- µSD card Software storage media
- Communication cables . . Cat6

System requirements

Summary of software and equipment needed to operate and control the Embedded Infrared Heater:

- Control Software (PN 2050-0104) - factory installed
- Infrared camera (over board temperature)
- Infrared thermometer (under board temperature)
- Ceramic heat unit
- Computer/HMI (user interface)

Related documents

For additional information about devices integrated with system function, refer to the following documents.

NOTE: All of these documents are included in your *Dispenser Manuals* documentation package.

- *FLOware*® Software Guide - PN 22100080D
- *Dispense System User Guide* - PN 22100079K
- *Dispense System Service Guide* - PN 22290008G
- *Infrared Camera User Manual for FLIR-AX8* - PN 22140088
- *Infrared Thermometer User Manual for Optris* - PN 22140089

Set up

Power up system

Perform the [Power on](#) (pg 11) procedure.

Power down system

To power down after finishing work in progress:

Perform the [Power off](#) (pg 11) procedure.

To immediately power down:

Press the Emergency Stop button on the control panel.

Touchscreen

As needed, change the viewing angle of the touch screen to accommodate the user.

Select recipe

Choose a recipe per [Select recipe](#) (pg 15) instructions to verify machine is operational after set up is complete.

User interface

Operator station

The touch screen, mounted to the left side of the dispenser system, serves as the operator station devoted to the Embedded Infrared Heater. The Embedded Infrared Heater is integrated into the dispense system and therefore uses that system's safety systems.

Figure 1: .Front of DS Series Dispenser System

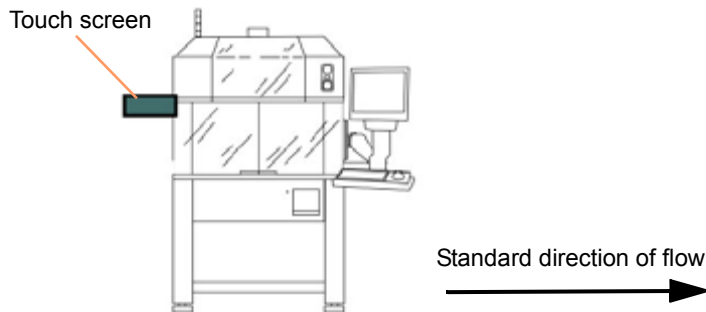

Safety systems

Under board and over board sensors track changing temperatures at appropriate times. If a heater is determined to not be changing temperature when it should be, the heater is disabled and an error is reported.

The equipment is tied to the dispense system safety circuitry. When a safety violation occurs, the equipment immediately disables heater elements and enters the Offline state.

Camera sensor

The camera sensor is preset at the factory. Access to this system is limited to qualified and trained personnel and/or GPD Global technicians only. Reference: [Infrared camera sensor](#) (pg 36).

Indicators

Main screen indicators

The following indicators display on the Main screen.

Offline

The Embedded Infrared Heater is offline when the On Line button is enabled. Offline status is confirmed by the **unchecked** Online status box.

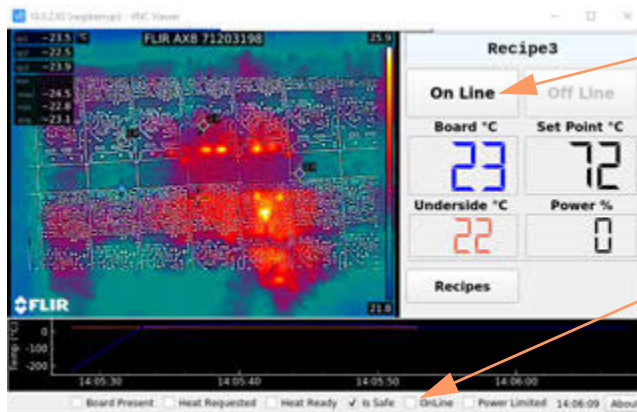

Online

The Embedded Infrared Heater is online when the On Line button is disabled and the Off Line button is enabled. Online status is confirmed by the **checked** Online status box.

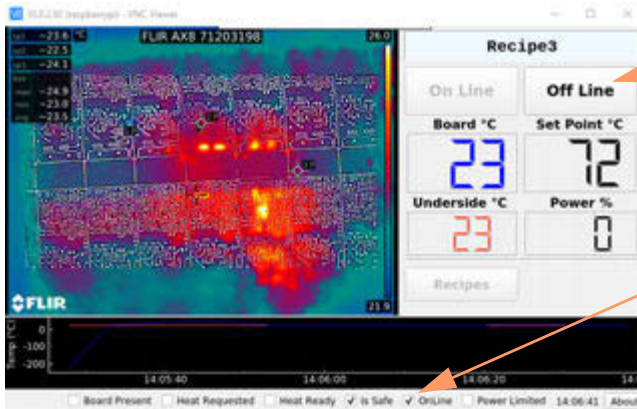

Safety violation

A safety violation is active when both the On Line and Off Line buttons are disabled.

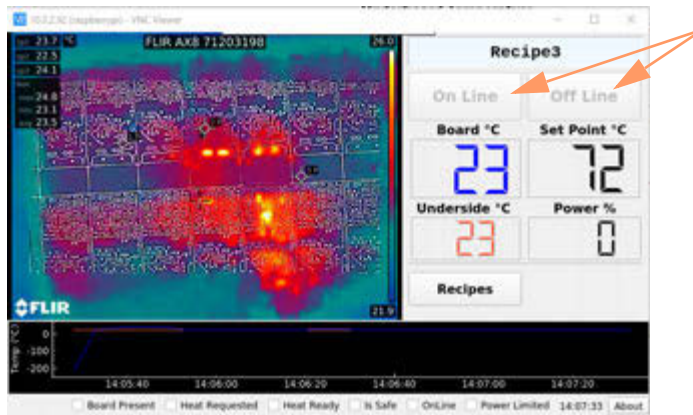

Error message

If an error occurs, an error dialog displays with an error code. Refer to [Error codes](#) (pg 20).

Figure 2: Example of error message with error code.



Screens

Refer to [Screens and dialogs](#) (pg 28) for an example of each user interface screen plus details about any button and field present.

Keypad operations

NOTE: If you use a glove or stylus to operate the touch screen, a capacitive type glove/stylus is required.

Display keyboard or numeric keypad

Touch the *left arrow* icon next to:

- *value* field to display popup *numeric keypad*

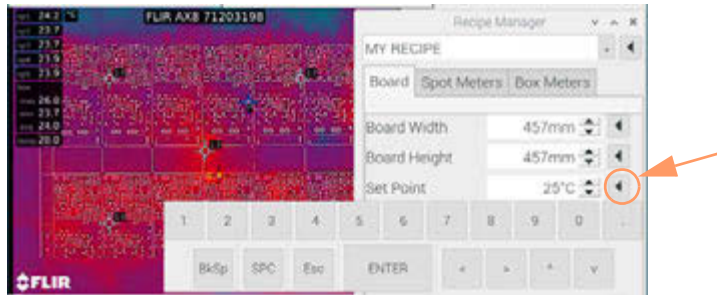

- *alphanumeric* field to display popup *keyboard*



Key functions

Key	Description	Function
BkSp	Backspace	Erases character before (to left of) the cursor's current position.
SPC	Space	Enters a space.
Esc	Escape	Cancel an entry and closes the keypad.
ENTER	Enter	Saves an entry and closes the keypad.
<	left arrow	Moves cursor left.
>	right arrow	Moves cursor right.
^	up arrow	Moves cursor up through drop down menu.
v	down arrow	Moves cursor down through drop down menu.

Drop down menu

Touch the drop down menu icon to display menu contents. In sample below, available recipes are displayed.

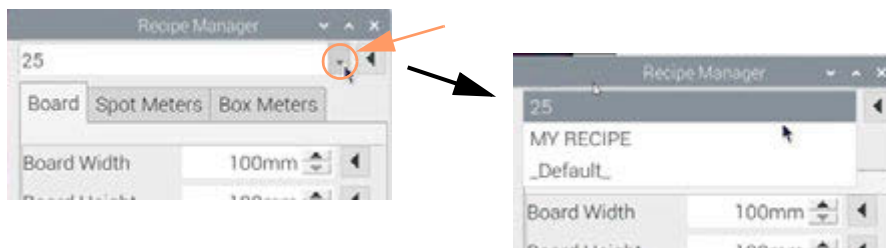

Increment/Decrement value

Use increment/decrement buttons to increase/decrease a displayed value by 1.



Text entry

Use the popup keyboard to type alphanumeric entries.

Numeric entry

Use the popup numeric keypad to type a numeric value or use the increment/decrement buttons to change displayed value. When entering a value, you may need to erase (BkSp key) the prior value before entering the new value.

Decimal places

Parameter values display decimal places when appropriate. If you try to enter decimal places where they are not used/displayed, the decimal portion of your entry will be ignored.

Basic operations

Power on

1. Power on the dispense system per the power on instructions in *Dispense System User Guide* (PN 22100079K).
2. Perform [Start up](#) (pg 11) procedure.

Power off

 **CAUTION:** Prior to cycling the machine through the power off/on procedure, assert a safety violation. The safety violation physically removes power from the heaters.

Start up

During start up, a sequence of operations occurs: initialization, device detection, starting services, and starting controllers. Progress through each operation is displayed via a series of splash screens.

Figure 3: The beginning of a normal, successful start up



Wait for successful splash screen.

Wait for the splash screen to indicate a normal, successful start up has been completed.

Successful start up: If all operations are successful, the startup sequence launches into the application proper.

Figure 4: A successful start up launches the application Main screen.

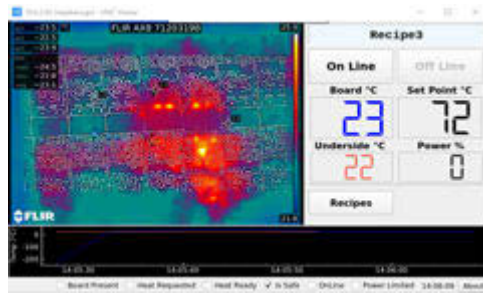

Failed start up: If a failure occurs during start up, the system halts and the last screen displayed provides information as to the cause.

If a start up failure occurs, refer to [Troubleshooting](#) (pg 19).

Figure 5: Example of failed start up.



Connection to camera

During system startup, “Media not connected” may display for several seconds. When the connection is complete, the live video image displays.

If a connection error occurs, refer to [Troubleshooting](#) (pg 19).

Figure 6: Upon successful connection, live video replaces the ‘Media not connected’ message.

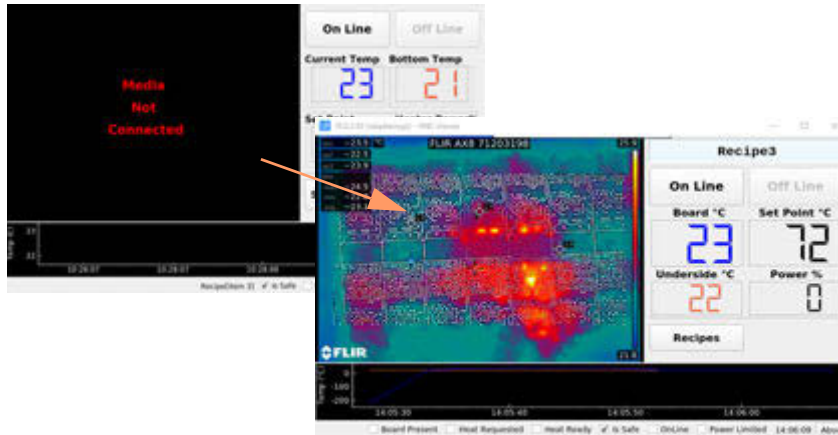

Camera warm up

Wait approximately 10 minutes for completion of the camera warm up process as indicated by the absence of all temperature *prefixes*. For examples and definitions of prefixes, refer to [Camera warm up period](#) (pg 37).

The camera image displayed immediately after startup will fluctuate until temperature measurements become stable. Refer to [Cold start instability](#) (pg 36).

Set online/offline state

The system starts up in the offline state. It must be set online in order to run a process.

1. On startup, the last selected recipe is the currently selected recipe.
2. Set the Embedded Infrared Heater to an online or offline state using the On Line and Off Line buttons.
3. Confirm state by noting the status indicators for [Offline](#) (pg 7) and [Online](#) (pg 7).

Run system

Board position

For optimum heating, regardless of board size, board position **must**: be positioned at front right-hand corner of the heated area - refer to Figure 7. This is both the origin point (0,0) of the heated area and the location of the nest present sensor.

Best practices assumes board is positioned with its longest dimension parallel to the conveyor rail. (Only the front conveyor rail is shown in Figure 7.)

Figure 7: Top view - Proper board placement (regardless of board size) above heated work area

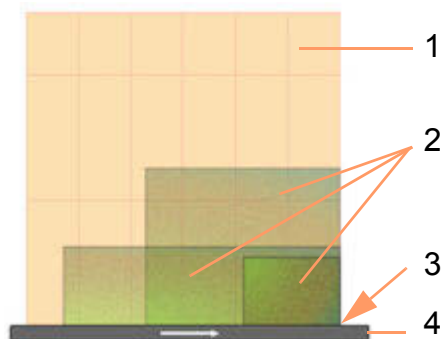

Item	Name
1	Heated work area
2	Correct board placement illustrated for various board sizes
3	Origin point (0,0)
4	Front conveyor rail Direction of travel arrow

Check temperature readiness

The temperature is ready when the Heat Ready check box [located in [Main](#) (pg 29) status bar] indicates a board is ready to be sent to the downstream machine.

Use recipes

NOTE: If you use a glove or stylus to enter values on the touch screen, a capacitive type glove/stylus is required.

Select recipe

The recipe name displayed in the first field of the [Recipe Manager](#) (pg 31) is the currently selected recipe.

To select a recipe:

1. From the [Main](#) (pg 29) screen, touch the RECIPES button to open the [Recipe Manager](#) (pg 31).
2. Touch the drop down menu icon. Available recipes display.

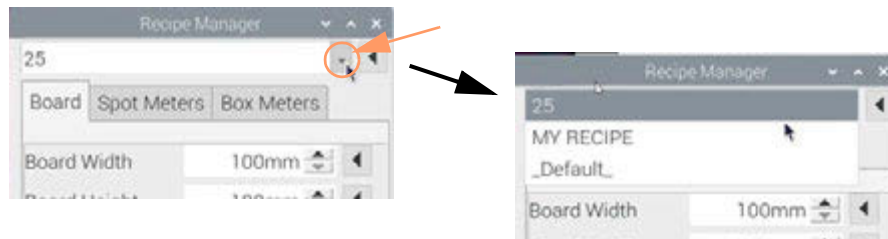

3. From the recipes listed, touch the name of desired recipe.

The name of the newly selected recipe displays and the drop down menu disappears.

4. Touch the OK button to make your selection the currently selected recipe.

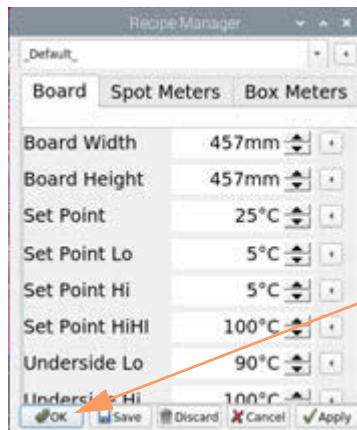

Change recipe heat parameters

To change the value of any displayed parameter, including the name, of an existing recipe:

1. Touch the RECIPES button on the [Main](#) (pg 29) screen.

The [Recipe Manager](#) (pg 31) opens.

2. From the Recipe Manager, select the recipe you want to edit per [Select recipe](#) (pg 15).
3. Using [Keypad operations](#) (pg 9), make desired edits to any/all of the [Board parameters](#) (pg 32), [Spot Meters parameters](#) (pg 33), and/or [Box Meters parameters](#) (pg 34).

4. *Optional:* To preview the effects of an edit without saving it to the recipe:
 - a. Touch the APPLY button.
 - b. Run a test.
 - c. If you're not happy with the results, either make additional changes and continue to the next step or touch the CANCEL button to exit the recipe dialog without saving the modifications.
5. When edits are complete, touch the SAVE button to save modifications.

Add recipe

To add a recipe:

1. From the [Main](#) (pg 29) screen, touch the RECIPES button to open the [Recipe Manager](#) (pg 31).
2. From the [Recipe Manager](#) (pg 31), select an existing recipe to use as the basis of the new recipe.

HINT: If one is available, select an existing recipe similar to the one you want to create.

3. Display the keyboard by touching the left arrow icon next to the recipe name field.



4. Key in a recipe name.

NOTE: Recipes names can consist of up to 30 alphanumeric characters.

5. Touch the keyboard ENTER button.
6. Touch the SAVE button.

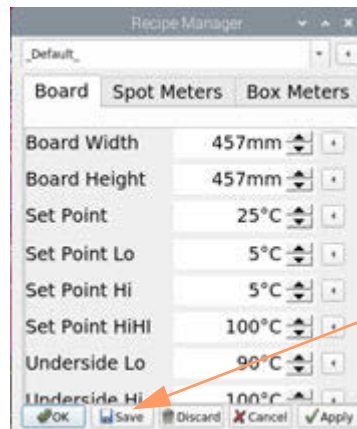

The newly named recipe is saved and the Recipe Manager closes.

7. To finish creating the new recipe:
 - a. Reopen the Recipe Manager by touching the RECIPES button.
 - b. Select your newly saved recipe from the drop down menu.
 - c. Edit and save parameter values, as needed, per [Change recipe heat parameters](#) (pg 15).

Delete recipe

Discarding a recipe deletes it from the database.

1. From the [Main](#) (pg 29) screen, touch the RECIPES button to open the [Recipe Manager](#) (pg 31).
2. From the [Recipe Manager](#) (pg 31), select the recipe you want to delete.
3. Touch the DISCARD button to delete the recipe.

Clear an error

If an error occurs, an error dialog displays that provides keywords and an error code to help you deduce the problem and find a solution.

NOTE: An error condition places unit offline.

To clear an error:

1. Note the information displayed by the error dialog.

Figure 8: Error dialog with error code (1501) and key phrases (over temp condition detected)



2. Clear all error issue conditions using [Troubleshooting](#) (pg 19) and [Error codes](#) (pg 20) to work out cause and solution.
3. Click the OK button in the error dialog.

The system should become operational.

Routine maintenance

Periodic operations

Under board remote IR sensor

Refer to safety and maintenance instructions in OEM instructions referenced here: [Related documents](#) (pg 4).

Over board remote IR sensor (camera)

Refer to safety and maintenance instructions in OEM instructions referenced here: [Related documents](#) (pg 4).

Touch screen monitor



CAUTION: Do not use abrasive cleaners, waxes, or solvents for cleaning.

Suggested spare parts

Table 1: Spare parts for Embedded Infrared Heater, PN 22151020-0001

Description	General Location	Part No.	Qty
SD Card, Preloaded	HMI controlled heater	22100165	1

Troubleshooting

This section is intended for use by maintenance/service personnel. As needed, contact the GPD Global Service Department at <https://helpdesk.gpd-global.com/support/home> or +1.970-245-0408.



IMPORTANT: Before performing any troubleshooting, read all [Safety notices](#) (pg vi).

Problems and remedies

For issues not listed here, refer to [Error codes](#) (pg 20) and/or [Known issues](#) (pg 43).

Start up sequence halts

If the system fails to detect hardware or a disconnect occurs, verify the network cable is plugged in.

Connection error message displays

If an error message similar to the following image displays, the network communications cable may have become disconnected from the HMI. Verify the network cable is plugged in.

Figure 9: Connection error message

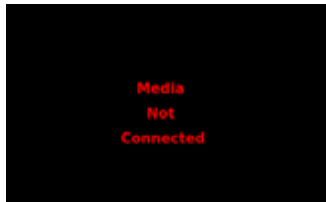

Heater not changing temperature when expected

If the heater is not changing temperature when you expect it to:

- Check the circuit breaker. If the circuit breaker is off, turn it on.
- Hi power may not be connected due to a blown thermal fuse. Refer to Dispense System Service Guide (PN 22290008G).
- The thermocouple may be broken. Contact the GPD Global Service Department for help.

Known issues pending resolution

The software for this product is under constant development, and some issues are known but not yet fixed. They are described here: [Known issues](#) (pg 43).

Error codes

Table 2: Error codes for Embedded Infrared Heater

Error Code	Symbol	Description	Notes
1100	AppError	unspecified error	This is a general, undefined and unexpected failure
1101	Safety Error	Safety Violation Active	
1500	AppError	unspecified error	This is a general, undefined and unexpected failure
1501	OvertempConditionDetected	The OptrisCT underboard temperature sensor is reporting an over temp condition	This is a hardware limit set on the OptrisCT device itself.
1502	UnderboardTemperature-OutOfLimit	The OptrisCT underboard temperature sensor is reporting a temperature in excess of UnderboardLimitHiHi	
1503	UnderboardSensorHead-OutOfLimit	The OptrisCT underboard temperature sensor head is reporting a temperature in excess of UnderboardHeadLimitHiHi	
1504	OverboardSensorHeadOutOfLimit	The FLIR sensor is reporting a sensor head temperature above OverBoardHeadTemperatureLimitHi	Mfg Temp limit is 50°C
1505	OverboardTempertureOutOfLimit	The maximum reported over board temperature exceeds the SetPointLimitHiHi	
1506	HeaterElementsNotHeating	Power is applied to heaters for more than 30 seconds and the heaters' temperature has not changed by more than 10°C	Sensor is a thermocouple embedded in the heater element array at position A1
1507	UnderboardSensorFailure	Power is applied to heaters and the underboard sensor reported temperature is not changing.	Process Error > 10 and sensor value delta (30s) < 1
1508	OverBoardSensorNonResponsive	FLIR sensor is reporting no temperature changes within a 53 second period - delta=0.0	It's expected that the sensor will report at least 0.2°C changes relatively frequently. This is an indication of the sensor being 'locked up'
1509	CPUTemperatureOutOfLimit	System's CPU temperature exceeds CPU Temperature Limits HiHi	Mfg. recommends maximum of 5°C

System management

Update software

Is update available?

When an update for the control software is available, an UPDATE button will display on the [About](#) (pg 28) screen.

To determine whether or not an update is available:

1. From the Main screen, touch the ABOUT button located in the status bar to open the [About](#) (pg 28) screen.
2. Look for an UPDATE button on the About screen:
 - If no update is currently available, the UPDATE button will not be present.
 - If an update is available, an UPDATE button will be present. Skip to [How to update software](#) (pg 21).

Figure 10: An UPDATE button is present when an update to the control software is available.



How to update software

To update the control software:

1. Obtain the most current software release from GPD Global via download.
2. Copy the update file to a USB device.

Example of update file name: 22151020-0001_01.00.00.tar.gz

IMPORTANT: The file must be placed in a folder path of \GPDGlobal\Software.

Example:

I:\GPDGlobal\Software\22151020-0001_01.00.00.tar.gz

3. Plug the USB device into the HMI USB port located on side of the touch screen/HMI.
4. From the Main screen, touch the ABOUT button located in the status bar to open the [About](#) (pg 28) screen.

5. Touch the UPDATE button.

The UPDATE button is present only when an update is available.

Figure 11: An UPDATE button is present when an update to the control software is available.



6. Wait for the installer application to appear. It may take several seconds for the installer application to display.

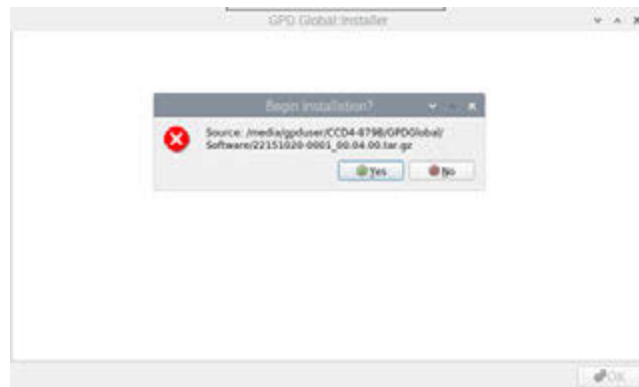

7. Touch the YES button to begin installation. Alternatively, touch the NO button to abort installation.

If you pressed YES, installation begins. Messages display in the installer window. When installation is complete, the OK button becomes enabled.



8. When the reboot dialog displays, touch YES.



CAUTION: Always reboot after a software update; otherwise, undefined behavior may result.

(Pressing the NO button causes the installer window to disappear and the application window to reappear.)



The software update is complete.

References

- [Recipes](#) (pg 25)
- [Process parameters](#) (pg 27)
- [Screens and dialogs](#) (pg 28)
- [Alarm states](#) (pg 35)
- [Infrared camera sensor](#) (pg 36)
- [Under board sensor](#) (pg 38)
- [Assembly drawings](#) (pg 39)

Recipes

Default recipe

On start up, the last selected recipe becomes the default selected recipe.

X, Y coordinates

Camera meter coordinates (x, y) are defined in the Spot Meters tab and the Box Meters tab of the [Recipe Manager](#) (pg 31).

- Coordinates for both Spot and Box meters are expressed in units of camera coordinates.
- Origin point coordinates (0, 0) of the camera view are located in the upper left corner.

Figure 12: Camera meter coordinate fields identified in Recipe Manager.

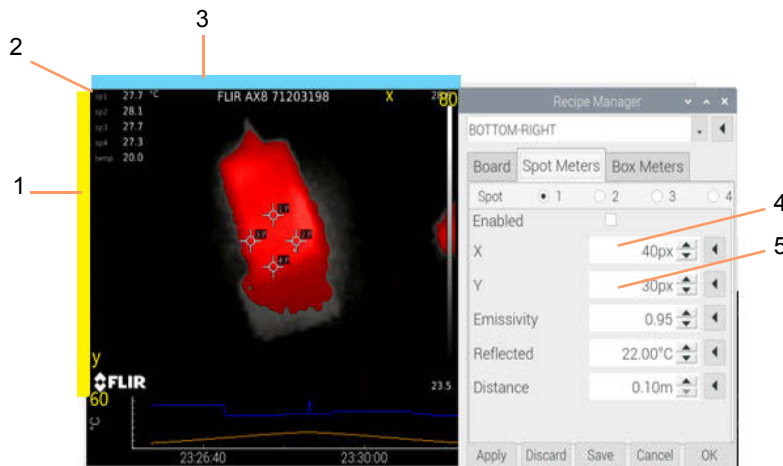

Item	Name	Description
1	Y axis	y=0 is the origin point y=60 is the bottom of the image
2	origin point	(0,0) is located in upper left corner of camera view.
3	X axis	x=0 is the origin point x=80 is the point on the camera image situated furthest to the right
4	X coordinate field	0 to 79 range.
5	Y coordinate field	0 to 59 range.

Temperature control vs temperature ready

Embedded heating systems must account for possible moments of occlusion by the dispense system gantry.

Temperature control. Temperature control is performed by comparing the process SetPoint value against the process Value. The difference between the two is the process Error.

- the SetPoint Value is the recipe Underboard LimitLo parameter.
- the source of the process Value is the UnderBoard Sensor instantaneous value.

Temperature ready. The temperature ready condition is based on the process SetPoint, the SetPointLimits (low/high), and the current process Value.

- the source of the process Value is the infrared camera sensor. The *simple mean* value of all active Spots and Boxes (box average) is calculated with the result being the process Value.
- If the process Value falls within the range defined by the SetPoint and the Lo/Hi limits, the process is considered Ready.

Process parameters

This overview of the fundamental process parameters illustrates how these parameters inter-relate with the programming to produce desired results for operations.

Table 3: Parameter definitions

Name	Type	Description	Notes
Set Point	°C	Target temperature for board top surface	
Set Point Low	offset	Lowest acceptable temperature for 'process ready'	This is an offset value from the current Set Point. This value is <i>added</i> to the set point to calculate the high limit.
Set Point High	offset	Highest acceptable temperature for 'process ready'	This is an offset value from the current Set Point. This value is <i>subtracted</i> from the Set Point to calculate the low limit.
Set Point Low Low	offset	Lowest possible value at which the machine will operate.	NOT USED
Set Point High High	offset	Highest temperature allowed for the top surface of the board. If this temperature is exceeded the machine is immediately shutdown and placed in an error condition. This is done to prevent damage to the board and/or itself.	Note that the value compared to this limit is <code>Process Value Max</code> i.e. the highest reported temperature - not the mean temperature.
UnderBoard Limit Low	°C	Value at which the system begins to limit the power output to the heaters. When the process value is at or above this value and below the UnderBoard Limit High, output power is reduced by inverse of the difference between the process value and the UnderBoard Limit High. If the process value is below this value, the power output is not limited (i.e. 100% allowed.)	scaling function: $power = \frac{(limit_{hi} - pv)}{((limit_{hi} - limit_{lo}) / 100.0)}$
UnderBoard Limit High	°C	Value at which systems disallows power to the heaters. If the process value exceeds this value, no power is allowed to the heaters (i.e. the power is limited to 0%).	
UnderBoard Limit High High	°C	Value at/above which the system will immediately shut down and placed in an error condition. This is done to prevent damage to the board and/or itself.	
Product Height	mm	Board/product height in millimeters	Height refers to the distance between the conveyor rails.
Product Width	mm	Board/product width in millimeters	Width refers to the distance along the conveyor direction of travel.

Camera sensor setup

- Box meter contributes *mean temperature* to Aggregate Process Value
- Box meter contributes *maximum temperature* to Process Variable Maximum
- IR Sensor Resolution 80 × 60 pixels

Screens and dialogs

This section provides an overview of the functions provided by each screen/dialog, and details for any field and button present.

- [About](#) (pg 28)
- [Main](#) (pg 29)
- [Recipe Manager](#) (pg 31)

About

The About screen details the version and release date of the control software, plus the name, part number, and serial number of the device controlled by the control software.

The About screen is opened by clicking ABOUT in the status bar of the Main screen.

Figure 13: About screen



The About screen also indicates when a control software update is available; notice the appearance of the UPDATE button. For further details, refer to [Update software](#) (pg 21).

Figure 14: An UPDATE button is present when an update to the control software is available.





Main

The Main screen displays when system start up is completed. Use the Main screen to:

- enable/disable the Infrared Preheat Module
- access the Recipe Manager
- view the camera display
- view a plot of temperatures monitored over time
- monitor the top and bottom side temperatures of the board
- monitor the current process set point and amount of heater power
- monitor recipe selection, current system state, and other status information

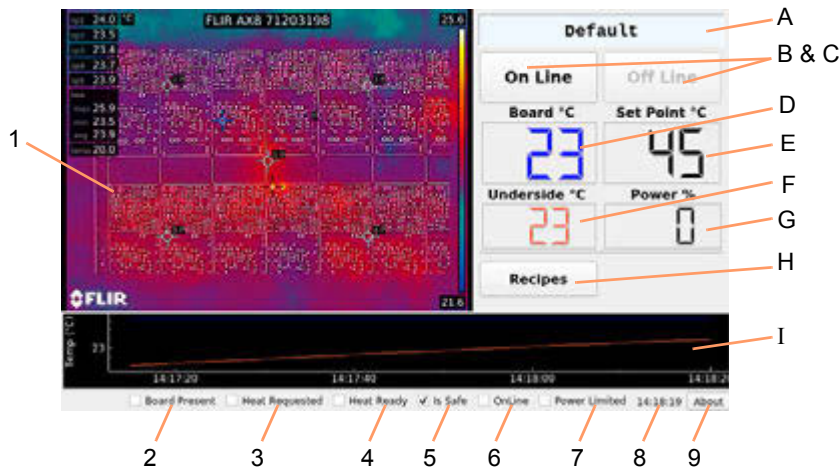
Figure 15: Main screen



Item	Name	Description
A	[varies]	Current recipe
B	On Line	Touch the On Line button to place unit online. Buttons appear like this  to indicate unit is online. Status is also indicated by the Online box (Item 6) in status bar.
C	Off Line	Touch the Off Line button to place unit offline. Buttons appear like this  to indicate unit is offline. Status is also indicated by the Online box (item 6) in status bar.
D	Board ° C	Current top side temperature
E	Set Point ° C	Process set point
F	Underside ° C	Current bottom side temperature
G	Power %	Current heater power (% of full scale)
H	Recipes	Opens Recipe Manager (pg 31).
I	Time/Temperature graph	Plot of top/bottom temperatures over time.
1	Camera image	IR camera sensor image
2	Board Present	If checked, board is present in system nest. (nest present sensor)
3	Heat Requested	If checked, heat is being requested from system.
4	Heat Ready	If checked, temperature of the board is within set point limits.

5	Is Safe	If checked, the safety circuit is closed (safe).
6	Online	If checked, the device is online; otherwise the device is offline.
7	Power Limited	If checked, power is limited to excessive underboard temperature (underboard limit hi).
8	Clock	Current time.
9	About Button	Opens About (pg 28) dialog.

Recipe Manager

Use the Recipe Manager to create, edit, delete, or activate a recipe. It also enables you to test recipe modifications as if they were the active recipe without saving the changes to the recipe.

The Recipe Manager dialog is opened by clicking the SELECT RECIPE button on the Main screen.

- [Common tab elements](#) (pg 31)
- [Board parameters](#) (pg 32)
- [Spot Meters parameters](#) (pg 33)
- [Box Meters parameters](#) (pg 34)

Common tab elements

The elements noted and described in this section are common to all tabs in the Recipe Manager.



Item	Description										
recipe name	Name of the currently selected recipe.										
Tabs	Tab selections available: <ul style="list-style-type: none"> • Board - opens a tab of Board parameters (pg 32) • Spot Meters - opens tab of Spot Meters parameters (pg 33) • Box Meters - opens tab of Box Meters parameters (pg 34) 										
button bar	<table border="0"> <tr> <td>OK</td> <td>Makes the currently selected recipe the active recipe. If you have modified the recipe, you will be prompted to save/lose those modifications.</td> </tr> <tr> <td>SAVE</td> <td>Saves modifications to the selected recipe without making it the active recipe.</td> </tr> <tr> <td>DISCARD</td> <td>Deletes the selected recipe from the database.</td> </tr> <tr> <td>CANCEL</td> <td>Exits the dialog without saving modifications.</td> </tr> <tr> <td>APPLY</td> <td>Makes the currently selected recipe <i>and any modifications</i> the active recipe. TIP: Use APPLY to test the effect of modifications without saving those changes to the recipe database.</td> </tr> </table>	OK	Makes the currently selected recipe the active recipe. If you have modified the recipe, you will be prompted to save/lose those modifications.	SAVE	Saves modifications to the selected recipe without making it the active recipe.	DISCARD	Deletes the selected recipe from the database.	CANCEL	Exits the dialog without saving modifications.	APPLY	Makes the currently selected recipe <i>and any modifications</i> the active recipe. TIP: Use APPLY to test the effect of modifications without saving those changes to the recipe database.
OK	Makes the currently selected recipe the active recipe. If you have modified the recipe, you will be prompted to save/lose those modifications.										
SAVE	Saves modifications to the selected recipe without making it the active recipe.										
DISCARD	Deletes the selected recipe from the database.										
CANCEL	Exits the dialog without saving modifications.										
APPLY	Makes the currently selected recipe <i>and any modifications</i> the active recipe. TIP: Use APPLY to test the effect of modifications without saving those changes to the recipe database.										

Board parameters

Board parameters define the board to be processed.

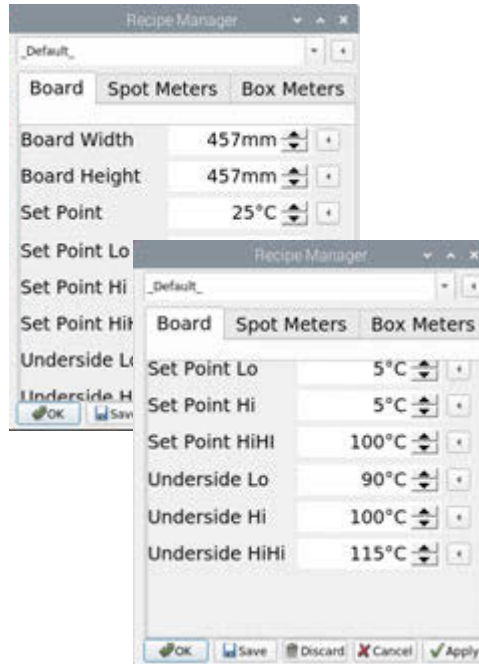

Item	Description	
Board tab	Board Width	Distance (mm) between the conveyor rails.
	Board Height	Distance (mm) along the conveyor direction of travel - the axis of motion.
	Set Point	Desired value of the Process Variable (pg 46).
	Set Point Lo	Used together, Set Point Lo and Set Point Hi establish a numerical process limit range. When the process value falls within this range, the process is <i>ready</i> . If the process value is outside this range, the process is <i>not ready</i> .
	Set Point Hi	
	Set Point HiHi	The upper limit for a process variable at which damage is possible to the machine or the product. Typically, when a process value exceeds a high high limit, the equipment reports an error and shuts itself down to prevent damage.
	Underside Limit Lo	The low value of the process acceptance range for the underside of the board.
	Underside Limit Hi	The high value of the process acceptance range for the underside of the board.
	Underside Limit HiHi	The upper limit for a process acceptance range at which damage is possible to the machine or the product. Typically, when a process value exceeds a high high limit, the equipment reports an error and shuts itself down to prevent damage.

Spot Meters parameters

Spot meter parameters define metering for a specific coordinate on the top side of the board.

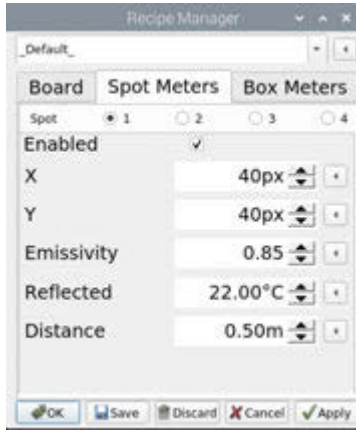

Item	Description
Spot Meters tab	Spot 1 Spot 2 Spot 3 Spot 4
Enabled	A meter must be enabled for it to be used.
X Y	Coordinates of the spot. Also refer to X, Y coordinates (pg 25).
Emissivity	Emissivity (pg 45) is a measure of radiation emitted from the board.
Reflected	Represents the Reflected apparent temperature (pg 46) which is used to compensate for the radiation reflected in the board.
Distance	Distance (pg 45) is the amount of space between the board and the front lens of the camera.

Box Meters parameters

Box meter parameters define metering for a specific rectangular area on the top side of the board.

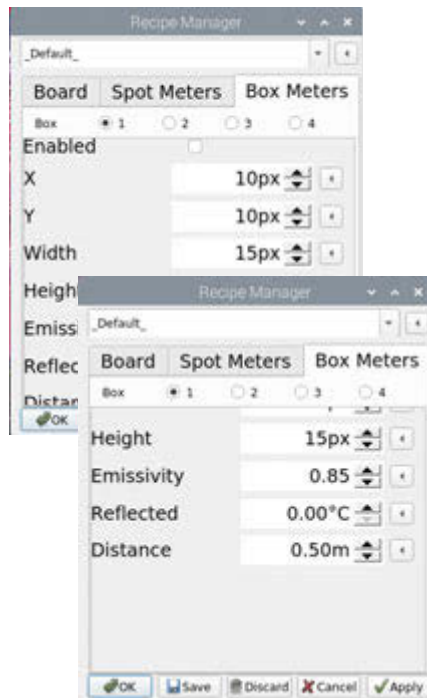

Item	Description
Box Meters tab	Box 1 Box 2 Box 3 Box 4
Enabled	A meter must be enabled for it to be used.
X	Location of the upper left corner of the box. Also refer to X, Y coordinates (pg 25).
Y	
Width	Width of the box.
Height	Height of the box.
Emissivity	Emissivity (pg 45) is a measure of radiation emitted from the board.
Reflected	Represents Reflected apparent temperature (pg 46) which is used to compensate for the radiation reflected in the board.
Distance	Distance (pg 45) is the amount of space between the board and the front lens of the camera.

Alarm states

Refer to status light tower color details in the system documentation: *Dispense System Service Guide* (PN 22290008G).

Infrared camera sensor

NOTE: Aside from the guidelines in this document, refer to OEM instructions referenced here: [Related documents](#) (pg 4).

The infrared camera is used as the over board remote IR sensor to measure the temperature of the top side of the board.

By supplying the following object parameters to the camera, the camera compensates for the effects of these different radiation sources and accurately measures – online and automatically – temperature.

- The reflected apparent temperature
- The distance between the object and the camera
- The relative humidity
- Temperature of the atmosphere

Cold start instability

Camera power turns on/off automatically with system power.

The following figure is representative of a fairly common camera image that displays immediately after startup. This image is indicative of the temperature measurements being unstable.

Figure 16: Example of camera image displaying temperature measurements being unstable.

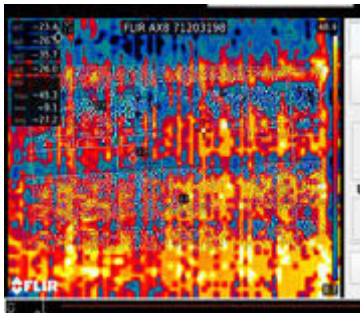

After allowing the camera to self calibrate and thermally stabilize, the image clears and the temperatures report as stable, similar to the following figure. To determine with certainty if temperatures are stable or unstable, refer to [Camera warm up period](#) (pg 37).

Figure 17: Example of camera image after temperature measurements have settled into stability.

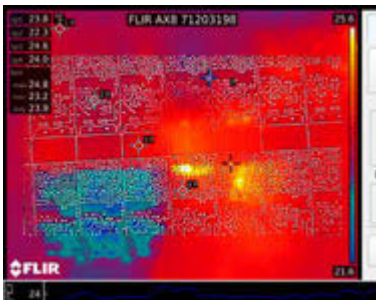

Camera warm up period

The camera requires a warm up period when first powered on. Immediately after a cold start, the camera reports temperatures as unstable by displaying a *prefix* (refer to Figure 18). When all prefixes disappear, the camera reports accurate temperatures.

NOTE: It is **inadvisable** to use the system **before the prefixes disappear** because reported temperatures are invalid until the prefixes are no longer displayed.

NOTE: The camera warm up period applies to powering the camera up, not necessarily to how warm it is; i.e., a stable temperature state must be achieved, not a particular temperature value.

Figure 18: *Until the camera has warmed up, temperatures reported in the camera view are unstable and display a prefix. (A) Prefixes = unstable temperatures. (B) No prefixes = stable temperatures.*

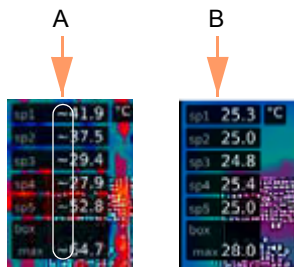

Table 4: *Key to prefixes*

Prefix	Stability of reported value	Description of actual value
	stable	Stable
>	inaccurate	Less than reported temperature
<	inaccurate	More than reported temperature
O	inaccurate	Outside range
*	inaccurate	Outside calibration range
~	inaccurate	Unstable

Under board sensor

NOTE: Aside from the guidelines in this document, refer to OEM instructions referenced here: [Related documents](#) (pg 4).

An infrared sensor (thermometer) is used as under board remote IR sensor to measure the temperature of the underside of the board.

Assembly drawings

- [IR Ceramic Process Heat with Lifter](#) (pg 40)
- [Sub assemblies](#) (pg 41): Camera, Sensor Mount, Touch Screen, Power
- [Electronics Panel](#) (pg 42)

IR Ceramic Process Heat with Lifter

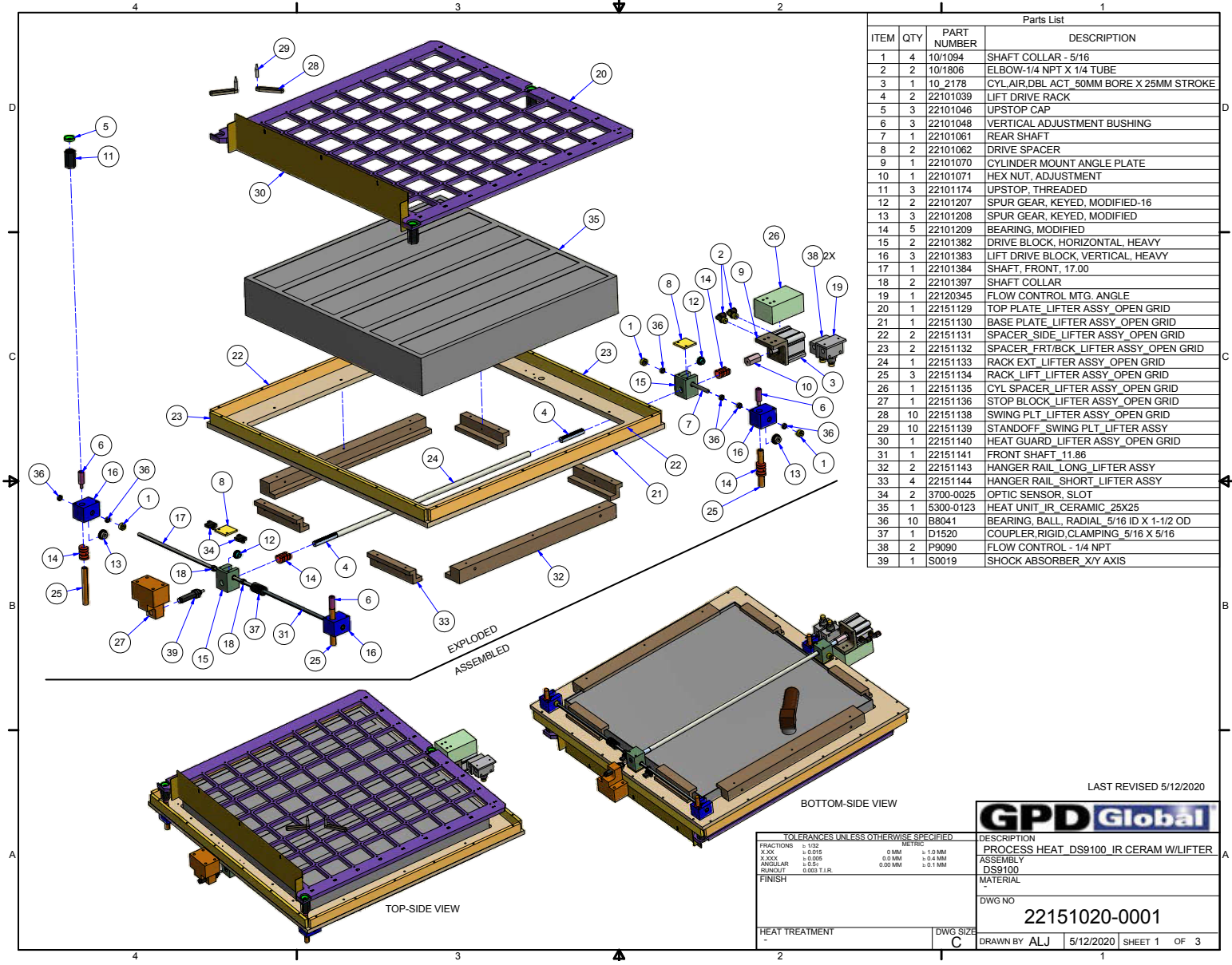

Parts List			
ITEM	QTY	PART NUMBER	DESCRIPTION
1	4	10/1094	SHAFT COLLAR - 5/16
2	2	10/1806	ELBOW-1/4 NPT X 1/4 TUBE
3	1	10_2178	CYL.AIR,DBL ACT_50MM BORE X 25MM STROKE
4	2	22101039	LIFT DRIVE RACK
5	3	22101046	UPSTOP CAP
6	3	22101048	VERTICAL ADJUSTMENT BUSHING
7	1	22101061	REAR SHAFT
8	2	22101062	DRIVE SPACER
9	1	22101070	CYLINDER MOUNT ANGLE PLATE
10	1	22101071	HEX NUT, ADJUSTMENT
11	3	22101174	UPSTOP, THREADED
12	2	22101207	SPUR GEAR, KEYED, MODIFIED-16
13	3	22101208	SPUR GEAR, KEYED, MODIFIED
14	5	22101209	BEARING, MODIFIED
15	2	22101382	DRIVE BLOCK, HORIZONTAL, HEAVY
16	3	22101383	LIFT DRIVE BLOCK, VERTICAL, HEAVY
17	1	22101384	SHAFT, FRONT, 17.00
18	2	22101397	SHAFT COLLAR
19	1	22120345	FLOW CONTROL MTG. ANGLE
20	1	22151129	TOP PLATE, LIFTER ASSY, OPEN GRID
21	1	22151130	BASE PLATE, LIFTER ASSY, OPEN GRID
22	2	22151131	SPACER, SIDE, LIFTER ASSY, OPEN GRID
23	2	22151132	SPACER, FRT/BCK, LIFTER ASSY, OPEN GRID
24	1	22151133	RACK EXT, LIFTER ASSY, OPEN GRID
25	3	22151134	RACK, LIFT, LIFTER ASSY, OPEN GRID
26	1	22151135	CYL SPACER, LIFTER ASSY, OPEN GRID
27	1	22151136	STOP BLOCK, LIFTER ASSY, OPEN GRID
28	10	22151138	SWING PLT, LIFTER ASSY, OPEN GRID
29	10	22151139	STANDOFF, SWING PLT, LIFTER ASSY
30	1	22151140	HEAT GUARD, LIFTER ASSY, OPEN GRID
31	1	22151141	FRONT SHAFT, 11.86
32	2	22151143	HANGER RAIL, LONG, LIFTER ASSY
33	4	22151144	HANGER RAIL, SHORT, LIFTER ASSY
34	2	3700-0025	OPTIC SENSOR, SLOT
35	1	5300-0123	HEAT UNIT, IR, CERAMIC, 25x25
36	10	B8041	BEARING, BALL, RADIAL, 5/16 ID X 1-1/2 OD
37	1	D1520	COUPLER,RIGID,CLAMPING, 5/16 X 5/16
38	2	P9090	FLOW CONTROL - 1/4 NPT
39	1	S0019	SHOCK ABSORBER, X/Y AXIS

LAST REVISED 5/12/2020

GPD Global

DESCRIPTION
PROCESS HEAT_DS9100_IR CERAM W/LIFTER

ASSEMBLY
DS9100

MATERIAL
-

DWG NO
22151020-0001

DRAWN BY ALJ 5/12/2020 SHEET 1 OF 3

TOLERANCES UNLESS OTHERWISE SPECIFIED	
METRIC	
FRACTIONS	± 1/32
XXX	± 0.015
XX	0.0MM ± 0.04MM
X	0.005 ± 0.025
ANGULAR	± 0.5°
RADIUS	0.00MM ± 0.1MM
FINISH	0.003 F.R.

Sub assemblies

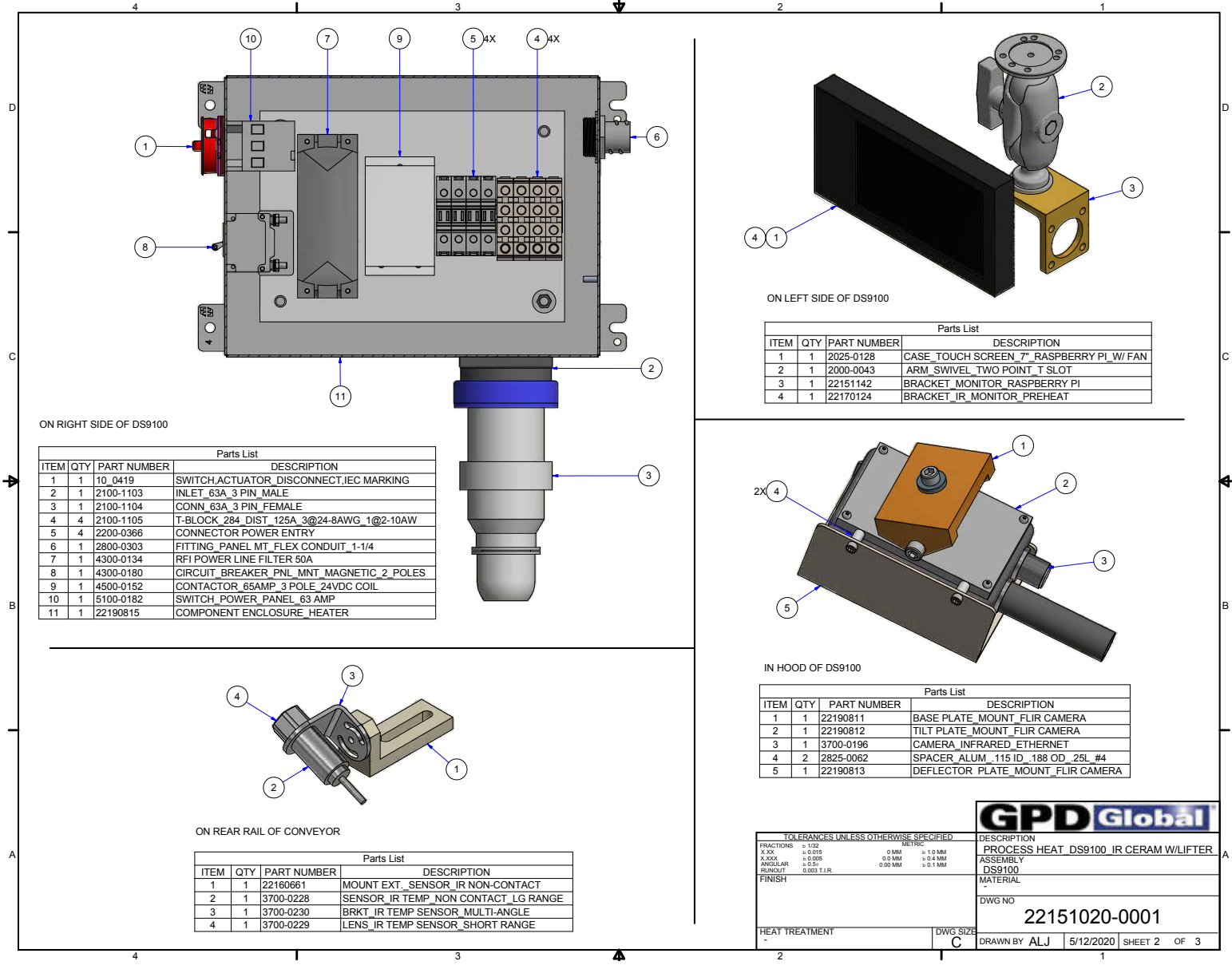

TOLERANCES UNLESS OTHERWISE SPECIFIED		DESCRIPTION
FRACTIONS ± 1/32		PROCESS HEAT_DS9100_IR CERAM W/LIFTER
DECIMALS ± 0.015		ASSEMBLY
X.XX ± 0.025		DS9100
X.XXX ± 0.005		MATERIAL
ANGULAR ± 0.5°		DWG NO
RADIUS ± 0.003 T.I.R.		22151020-0001
FINISH		HEAT TREATMENT
-		DWG SIZE
-		C

DRAWN BY ALJ 5/12/2020 SHEET 2 OF 3

Electronics Panel

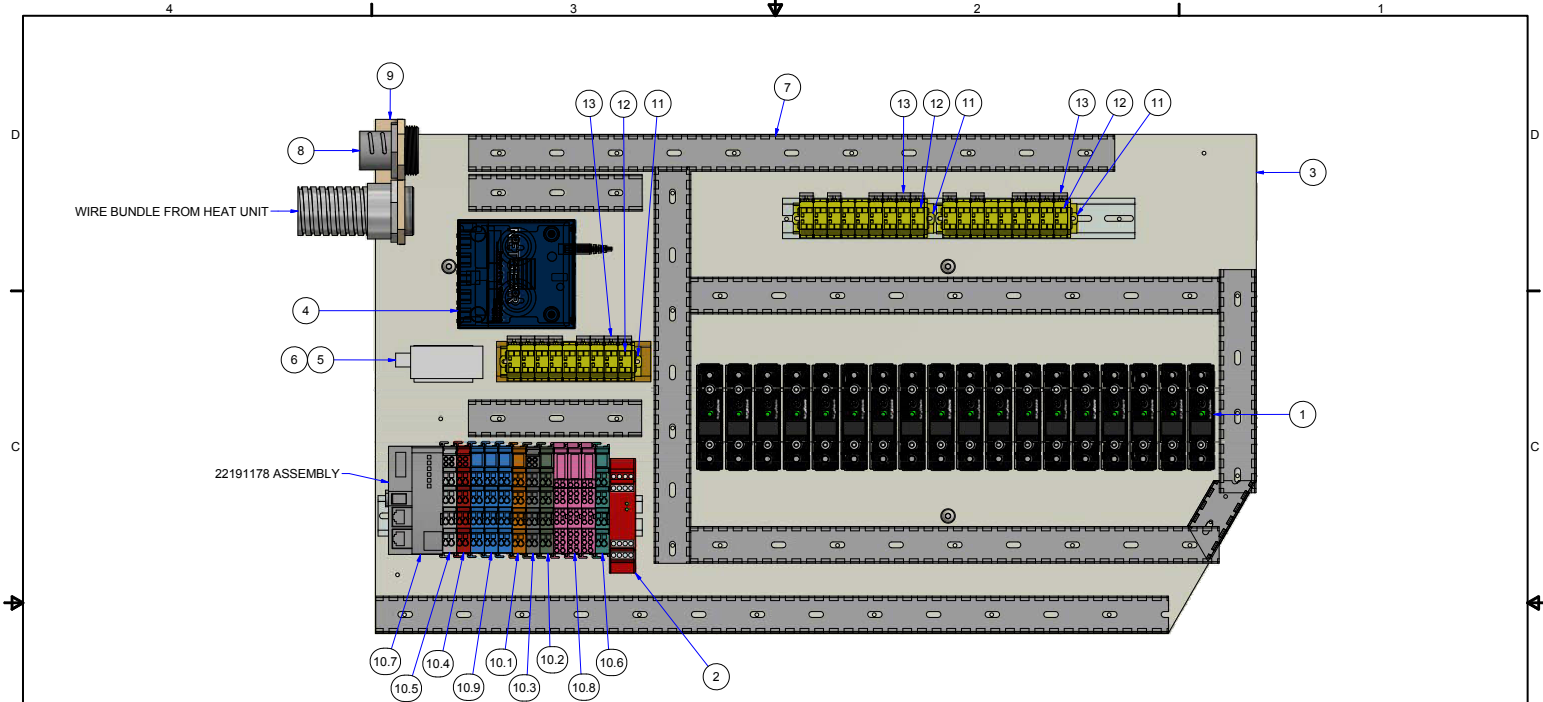

Parts List			
ITEM	QTY	PART NUMBER	DESCRIPTION
1	18	4500-0153	SOLID STATE RELAY, SPST-NO, 25A, 0-10VDC
2	1	2200-0171	CONTROLLER, SAFETY GATE MONITOR
3	1	22190814	COMPONENT PLATE_DS9100_HEATER
4	1	2025-0080	5 PORT, ETHERNET SWITCH, NETGEAR
5	1	4000-0202	AC/DC_CONVERTER_5V_15W_3A_85-264VAC
6	1	22170171	BRKT_PWR_SPLY_5V_12V_PREHEAT
7	9	2800-0116	CONDUIT_GRAY_1.12WDX1.13HT (CUT-TO-LENGTH)
8	1	2800-0303	FITTING_PANEL_MT_FLEX_CONDUIT_1-1/4
9	1	22190816	ANCHOR BRKT_CONDUIT_HEATER
10	1	22191178	DEVICE_ASSY_MODBUS_PREHEATER_DS_SERIES
10.1	1	2200-0340	MODULE_8CH INPUT_3.0MS_HIGH SIDE SWITCH
10.2	1	2200-0368	MODULE_8CH INPUT_3.0MS_HIGH SIDE SWITCH
10.3	1	2200-0392	MODULE_POWER SUPPLY_FIELDBUS_PASSIVE
10.4	1	2200-0345	END MODULE_WAGO_750 SERIES
10.5	1	2200-0358	WAGO_2CH_THERMOCOUPLE TYPE-K
10.6	1	2200-0361	MODULE_8CH INPUT_3.0MS_HIGH SIDE SWITCH
10.7	1	2200-0476	COUPLER_FIELDBUS_WAGO_24VDC_MODBUS
10.8	3	2200-0399	MODULE_FIELD SIDE_POWER CONNECTION
10.9	3	2200-0485	MODULE_8CH INPUT_3.0MS_HIGH SIDE SWITCH
11	3	2100-0258	TERMINAL ENDCAP
12	27	2100-0251	TERMINAL BLOCK_4-POS_G/YEL
13	20	2100-0259	T-BLOCK_JUMPER_2-POS

TOLERANCES UNLESS OTHERWISE SPECIFIED	
FRACTIONS	DECIMALS
X.XX	± 0.05
X.XXX	± 0.005
ANGULAR	± 0.5°
RADIUS	± 0.03 TLR

GPD Global

DESCRIPTION
PROCESS HEAT_DS9100_IR CERAM W/LIFTER

ASSEMBLY
DS9100

MATERIAL
-

DWG NO
22151020-0001

HEAT TREATMENT
-

DWG SIZE
C

DRAWN BY ALJ 5/12/2020 SHEET 3 OF 3

Known issues

Reported temperatures do not change – even in decimal place

A start up failure may have occurred if reported temperatures do not change - not even in the decimal place.

NOTE: The [Infrared camera sensor](#) (pg 36) rarely fails to start properly; however, we are working with the vendor for resolution of this issue.

To remedy the situation:

1. Power down the system per [Power off](#) (pg 11).

IMPORTANT: Power down the whole machine, not just the computer. Powering down only the computer will NOT remove power from the camera.

2. Wait 15-30 seconds.
3. Restart the system per [Power on](#) (pg 11).

Displayed image is monochromatic (or nearly so)

A start up failure may have occurred if the displayed image appears monochromatic or nearly monochromatic.

NOTE: The [Infrared camera sensor](#) (pg 36) rarely fails to start properly; however, we are working with the vendor for resolution of this issue.

To remedy the situation:

1. Power down the system per [Power off](#) (pg 11).

IMPORTANT: Power down the whole machine, not just the computer. Powering down only the computer will NOT remove power from the camera.

2. Wait 15-30 seconds.
3. Restart the system per [Power on](#) (pg 11).

Heater power on at computer boot up

Heater elements may remain in a powered condition (generating heat) if you reboot the computer (either warm or cold restart) without cycling power for the entire machine.

NOTE: If the computer is turned off or reset:

- you may not realize the above is happening and/or
- the computer loses control of the heaters.

To remedy the situation:

1. Power down the system per [Power off](#) (pg 11).

IMPORTANT: Power down the whole machine, not just the computer. Powering down only the computer will NOT remove power from the camera.

2. Wait 15-30 seconds.
3. Restart the system per [Power on](#) (pg 11).

Application window disappears

If the application window disappears with no indication of what has happened and no error messages display, it's likely the application crashed.

To remedy the situation:

1. Power down the system per [Power off](#) (pg 11).

IMPORTANT: Power down the whole machine, not just the computer.

2. Wait 15-30 seconds.
3. Restart the system per [Power on](#) (pg 11).

Glossary

Aggregated Process Value

A process variable value derived from multiple sensor inputs. Example: an infrared camera may report temperatures from multiple spots. These values are averaged to form a single aggregated process variable.

Aggregated Process Variable Maximum / Minimum

When a process variable is derived from multiple sensor values (Aggregated PV), the reported value is typically the *mean* of all sensor values. The process variable Maximum is the maximum value of the set of sensors while the process variable Minimum is the minimum value of the set of sensors.

Board Height

Distance (mm) between the conveyor rails.

Board Width

Distance (mm) along the conveyor direction of travel - the axis of motion.

Box Meter

A box meter monitors a specified *rectangular area*.

Distance

Parameter representing the amount of space between the board and the front lens of the camera is used to compensate for the following facts:

- * Radiation from the target is absorbed by the atmosphere between the board and the camera.
- * Radiation from the atmosphere itself is detect by the camera.

Emissivity

Parameter representing the measure of how much radiation is emitted from the board compared to that from a perfect blackbody of the same temperature.

Limit Low

The low value of the process acceptance range.

Limit Low Low

Limit at which damage is possible to the machine or the product. When a process value exceeds (falls below) a low low limit, the equipment reports an error and shuts itself down to prevent damage.

Limit Hi (High)

A high limit is the high value of a process acceptance range.

Limit Hi Hi (High High)

A limit at which damage is possible to the machine or the product. Typically, when a process value exceeds a high high limit, the equipment reports an error and shuts itself down to prevent damage.

Example: If an infrared camera has a maximum environmental operating temperature of 50°C (a high high limit) and the temperature of that camera reaches 51°C, the system shuts down all operation and reports an error condition.

OverBoard

The top side of the board/product.

PV

Abbreviation for Process Variable.

Power Output

The amount of power being applied to the heating elements. Expressed as *percent of full scale* where *scale* is defined as *maximum current draw* of the heating unit.

Process Limits Range

A process limit range defines a high/low numerical range. When the process value falls within this range, the process is *ready*. If the process value is outside this range, the process is *not ready*.

Process Variable

(PV) A process variable is the current measured value of a particular part of a process which is being monitored or controlled. Example: the temperature of a PCB.

Reflected apparent temperature

Parameter used to compensate for the radiation reflected in the board. If the emissivity is low and the board temperature relatively far from that of the reflected, it will be important to set and compensate for the reflected apparent temperature correctly.

Set Point

A set point is the desired value for a process variable.

Spot Meter

A spot meter monitors a specified *coordinate*.

UnderBoard

The bottom side of the board/product.