NCM5000 Controller User Guide

Version 2.0
March 29, 2019
Part No. 2200-0400M

for use with:
NCM5000 Controller - Part No. 2200-0400



prepared by GPD Global[®] Documentation Department



611 Hollingsworth Street
Grand Junction, CO, USA 81505
tel: +1.970.245-0408 • fax +1.970.245-9674
request@gpd-global.com • www.gpd-global.com

Copyright © 2019 GPD Global[®] • All Rights Reserved

Contents

Overview	1
Features	1
Part Identification	1
Controls	3
Jet and Fluid Pressure Regulator	3
Temperature Controller	3
LCD Display Functions and Selection Keys	7
Trigger Button and LED	8
Installation / Connections	8
Pneumatic System	8
Electrical Interface	9
Input / Output Connections	10
Serial Communication	12
Application Hints	13
Fluid Pressure (FP)	13
Jet Pressure (JP)	14
Refill Time	16
Dwell Time	17
Summary of Typical Parameters and Their Effects	18
Start Up Quick Reference	19
Set Up Hardware	19
Set Dispensing Parameters	22
Specifications	24
General Specifications	24
Dimensions	24
Interface Software	25
Starting NCM5000 Controller Interface Software	25
Settings Menu	25
Timing Recipes Menu	28
Programming Timing Recipes	29
DROP Mode Programming	30
LINE Mode Programming	30
Running a Program from Software	31
Commands	33
The RS-23 Interface	33
Command Format	33
Recipe Timing Commands	34
Jetting Commands	35

Heater Commands	36
Output Commands	37
Troubleshooting	38
Appendices	39
First Drop Compensation	39
Temperature Controller Security	42
Temperature Controller Settings	43
Digital Pressure Gauge	47

Safety Guidelines

- The described hardware is a resource for use in industrial environments.
- GPD Global® products are manufactured according to currently valid engineering standards and are operationally safe. Hazards may arise if handled improperly by unqualified personnel. Thorough review of operating instructions is recommended for the operating personnel.

CAUTION: The connecting cables may only be removed or attached when the NCM5000 controller is not delivering voltage to the Jet. To insure this, turn off the main power switch on the front of the NCM5000 controller.

CAUTION: Be sure to use only the main input power cord supplied with the unit. The power cord supplied with the unit supports 100/120V. If you are planning to use the unit in countries using 220/240V, please replace the main power cord with an approved TUV power cord rated for 220/240V. Be sure to change the main power input fuse from 1A to 0.5A. GPD Global® can supply the appropriate power cords and fuses.

CAUTION: Qualified personnel are persons who, due to their training, expertise and instruction, as well as their knowledge of relevant standards, provisions, accident prevention regulations and operating conditions, have been authorized by the person responsible for safety of the system to perform the required tasks and, in the process, can identify and prevent potential risks (definitions for specialists according to the VDE 105 or ICE 364).

Warranty

General Warranty. Subject to the remedy limitation and procedures set forth in the Section “Warranty Procedures and Remedy Limitations,” GPD Global warrants that the system will conform to the written description and specifications furnished to Buyer in GPD Global’s proposal and specified in the Buyer’s purchase order, and that it will be free from defects in materials and workmanship for a period of one (1) year. GPD Global will repair, or, at its option, replace any part which proves defective in the sole judgment of GPD Global within one (1) year of date of shipment/invoice. Separate manufacturers’ warranties may apply to components or sub-assemblies purchased from others and incorporated into the system. THIS WARRANTY IS EXPRESSLY IN LIEU OF ANY AND ALL OTHER WARRANTIES, EXPRESS OR IMPLIED, INCLUDING WARRANTIES OF MERCHANTABILITY OR FITNESS FOR A PARTICULAR PURPOSE.

Limitations. GPD Global reserves the right to refuse warranty replacement, where, in the sole opinion of GPD Global the defect is due to the use of incompatible materials or other damages from the result of improper use or neglect.

This warranty does not apply if the GPD Global product has been damaged by accident, abuse, or has been modified without the written permission of GPD Global.

Items considered replaceable or rendered unusable under normal wear and tear are not covered under the terms of this warranty. Such items include fuses, lights, filters, belts, etc.

Warranty Procedures and Remedy Limitations. The sole and exclusive remedy of the buyer in the event that the system or any components of the system do not conform to the express warranties stated in the Section “Warranties” shall be the replacement of the component or part. If on-site labor of GPD Global personnel is required to replace the non-warranted defective component, GPD Global reserves the right to invoice the Buyer for component cost, personnel compensation, travel expenses and all subsistence costs. GPD Global’s liability for a software error will be limited to the cost of correcting the software error and the replacement of any system components damaged as a result of the software error. In no event and under no circumstances shall GPD Global be liable for any incidental or consequential damages; its liability is limited to the cost of the defective part or parts, regardless of the legal theory of any such claim. As to any part claimed to be defective within one (1) year of date of shipment/invoice, Buyer will order a replacement part which will be invoiced in ordinary fashion. If the replaced part is returned to GPD Global by Buyer and found by GPD Global in its sole judgment to be defective, GPD Global will issue to Buyer a credit in the amount of the price of the replacement part. GPD Global’s acceptance of any parts so shipped to it shall not be deemed an admission that such parts are defective.

Specifications, descriptions, and all information contained in this manual are subject to change and/or correction without notice.

Although reasonable care has been exercised in the preparation of this manual to make it complete and accurate, this manual does not purport to cover all conceivable problems or applications pertaining to this machine.

Overview

After the NCM5000 Controller is programmed, a jet pump can be triggered manually, from a host robot, or from a PC using the RS232 interface.

Features

- Powerful single board computer and LCD display.
- Front panel keys for easily programming dispensing parameters.
- Six independent dispensing recipes can be programmed using the front panel keys or using the NCM5000 Controller Interface Software and downloaded into memory.
- Timing parameters including Refill and Dwell times can be adjusted with 0.1 msec resolution.
- Single drops, multiple drops and lines can be programmed.
- Thermal management reduces power/heat when the jet is idle.
- OEM configuration is available to interface to a PLC or custom control system.

Part Identification

Front View



1	power switch	turns on/off device power
2	fluid pressure gauge	displays fluid delivery pressure
3	LCD display	displays the program parameters
4	trigger LED	turns on when dispensing
5	trigger switch	activates current recipe displayed on LCD once
6	jet pressure gauge	displays jet actuation pressure
7	jet pressure regulator	regulates the jet actuation pressure
8	temperature controller	controls the temperature of the dispensing nozzle
9	key pad	moves cursor on LCD display and changes the parameter values
10	fluid pressure regulator	regulates the fluid delivery pressure
11	air switch	turns on/off the fluid delivery pressure
NOTE: Some models have an additional RS-232 connect on the Front Panel		

Rear View



12	air inlet	Port should be connected to source pressure with a 6 mm Ø hose
13	jet pressure outlet	Port provides air pressure for the jet dispenser and should be connected with a 6 mm Ø hose
14	fluid pressure outlet	Port provides fluid delivery air pressure and should be connect to the fluid syringe with a 4mm Ø hose
15	LCD contrast adjustment	The adjustment changes the contrast level on the LCD display by rotating the switch with a small screw driver
16	AC connector with fuses	Power is supplied here and two fuses are required
17	RS-232C	Serial communication connector
18	jet connector	Sends output trigger signals for the dispensing jet and heater settings. This connector should be connected to the jet electrical connector using the approved cable supplied with the system.
19	I/O connector	Used to trigger the dispensing recipes and outputs, busy flag, and error signals from the pressure gages and heater controller

Controls

Jet and Fluid Pressure Regulator

The NCM5000 Controller has integrated air regulators which control the pressure to the Jet and the Fluid supply. Two digital gages indicate the pressure levels. An air switch allows you to turn the Fluid Pressure off - this is very convenient when changing fluid or cleaning the jet.

IMPORTANT: The Jet Pressure must be above 0.241 MPa (35 psi) for the Jet to operate correctly.

Temperature Controller

The model of temperature controller used varies by NCM5000 pump model:





How Used	Pump Type	Temperature Controller Model
Stand-alone	Island Series SimpleCoat SimpleCoat TR	Love Controls Temperature Controller (pg 3)
	Legacy systems	Omega Temperature Controller (pg 4)
System Integration	MAX Series DS Series	Watlow Temperature Controller (pg 6)

Love Controls Temperature Controller

The HOME display is the normal display while the control is operating. If no errors or functions are active, the HOME display indicates the Process Variable being measured on the top display and the Set Variable on the bottom display.

To adjust heat (to change the variable temperature set point):

1. Power on the NCM5000 Controller. The temperature controllers powers up with the NCM5000 Controller.
2. Adjust the temperature set point to desired value using these keys:

Key	Key Label	Description
	INDEX	Press to advance the display to the next menu item.
	UP ARROW	Increments a value or changes a menu item. Press during Operation Mode to increase set point value.
	DOWN ARROW	Decrements a value or changes a menu item. Press during Operation Mode to decrease set point value.
	ENTER	Stores value or item change. If not pressed, the previously stored value or item is retained. During Operation Mode : <ul style="list-style-type: none"> • Press to switch to Regulation Mode, or • Press and hold more than 3 seconds to switch to Initial Setting Mode. During Regulation Mode or Initial Setting Mode : <ul style="list-style-type: none"> • Press to return to Operation Mode.

Omega Temperature Controller

NOTE: The default factory settings are available here: [Temperature Controller Settings](#) (pg 43).

The main menu of the temperature controller displays the present temperature (PV) on the top line, and the set point temperature (SV) on the bottom line of the display.



To change the set point temperature, use the UP/DOWN arrows to increase/decrease the temperature. For example, to change SV from 20 to 45 degree, use the UP arrow to increase the SV value until it is at 45, then press the ENTER key to save the change.



To turn ON the heater:

1. Press the INDEX key until you see the Run-Stop Output Control screen (**r-5**) on the top line of the display.
2. Use the arrow key to select **run** setting to turn ON the heater.
3. Then press the ENTER key to save the change. Now the heater is turned ON.
4. Press ENTER key again to return to the main screen display.

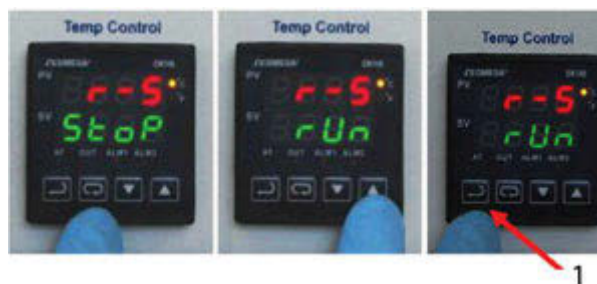

To turn OFF the heater:

1. Press the INDEX key until you see the Run-Stop Output Control screen (**r-5**).
2. Use the arrow key to select **Stop** setting to turn OFF the heater.
3. Then press the ENTER key to save the change. Now the heater is turned OFF.

4. Press ENTER key again to return to the main screen display.



NOTE: Refer to Heater Options under [Settings Menu](#) (pg 25) for details on how to change the heater settings from the NCM5000 program. See [Temperature Controller Settings](#) (pg 43) for the technical specifications.

Watlow Temperature Controller

NOTE: The default factory settings are available here: [Temperature Controller Settings](#) (pg 43).

To adjust heat (to change the variable temperature set point):

1. Power on the NCM5000 Controller. The temperature controllers powers up with the NCM5000 Controller.
2. Activate the temperature controller within the software by turning on the applicable LiftTempCtrlIn input/output in the ioView window.

NOTE: Activation is required to send a control signal which starts the heating process.

3. Adjust the temperature set point to desired value:
 - a. Press the ADVANCE key.
 - b. Using the UP and DOWN keys, set a value for temperature set point.
 - c. Press the INFINITY key. This returns you to the “home” display.

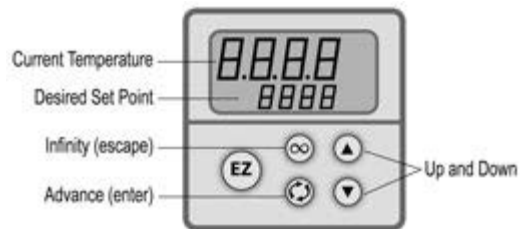

NOTE: If the desired set point displays as a large negative value, this indicates that the controller needs to be activated within the software Refer to [Step 2](#) above.

LCD Display Functions and Selection Keys

There are 8 settings available on the main LCD menu. The UP/DOWN keys are used to increment the values in the settings. The LEFT/RIGHT keys are used to select the settings. The selected setting is indicated by a blinking cursor.

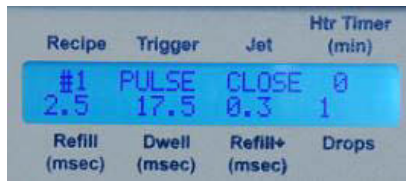

Recipe	Up to 6 timing recipes can be saved in the controller
Trigger	Choose between PULSE and LEVEL for Trigger Mode
Jet	Use this option to CLOSE or OPEN the Jet valve
Htr Timer (min)	Setting a value <i>n</i> greater than zero will cause the controller to turn off the Heater after <i>n</i> minutes of idle time
Refill (msec)	Specify the Refill Time in msec for Recipe # <i>n</i>
Dwell (msec)	Specify the Dwell Time in msec for Recipe # <i>n</i>
Refill+	Equivalent to the AddXX ms in the Timing Recipes menu (Timing Recipes Menu (pg 28)). Also refer to First Drop Compensation (pg 39).
Drops	Specify the number of drops to be repeated. For example, if you want a single drop per trigger signal, enter 1. If you want 10 drops to be dispensed per trigger signal, enter 10.

NOTE: To set the additional parameter **Refill ++**, press the LEFT and RIGHT keys *simultaneously* below the LCD display and the following screen will appear on the LCD display. Refer to First Drop Compensation.



The **RCP:** option selects the timing recipe from #1 to #6. The **AFTER** and **REFILL++** values are equivalent to the **Add XX msec after YY seconds** in the Timing Recipes menu [Timing Recipes Menu](#) (pg 28).

Once you make the changes, you should press the LEFT and RIGHT keys *simultaneously twice* to accept the new settings, and the LCD display will return to the main menu. Note that on the first press, the LDC display will change to the RS232 menu (see [Serial Communication](#) (pg 12) and then to the main menu on the second press.

IMPORTANT: If you make changes to values using the front panel display, the changes will not be reflected back to the NCM5000 Controller program. Also, the values can be overwritten each time you start the NCM5000 program. The warning will be displayed. Write down your changes and then enter them into the software to synchronize.

Trigger Button and LED

Trigger Switch

Press the switch to immediately trigger the current recipe # displayed on the LCD screen. If multiple drops are specified in the recipe #, then multiple drops will be dispensed.

Output

The Output light is on when the Jet is firing so you can verify a signal was sent to the Jet. The light is off when the Jet is in idle state.

Installation / Connections

Pneumatic System

Connect an independently regulated and filtered main air source to the rear of the NCM5000 Controller. The air must be clean and dry, and a maximum pressure of 0.620 MPa (90 psi). Normal JET air operation is usually between 0.276-0.414 MPa (40-60 psi).

Connect the jet air tube to the JET connector on the rear of the controller using a 6 mm OD tube.

Figure 1: Pneumatic System

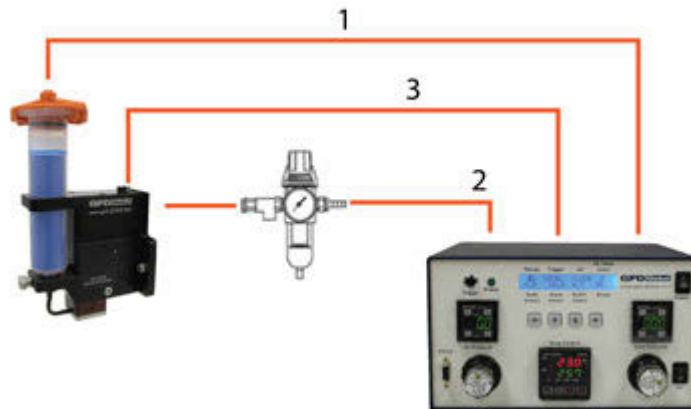

1	fluid pressure	4 mm OD tube
2	air in	6 mm OD tube
3	jet	6 mm OD tube

The FLUID pressure is regulated separately from JET pressure. Maximum fluid pressure is 0.276 MPa (40 psi); however, normal operation is usually between 0.034-0.207 MPa (5-30 psi). Pressure variations in the fluid pressure source can adversely affect the drop size. The digital pressure gauges are factory set to pressure in PSI (pound/in²). To change the units and make other adjustments like error conditions, refer to [Digital Pressure Gauge](#) (pg 47).

CAUTION: It is imperative that the air supplied to the NCM5000 is clean and dry, free from debris and water. A 40 micron filter and a water separator are highly recommended to keep the air debris free. If the air is not clean and dry, serious damage can occur to the air solenoid valves. The maximum allowable supply air pressure is 0.620 MPa (90 psi).

Electrical Interface

There are three cable connections on the rear of the NCM5000 Controller: RS-232, Digital I/O, and Jet. All three cables have different connectors, so it is not possible to make improper connections to the controller when using the standard cables supplied.

CAUTION: Be sure that all power is off when connecting and disconnecting any cable to the NCM5000 Controller.

The NCM5000 Controller Interface Software software requires an RS-232C communication interface with the NCM5000 Controller. If you do not have an RS-232C port, use a USB to RS-232C converter cable with the drivers that come with the cable. An RS-232C to USB cable and drivers can be supplied.

Figure 2: Electrical Interface

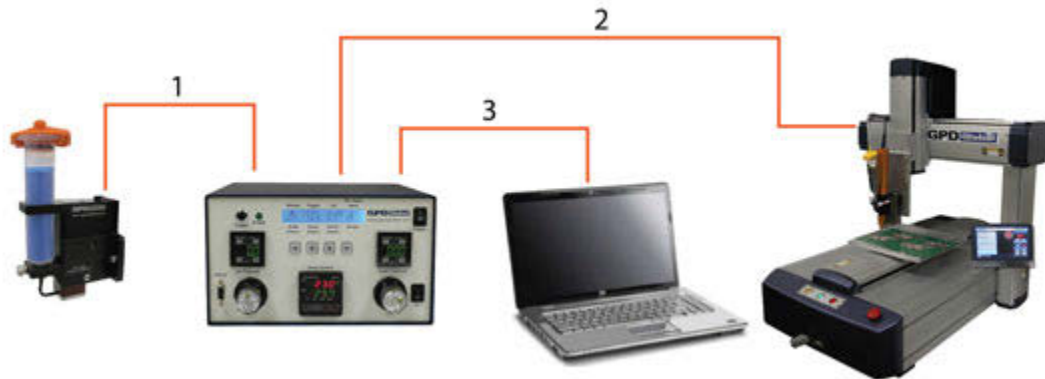

1	jet cable
2	I/O cable
3	RS-232C cable

The Jet cable is a high-density HD-15 pin cable and should be attached directly to the NCM5000 Pump and NCM5000 Controller.

The I/O cable is used by the robot controller to trigger the NCM5000 to fire a sequence of drops that were downloaded into the NCM5000 Controller. The I/O cable should be connected directly to host robot controls. A Male DB-26 connector is required to mate with the I/O cable.

The NCM5000 Controller has an internal nonvolatile memory that retains the jet parameters that were downloaded into the controller. The controller provides 6 TTL trigger lines to control the operations of the jet.

Input / Output Connections

Pin assignments of the standard 26 pin I/O connector are noted in [I/O Pin Assignments & Relationships](#) (pg 11). A standard 5 foot I/O cable is supplied with the NCM5000. The I/O is configured for the inputs to be pulled down to GND (pin 9 or 14). When the specific input is triggered, the NCM5000 Controller will activate the corresponding preprogrammed Recipe # shown.

Example A:

Connect pins 4 and 9 to activate Recipe 4. 

Example B:

Connect pins 1 and 9 to activate Recipe 1. 

Figure 3: Connectors & Pin Locations

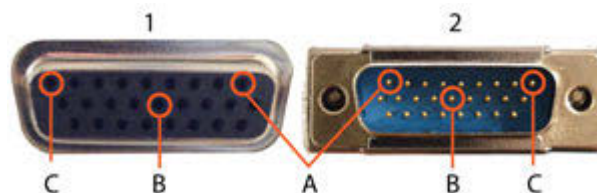

1	NCM5000 Controller connector
2	Machine/Robot connector
A	Pin 1 location
B	Pin 14 location
C	Pin 9 location

I/O Pin Functions

- Pins 1 through 6 of the I/O cable are outputs from the robot to the NCM5000 Controller. They can be TTL outputs capable of sinking 2 mA of current, or they can be relay contacts.
- Pin 7 outputs a busy status flag from the NCM5000 Controller to the robot.
- Pin 8 is an external interrupt used to remotely stop a dispensing program.
- Pins 9, 14 are Isolated Ground.
- Pins 18-26 are alarms from the heater and pressure sensors.

~ continued ~

I/O Pin Assignments & Relationships

INPUTS

Pin	NCM5000
1	Recipe 1
2	Recipe 2
3	Recipe 3
4	Recipe 4
5	Recipe 5
6	Recipe 6
8	External Interrupt*
9	GND
14	GND

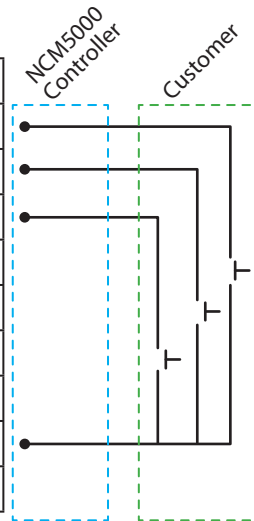

*Stop the pump if it is dispensing

OUTPUTS

Pin	NCM5000
7	Pump is running
9	GND
14	GND
18	Heater Alarm Common
19	Fluid Pressure Alarm Common
20	Lower Pressure Limit OK
21	Over Pressure
22	Jet Pressure Alarm Common
23	Lower Pressure Limit OK
24	Over Pressure
25	Lower Temperature OK
26	Over Temperature

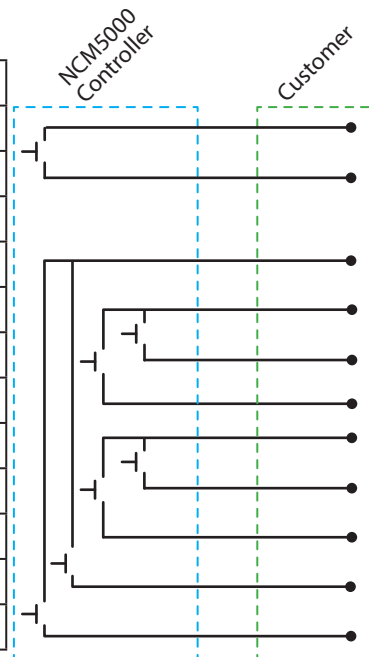

Serial Communication

RS232: Some models have a serial port DB 9P Female connector located on the front panel. You can use a USB to Serial Adapter cable to connect your PC to the controller. You simply connect the USB Plug end of the cable into your PC USB port, and connect the Serial DB9 plug of the cable to this RS232 port. The default settings for the RS232 data interface are as follows:

CTS ON for hardware handshake
 Baud Rate - 57600
 Parity – NONE
 Data Length - 8BIT

To change the default RS232 settings, press the LEFT and RIGHT keys *simultaneously twice* and the following settings will appear on the LCD display.



You can use the LEFT/RIGHT keys to move from one selection to another on the display, and the UP/DOWN keys to change the selected setting. The selected setting will be indicated by a blinking cursor.

The CTS state is either ON or OFF. Set CTS to ON if you wish to use hardware handshake. You can select 57600, 19200, 9600 or 4800 for Baud Rate. For Parity, you can select NONE, EVEN or ODD. For Data Length, you can select either 8BIT or 7BIT.

Once you make the changes for the RS232 interface, you should hold the LEFT and RIGHT keys *simultaneously* to accept the new settings. The LCD display will return to the main menu.

IMPORTANT: Remember to check the RS232 settings in the NCM5000 Controller program. The settings in the controller should be the same as the settings in NCM5000 program ([Settings Menu](#) (pg 25)). The NCM5000 program and the controller will not be able to communicate with each other when they have different RS232 settings.

Application Hints

- [Fluid Pressure \(FP\)](#) (pg 13)
- [Jet Pressure \(JP\)](#) (pg 14)
- [Refill Time](#) (pg 16)
- [Dwell Time](#) (pg 17)

Fluid Pressure (FP)

Fluid Pressure is an important jet parameter. The fluid reservoir (the syringe) must supply enough fluid to the jet chamber to generate clean drop formation. The criterion is that the fluid must flow out of the nozzle freely when you open the jet. As a general rule, a higher fluid pressure is more desirable than lower pressure; however, the material rheology has a big effect on how the fluid flows out the nozzle.

Table 1: Typical Flow Patterns - when Jet is Open & Fluid Pressure is applied



Stream

The first example is a material that flows freely and forms a stream. Many low viscosity epoxies will form a stream. For example a low viscosity underfill like Hysol 3800 and Namics 8443 will form a stream, while a low viscosity UV epoxy like EMI 3553 will not. Set the Fluid Pressure to the minimum value that allows a clean stream to form.

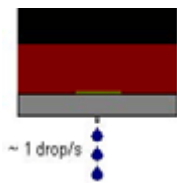

Drop

Some materials form drops of fluid rather than a stream. These fluids tend to be higher viscosity and will not stream. A good rule of thumb is to set the Fluid Pressure so you have about 1 drop/sec. Many highly filled underfill epoxies exhibit this flow pattern. Examples of this type of fluid are Namics 8439 and 8410.

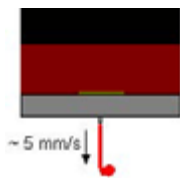

Curl

Other fluids will form a stream, but are "stringy" enough that they will curl at the end of the stream. A good example of this behavior is Loctite Chipbonder 3621. A good rule of thumb is to set the Fluid Pressure so that the stream flows cleanly and don't worry about the curl at the end.

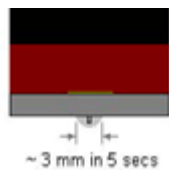

Pool

Another type of fluid will not form a drop or a stream. These fluids are very "stringy" and will form a "pool" of fluid around the nozzle tip very similar to accumulation that occurs when a jet is not performing correctly. A good rule of thumb is to set the Fluid Pressure so that a 3mm pool forms in 5 seconds. UV epoxies like EMI 3553, and 1768 are examples of this type of flow.

Jet Pressure (JP)

Jet Pressure is the key parameter for drop quality and is very important for accumulation-free jetting. Accumulation is a condition where the jet does not break off cleanly into a drop, thereby leaving material to build up on the nozzle tip. There is a minimum Jet Pressure setting necessary so the exit velocity of the jet allows clean break off. After the minimum Jet Pressure is reached, increasing the Jet Pressure can generate too forceful a jet and produce unwanted splashes, i.e., drop splatter. Also, smaller drops, called satellites can form with too high of a Jet Pressure setting.

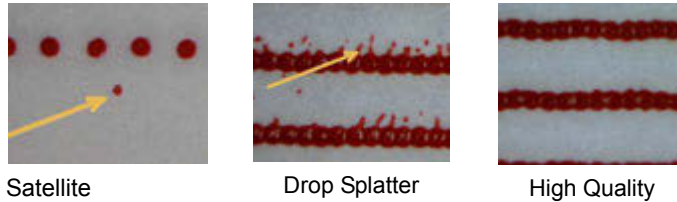

Satellite

Drop Splatter

High Quality

There is no magic number for the Jet Pressure because it is so dependent on the viscosity and surface tension of the material.

The best technique for establishing Jet Pressure:

1. Start with a midpoint and adjust the Jet Pressure for the best drop quality without accumulation. In general, 0.310 MPa (45 psi) is a good starting point for Jet Pressure.

If the jet does not break off cleanly, increase the Jet Pressure. A symptom of poor break off is accumulation.

Sometimes reducing the Jet Pressure can eliminate accumulation if the jet velocity is too high and many satellites are formed. In this case, lower the Jet Pressure and see if the accumulation goes away. The jet requires a minimum of 0.241 MPa (35 psi) to function correctly. You should not run below this value.

2. If you increased the Jet Pressure as high as 0.45 MPa (65 psi) and still have accumulation, try a higher Temperature.

Table 2: Typical Pressure Settings

Fluid Type	Viscosity (cps)	Nozzle Size (µm)	Temp (° C)	Jet Pressure (MPa)	Speed (Hz)	Drop Weight (µg)
Loctite 3621	50K	125	45	0.35	100	32
EMI 1768-VTG	65K	125	45	0.35	100	42
EMI 3553	1K	110	40	0.30	270	21
EMI 1748S-HTG-HV3	400K	125	45	0.30	200	26
Norland 123 TKHGA	200K	125	50	0.45	200	38
Alpha WS-619	100K	125	50	0.35	200	35
Namics 8439	50K	150	55	0.34	250	50
Namics 8410	60K	150	55	0.34	250	50
Hysol 3800	300K	150	35	0.33	200	80

Refill Time

The Refill Time is a major factor in determining the drop volume. Refill Time is the “open” time of the jet when fluid flows into the orifice. It is important to allow enough time for the fluid to flow into the nozzle, otherwise the jet will be “starved”. If there is too much fluid flowing into the nozzle, the drop will be too large to jet and accumulation will occur. If the drop volume is too high, reduce the Refill Time; if too low, increase the Refill Time. If you are not able to achieve the proper drop volume, change the Nozzle Size or the Fluid Pressure.

The speed of the jet in Hertz (Hz) is defined as:

$$\text{Drop Speed (Hz)} = 1 / (\text{Refill} + \text{Dwell}) \text{ seconds}$$

$$50 \text{ Hz} = 1 / (.005 + .015)$$

$$100 \text{ Hz} = 1 / (.003 + .007)$$

$$200 \text{ Hz} = 1 / (.002 + .003)$$

$$303 \text{ Hz} = 1 / (.0016 + .0017)$$

NOTE: The minimum refill time is 1.7 msec and is dependent on the fluid. A shorter refill time will probably fail to produce drops.

- At low speeds, < 50 Hz, the Refill Time should be a minimum of 3 msec. As the speed increases, > 100 Hz, reduce the Refill Time to 2 msec.
- At high frequency, > 250 Hz, use a refill of 1.7 msec.

Many viscous fluids tend to “shear thin” when operating at high speed, and because of shear thinning, the drop volume sometimes increases with speed for a given refill time.

Table 3: Typical Refill Times for Various Fluids

Fluid Type	Viscosity (cps)	Nozzle Size (µm)	Temp (° C)	Refill (ms)	Dwell (ms)	Speed (Hz)	Dot Weight (µg)
Loctite 3621	50K	125	45	2.0	8.0	100	32
EMI 1768-VTG	65K	125	45	2.0	8.0	100	42
EMI 3553	1K	110	40	1.7	2.0	270	21
EMI 1748S-HTG-HV3	400K	125	45	2.0	3.0	200	26
Norland 123 TKHGA	200K	125	50	5.0	45.0	200	38
Alpha WS-619	100K	125	50	2.0	3.0	200	35
Namics 8439	50K	150	55	2.3	1.7	250	50
Namics 8410	60K	150	55	2.3	1.7	250	50
Hysol 3800	300K	150	35	2.0	3.0	200	80

Dwell Time

The minimum Dwell Time is the time needed for a drop to be ejected from the nozzle tip after the diaphragm hits the nozzle seat. The Dwell Time is generally not important if you are dispensing in "Drop Mode". Drop Mode is when you jet a single drop of fluid, move to the next position and jet another drop. The motion of the robot will always take longer to move from position to position than the jet will need for the drop to eject; however, in "Line Mode or Level Mode", the Dwell Time is important.

The speed of the jet is determined by the sum of the Refill and Dwell Time. Often, a faster jet speed produces less accumulation. Generally, you want to make the Dwell Time as small as possible with the minimum being 1.5 msec. A good rule of thumb is to start with a Dwell Time of 3-8 msec.

Settings are dependent on material. For example, a very thick, stringy material like Norland 123 TKHGA cannot run faster than 20 Hz, while a thin material like Hysol 3800 can run at 300 Hz. When in Line/Level Mode, the speed of the jet is used to calculate the velocity of the robot.

$$\text{The Robot Velocity } V \text{ (mm/sec)} = \Delta X(\text{mm}) / \Delta T(\text{sec})$$

Where:

ΔX = the drop spacing

ΔT = (Refill Time + Dwell Time)

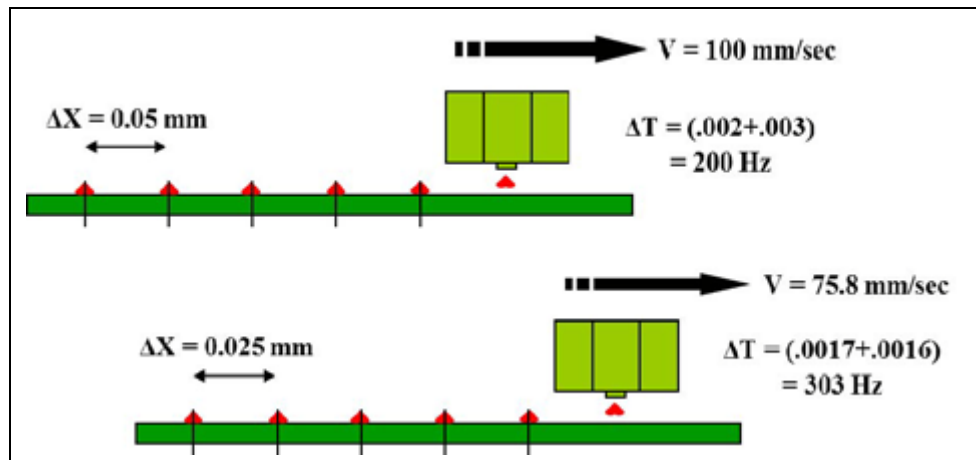

Summary of Typical Parameters and Their Effects

Table 4:

Parameter	Effects		
Nozzle Size	Nozzle Size (µm)	Drop Weight (µg)	Drop Diameter (µg)
	125	20-40	0.3-0.7
	150	50-80	0.6-1.0
	200	90-120	0.8-1.4
Temperature	<ul style="list-style-type: none"> • It lowers the viscosity of the fluid, and makes it easier to flow. • Higher temperature allows a cleaner break off and less accumulation. • “Stringy” materials require higher temperature. • However, too high a temperature produces splashes. 		
Fluid Pressure	<ul style="list-style-type: none"> • Higher Fluid Pressure produces bigger dots. • Thicker fluids need higher Fluid Pressure. Use the combination of Temperature and Pressure to control the Flow Rate. • Good Flow Rate is important for reliable jetting. 		
Jet Pressure	<ul style="list-style-type: none"> • Jet Pressure is the key parameter to get good Jet Velocity. • Good Jet Velocity produces clean jetting without accumulation. • Minimum JP is 0.241 MPa (35 psi). Maximum JP is 0.45 MPa (65 psi). • If the jet accumulates, increase JP. However, too high a JP can produce satellites. • If JP is as high as 0.45 MPa and you still have accumulation, you should increase the Temperature. • If JP is as high as 0.45 MPa and the jet won’t break off, you might need to increase the IMPact Gap. • Higher JP will decrease the dot weight, and lower JP will increase the dot weight. If you want to maintain the same dot weight, you will need to change the FP accordingly. 		
Refill Time	<ul style="list-style-type: none"> • Longer Refill Time produces bigger dots. • The combination of Fluid Pressure and Refill Time control the dot size. • 2 msec is a good starting point. Increase or decrease as needed. • Decrease Refill Time if you need to go faster than 250 Hz. • Minimum refill time is 1.7 msec 		
Dwell Time	<ul style="list-style-type: none"> • Dwell Time has no effect in DOT mode. • The Dwell time controls the jetting speed in LINE or LEVEL mode. • Higher jetting speed produces higher Jet Velocity, and cleaner jetting. • $Speed = 1 / (Refill + Dwell)$ For example: $100 \text{ Hz} = 0.002\text{msec} + 0.008 \text{ msec} = 0.003\text{msec} + 0.007$ $200 \text{ Hz} = 0.002\text{msec} + 0.003 \text{ msec} = 0.003\text{msec} + 0.002$ $303 \text{ Hz} = 1.7 \text{ msec} + 0.0016 \text{ msec}$ 		

Start Up Quick Reference

- [Set Up Hardware](#) (pg 19)
- [Set Dispensing Parameters](#) (pg 22)

Set Up Hardware

1. Inspect the Nozzle Plate for cleanliness.

IMPORTANT: It is important to inspect the nozzle plate for debris before mounting it onto the Jet. If the nozzle plate is not clean, it could affect the dispensing quality, or worst case, could plug the nozzle orifice. Refer to *Cleaning the Jet* in the *NCM5000 Pump User Guide* (PN 22293180M).

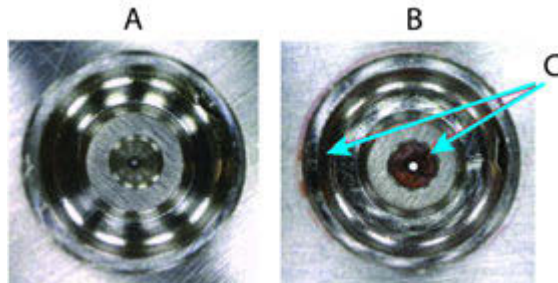

A	example of clean nozzle
B	example of dirty nozzle
C	fluid residue

2. Turn on the Air (set to “0” position).



3. Turn on the Controller by setting the Power switch to the “1” position.



4. Set the Jet Pressure to the value dictated by your application.
 - If unclear, consult [First Drop Compensation](#) (pg 39).
 - The default pressure unit is MPa (1 MPa = 145 psi.)
 - If you can not turn the knob, pull it out to unlock it.
 - First, turn the knob down to 0.100 below the set value. Then, turn up slowly until it reaches the desired value.
 - Adjustment to +/- 0.005 MPa is acceptable.
 - If you overshoot the value, turn it back down below the set value and always “turn up to” the set value.



- Press the RIGHT ARROW key and move the blinking cursor to the Jet position.



- Toggle the UP ARROW key to OPEN.



- Align the Diaphragm as shown. Gently press the diaphragm into the rectangular grooves until it is firmly in place.

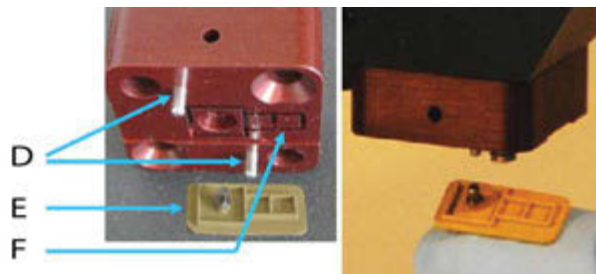

D	alignment pin
E	diaphragm
F	rectangular groove

- Align the Nozzle Plate to the alignment pins on the Heater Block, with the Fluid Barb facing the front.

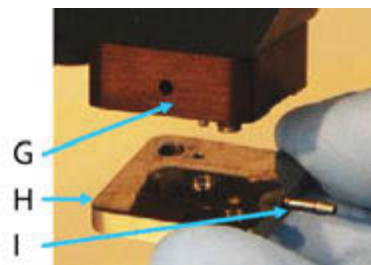

G	heater block
H	nozzle plate
I	fluid barb

- Tighten the two embedded screws with a 3 mm hex driver until finger tight. (Add ¼ turn once you feel the screws touch the bottom.) Do not over tighten as it is possible to strip the screws.



- Close the Jet before you install the Fluid Syringe.

Recipe	Trigger	Jet	Htr Timer (min)
#1	PULSE	LOSE	0
2.5	7.5	0.3	100
Refill (msec)	Dwell (msec)	Refill+ (msec)	Drops

- Insert the Feed Tube into the syringe and insert a syringe spacer ring if the syringe is smaller than 30 cc. Slip the feed tube onto the barb end of the nozzle plate and install the receiver head.

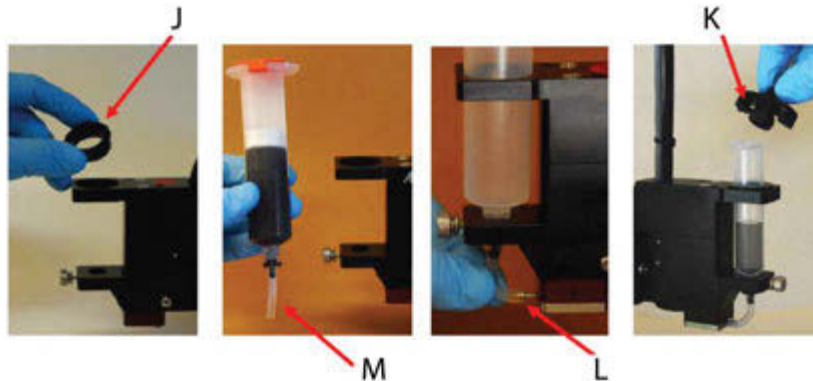

J	spacer ring
K	receiver head
L	nozzle plate barb
M	feed tube

Set Dispensing Parameters

1. Refer to [Jet Pressure \(JP\)](#) (pg 14) through [Summary of Typical Parameters and Their Effects](#) (pg 18) for reference to values for Dispensing Parameters for various fluids.
2. Turn on the heater and wait 10 minutes for the temperature of the nozzle to be stable.

You can turn on the heater using the software or the controller front panel. Refer to the [Temperature Controller](#) (pg 3) on how to turn on the heater from the software or step through the following procedure to turn on the heater from the controller front panel.

- a. Press the INDEX button to show the status.

‘ Stop ’ = heater is on
 ‘ run ’ = heater is off



- b. Press the UP button to turn on the heater.
- c. Press the ENTER button to accept the change.

NOTE: The software does not automatically communicate the settings to the controller. If you set the temperature in the software, then “Download” the recipe to the controller.

3. CLOSE the Jet before turning on the Air switch.

Recipe	Trigger	Jet	Mix Timer (min)
#1	PULSE	CLOSE	0
2.5	7.5	0.3	100
Refill (msec)	Dwell (msec)	Refill+ (msec)	Drops

4. Turn on the Air switch to the “1” position.
5. OPEN the Jet to let the fluid in the syringe to flow into the Nozzle Plate. This process is called “to Prime” the Jet.

Recipe	Trigger	Jet	Mix Timer (min)
#1	PULSE	OPEN	0
2.5	7.5	0.3	100
Refill (msec)	Dwell (msec)	Refill+ (msec)	Drops

6. Dispense Sample Dots
 - a. Set the Recipe # to what you wish to dispense.



The image shows a digital display with a blue background and white text. The display is organized into a grid with four columns and three rows. The first row contains labels: 'Recipe', 'Trigger', 'Jet', and 'Mr. Timer (min)'. The second row contains values: '#1', 'PULSE', 'LOSE', and '0'. The third row contains values: '2.5', '7.5', '0.3', and '100'. Below the grid, there are four labels: 'Refill (msec)', 'Dwell (msec)', 'Refill (msec)', and 'Drops'.

Recipe	Trigger	Jet	Mr. Timer (min)
#1	PULSE	LOSE	0
2.5	7.5	0.3	100
Refill (msec)	Dwell (msec)	Refill (msec)	Drops

NOTE: Note: when running a recipe from the software, this is ignored. When pressing the “Trigger Button” the recipe on the display is used.

7. Press the Trigger Button to run the Recipe. Place a substrate under the nozzle to observe the quality of the drops that come out. Repeat this 4 to 5 times to ensure the jet is properly primed.
8. Observe the Nozzle Tip to verify if it is clean. The tip should be clean without any fluid clinging on the edge of the tip. If it is not clean, the temperature may not be stable, or the jetting parameters are set incorrectly. Refer to [Specifications](#) (pg 24) if this problem persists.

Specifications

General Specifications

Size	254.0 mm W x 152.5 mm H x 341.4 mm D (10.00" W x 6.00" H x 13.44" D)
Weight	3200 g (7.05 lbs)
Recipes	6 independent recipes, manual or remote triggers
Nozzle Heater	Heating to 70° C (158 F°) Programmable shutoff timer 2 alarms for process control
Interface	RS-232 Serial Port LCD Display with Keypad
Input/Output:	26 pin DB connector, digital inputs pulled to GND TTL level triggers
Operating Temperature	15 C° to 50° C (59 F° to 122 F°)
Input Power	100-240 VAC, 50/60 Hz
Input Pressure - maximum	0.6 Mpa (90 psi)
Software	Windows XP, Vista, Windows 7 and Windows 8 Fluid tables with parameters Programmable drop recipes

Dimensions

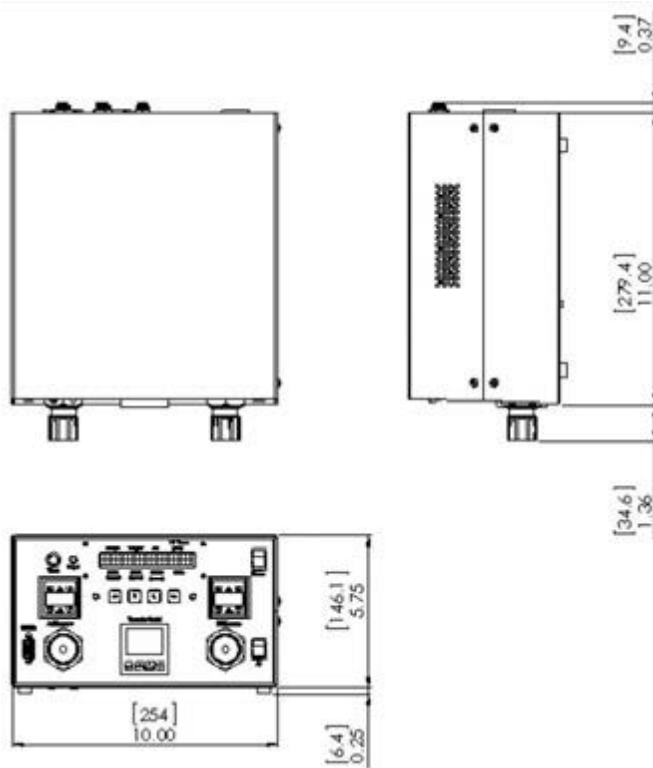

Interface Software

Starting NCM5000 Controller Interface Software

1. Connect the RS-232C cable from the PC to the controller, and connect jet air lines and jet cable to the controller. Turn on the controller and set the Jet Pressure to 0.276 MPa (40 psi).
2. Run the NCM5000 Controller Interface Software by clicking on the GPDNCM5000 entry in the Start Programs menu. You can also create a shortcut for this program.
3. On startup, the NCM5000 Controller Interface Software program will poll the NCM5000 Controller and automatically establish the RS-232C port and connection. A “Failed to find COM port for Controller” message will appear if the program cannot establish communication with the controller. If this message displays, check the RS-232 cable to make sure the connection between the PC and the controller is done properly (see [Settings Menu](#) (pg 25) for RS-232C settings).
4. The **Settings** menu will display. Check to see that the Controller Status (11) indicates: **Ready** and the Jet button on the Valve Status (1) bar is **Red**. The controller program is now enabled and ready to go.

Settings Menu

The options available from the Settings Menu:

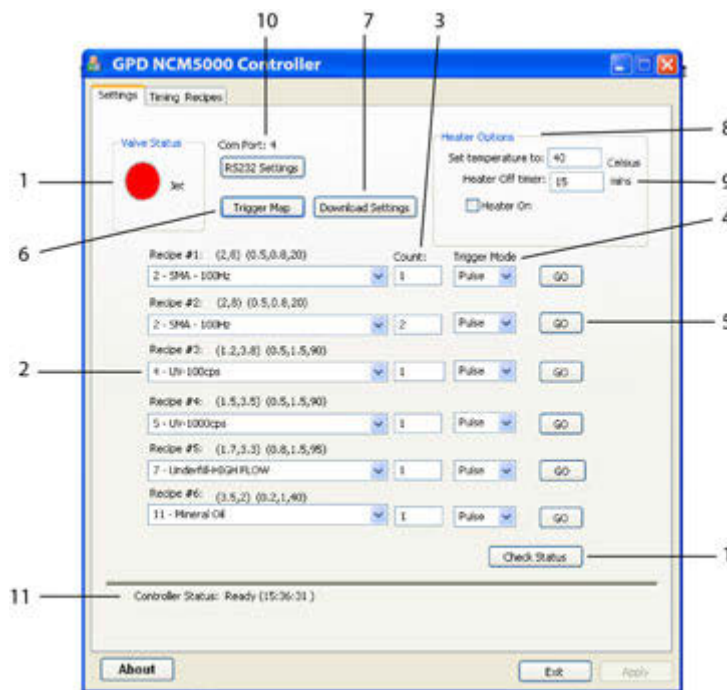

1	Valve Status	You can turn the Jet valve ON or OFF by clicking the large indicator button (RED = ON, BLUE = OFF). The Jet valve is ON by default at startup. When the button is RED, the Jet valve is activated and it will block the fluid flow. If the button is BLUE, the Jet valve is OFF and fluid will flow freely. Generally, the user should rarely have to activate the valve manually.
---	--------------	--

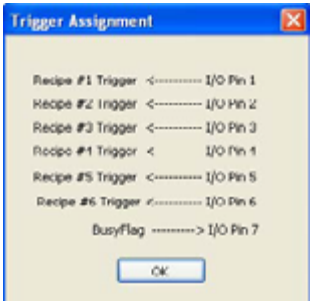
2	Recipe #1 to Recipe #6	<p>You can program up to six recipes for your controller. Each recipe consists of Refill Time, Dwell Time, and “first drop” adjustment times for Refill (see First Drop Compensation (pg 39)), number of drops to dispense, and the trigger mode.</p> <p>A pull down menu is located below each Recipe #. When the pull down menu is clicked, the Recipe List that you configured in the Timing Recipes menu (see Timing Recipes Menu (pg 28)) is displayed. Click on the arrow and chose one recipe entry from the list.</p> <p>For example, if you choose SMA-100Hz for Recipe #1, a caption of (2, 8) (0.5, 0.8, 20) appears next to it. The first bracket shows a refill time of 2 msec and dwell time of 8 msec. The second bracket shows that 0.5 msec will be added to the refill time for the first drop, and 0.8 msec will be added to the first drop if the idle time is greater than 20 seconds.</p>
3	Count	<p>You can specify the number of drops for the corresponding recipe. For example, if you want to do a single drop of Recipe #1, SMA 100Hz, specify 1 in the Count. If you want multiple drops then chose a number greater than one as shown for Recipe #2.</p> <p>Refer to DROP mode programming (see DROP Mode Programming (pg 30)) and LINE mode programming (see LINE Mode Programming (pg 30)) for how to use the Count value to set the dispensing mode.</p>
4	Trigger Mode	<p>The Trigger Mode can be either PULSE or LEVEL. In the PULSE mode, the number of drops to dispense is specified in the Count entry. For example, a count of 5 and a PULSE Trigger Mode set in Recipe #1 will cause the jet valve to dispense 5 drops when the controller receives a falling edge (high to low) signal from Recipe #1 Trigger.</p> <p>When the Trigger Mode is set to LEVEL, the jet will dispense drops nonstop as long as the trigger signal remains low. The Jet will stop dispensing once the signal returns to high. The Count entry is ignored in LEVEL mode.</p> <p>For example, if Recipe#1 has a Refill Time of 2 msec and a Dwell Time of 3 msec and the falling edge signal has remained low for 100 msec, then the Jet will dispense 50 drops ((100/ 2 + 3)). Here, the Count value is ignored.</p>
5	Go	<p>Click Go to activate a recipe manually. When the recipe is initiated, either manually or remotely by a PULSE mode trigger, the recipe will activate the exact number of times specified in Count without stopping.</p>
6	Trigger Map	<p>Displays the assignment of the trigger input to the dispensing recipes.</p> <p>For example, input trigger signal from I/O Pin 1 is used to activate Recipe #1. The BusyFlag (I/O Pin 7) is an output signal that external controller/robot can use to monitor the Jet value status. When the Jet is idle, the BusyFlag signal is set to high and set to low when the Jet is activated. External controller /robot can use the BusyFlag signal to synchronize the timing for the next Recipe trigger.</p> 
7	Download Settings	<p>Click on this button to download timing recipes, drop count, trigger mode for the six recipes, and the settings for the temperature controller. The download command will overwrite the current settings in the controller.</p>
8	Heater Options	<ul style="list-style-type: none"> • Heater On: allows you to set the heater on the controller to On or Off state. • Set temperature to: allows you to enter a value (in degrees Celsius) for the nozzle heater <p>Heater Controller in Temperature Controller (pg 3) has instructions on changing the heater settings using the front panel keys.</p>
9	Heater Off Timer	<p>Automatically turns off the heater after a specified Jet idle time. This can be accomplished by setting a time in minutes. This feature is useful if materials will be adversely affected by long periods of heating. Some material can be ‘cured’ by high temperature when sitting in the nozzle chamber for a long period of idle time. A zero timer value will not activate the Heater Off timer option.</p>

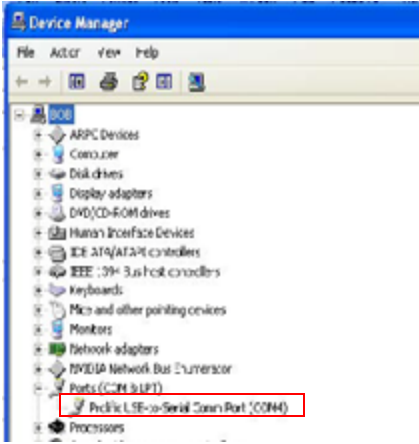
<p>10</p>	<p>RS232 Settings</p>	<p>Default settings for NCM5000 Controller Interface Software program and the controller: CTS - ON for hardware handshake Baud Rate - 57600 Parity – NONE Data Length - 8BIT</p> <p>The value for the COM Port is set by NCM5000 Controller Interface Software on program startup. The program polls each COM port in your computer and looks for the controller. NCM5000 Controller Interface Software will warn the user if it fails to find the COM port for the controller. To trouble shoot, open Device Manager (Control Panel\System\Hardware\Device Manager) to view a list of hardware devices installed on your computer and properties for each device. An entry for Ports (COM & LPT) will appear on the Device Manager list when a USB/Serial adapter cable is installed in your PC.</p> <p>For example, the list shown here has a USB-to-Serial Com Port assigned a value of 4 (COM4).</p> 
<p>11</p>	<p>Check Status</p>	<p>Checks the communication status between the NCM5000 Controller Interface Software program and the controller. A Ready status indicates communication is working. A Com Port Error or Read Error status indicates a RS232 cable connection failure.</p>

Timing Recipes Menu

Before you can start dispensing, you must first create Timing Recipes for fluids you wish to dispense using the Timing Recipes Menu. Once configured, the Timing Recipes can be downloaded into the NCM5000 Controller Interface Software controller. Once the recipes are downloaded, the controller can be triggered remotely through digital inputs from the host controller without the NCM5000 Controller Interface Software program running in the background. Several default Timing Recipes for popular fluids are provided to allow the user a quick start up.

IMPORTANT: Once the names and timing values have been chosen for a recipe, be sure to click the APPLY button to retain the changes.

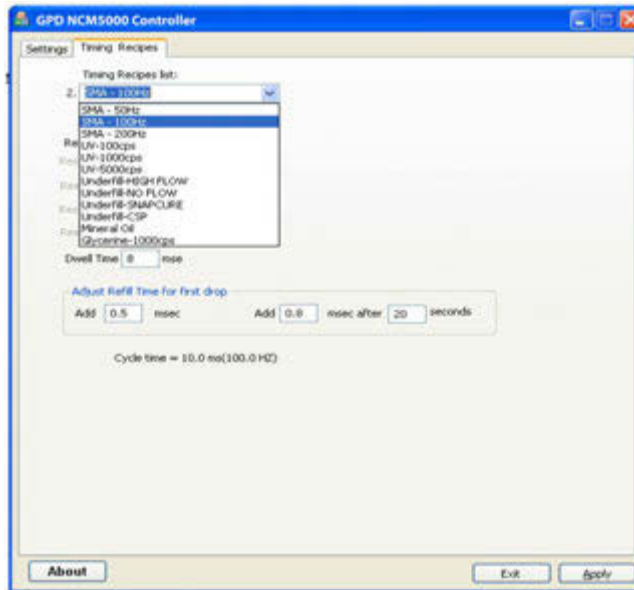

1	Timing Recipe List	Program up to 12 Timing Recipes. Each Timing Recipe should have a distinct and unique name. A good choice for a name would be a particular fluid/ material type (SMA-100Hz, UV-100cps, etc.) or part number. These names will be used to identify fluid values and are used in the recipe list in the Settings screen.
2	Refill Time	Sets the Flow time required for the material to flow into the orifice after each drop has been ejected. Time is set in msec with 0.1 msec resolution.
3	Reserved 2 to Reserved 5	These timers are not used for NCM5000. They are set to zero by default.
4	Dwell Time	Sets the time required for the material to be ejected from the orifice. Time is set in msec with 0.1 msec resolution.

5	Adjust Refill time for first drop	<p>There are two time values you can use to adjust the size and quality of the first drop.</p> <p>Add xxx msec: is a time value that is added to Refill Time. This value is added to every drop in DROP Mode described in DROP Mode Programming (pg 30). However, this value is added only to the very first drop in LINE Mode described in LINE Mode Programming (pg 30). For example, the Refill Time for all drops in DROP mode would be 2 + 0.5 = 2.5 msec. The value of Refill Time in LINE mode is 2 msec except for the very first drop which is 2.5msec.</p> <p>Note: This is the value of Refill+ displayed on the LCD screen of the NCM5000 Controller Controls (pg 3).</p> <p>Add XX msec after YY seconds: is a time value added to the Refill Time after the jet is idled for a defined number of seconds. This additional time is added only to the first drop in both DROP and LINE Mode. For example, the Refill Time for the first drop in either DROP or LINE mode after 20 seconds of idle would be 2 + 0.8 = 2.8 msec.</p> <p>Note: This is the value of Refill++ displayed on the LCD screen of the NCM5000 Controller. In general the value of Refill++ is slightly larger than Refill +.</p> <p>Note: For further description, refer to First Drop Compensation (pg 39).</p>
---	-----------------------------------	--

Programming Timing Recipes

- A Recipe specifies two timers – Refill Time and Dwell Time – which set the performance of the jet and the size and volume of the jetted drop. The values for Refill Time and Dwell Time should be chosen to optimize the performance and quality of the jet. The values depend on the rheology of the fluid to be dispensed. Refill Time is dependent on the viscosity of the fluid, temperature, and fluid-pressure. It is best to determine the Refill time through application testing. For example, for an UV adhesive with 1,000 cps, a typical refill time might be 1.7 - 2 msec at 0.103 MPa (15 psi) fluid pressure. Too short a refill time could result in a poor quality drop or a missed drop. Too long a refill time could cause accumulation of material on the nozzle tip.

NOTE: If insufficient refill time is used, the jet will be “starved” and the drop size could be inconsistent. A pattern of large and small drops is usually a sign that the jet needs more time to refill. If this pattern is observed, increase the value of Refill Time until the drops are consistent and stable. Alternatively, you can increase the fluid pressure instead of the refill time if a specific drop rate is desired.

- The two values, **Add XX msec** and **Add XX msec after YY seconds** ([First Drop Compensation](#) (pg 39)) can be added to the Refill Time to adjust the time for the first drop in either the DROP mode or LINE Mode. This is useful with materials that are “shear thinning” and need a little extra time initially after being idle for a period of time. The extra refill time gives the jet a little extra time for the first drop to be ejected.
- The Dwell Time controls the time for the material to flow out the nozzle orifice and form a drop. In DROP mode ([DROP Mode Programming](#) (pg 30)), the value of Dwell Time is usually not important since its duration is small compared to the motion time of the robot moving from one position to the next. In LINE mode ([LINE Mode Programming](#) (pg 30)), however, the Dwell Time is important and sets the drop cycle time. The following formula gives the relationship of drop cycle time, drop spacing, and robot velocity.

$$\Delta T \text{ (Drop cycle time)} = \text{Refill Time} + \text{Dwell Time}$$

$$\Delta X = \text{Desired Drop Spacing}$$

$V =$ (Robot Velocity)

$V = \Delta X / \Delta T = \Delta X / (\text{Fill Time} + \text{Dwell Time})$

- The Count is the number of jetted drops desired. The drops are repeated sequentially when it receives a trigger from the robot.

DROP Mode Programming

It is very simple to program the NCM5000 system to dispense a drop at a time. The following example illustrates the programming procedure.

1. On the Settings Menu ([Settings Menu](#) (pg 25)), select the pull down menu to set the timing recipe for "Recipe #1".
2. Set the Count entry to 1 for "Recipe #1"
3. Set the Trigger Mode for "Recipe #1" to PULSE.
4. Click on "Download Settings" to send the new options to the controller.
5. The Robot moves to an XY position.
6. The Robot sends a trigger signal on I/O Pin 1 to the Jet Controller to jet a drop.
7. The Robot moves to another XY position.
8. The Robot sends a trigger to the Jet Controller to jet a drop, and so on.

The following example illustrates how to dispense multiple drop sizes.

1. On the Settings Menu, select the pull down menu to set the timing recipe for "Recipe #1" and "Recipe #2".
2. Set the Count entry in "Recipe #1" to 1 for one drop.
3. Set the Count entry in "Recipe #2" to 2 for two drops.
4. Set the Trigger Mode for "Recipe #1" and "Recipe #2" to PULSE.
5. Click on "Download Settings" to send the new options to the controller.
6. The Robot moves to an XY position.
7. The Robot sends trigger signal on IO Pin 1 to jet one drop.
8. The Robot then moves to another XY position.
9. The Robot sends one trigger signal to IO Pin 2 to fire 2 drops. (Alternately, the Robot can issue multiple triggers to IO Pin 1 to fire multiple drops.)

As you can see, the programming of the NCM5000 system is very simple and flexible.

LINE Mode Programming

The NCM5000 Controller has a built-in LINE mode to make dispensing lines very simple. The following example illustrates how this can be done.

1. Set the Refill Time to 2 msec, and Dwell Time to 3 msec in the Timing Recipes menu ([Timing Recipes Menu](#) (pg 28)) for the material you wish to use. (The timing is given here for illustration purposes – the exact timing for your fluid and pressure may be different). The ΔT for this example is 5 msec/drop or 100 drops/sec.

2. If you want to dispense 60 drops in the LINE, go to the Settings menu ([Settings Menu](#) (pg 25)) and select the 5 msec recipe in the pull down menu, set the Count entry in to 60 and the Trigger Mode to PULSE in "Recipe #3".
3. Click on Download Settings to send the new settings to the controller.
4. If your drop spacing ΔX is 0.5 mm, set the velocity of the robot to $V = \Delta X / \Delta T = 0.5\text{mm} / 0.005\text{sec/drop}$ results in a robot velocity of 100 mm/sec since.
5. The Robot makes an XY move at 100 mm/s and issues a trigger to IO Pin 3. The NCM5000 controller will jet 60 drops at 0.5mm spacing.
6. If you want smaller drops while maintaining the same velocity and ΔX , you can change the Refill Time to 1.7 msec and Dwell Time to 3.3 msec to keep ΔT to be at 5 msec.

Another method to dispense a line is to set the Trigger mode to LEVEL. The following example illustrates how this can be done.

There is also another method to dispense a line if the Robot has the capability to issue triggers during an XY move. The robot will make an XY move and send pulses of trigger to the NCM5000 controller at the position where it wants to jet a drop. The following example illustrates the procedure.

1. Set the Refill Time to 2 msec, Dwell Time to 2.8 msec, and the number of drops to "1".
2. The robot makes an XY move.
3. The robot sends a trigger to the NCM5000 Controller every 5 msec to form a string of drops.

CAUTION: It is important to not issue a new pulse to the NCM5000 until the ΔT cycle is completed; otherwise, the NCM5000 Controller will ignore the trigger if it has not completed its cycle. In the above example, we set the Dwell Time to 2.8 msec to ensure the NCM5000 cycle is completed before the robot issues a new pulse.

Running a Program from Software

Before running a program for the first time, make sure to check the following:

- Connect all electrical cables to the NCM5000. This includes the jet cable, the I/O cable if remote triggering is used, the RS-232 cable when running from the computer, and the power cable. All connects are unique.
- Turn ON the NCM5000 Controller. The heater controller and LCD display should indicate the system is active.
- Run the NCM5000 Controller Interface Software and make sure the main screen is active, the Controller Status shows: Ready and the Jet button is RED.

NOTE: When loading the NCM5000 Controller Interface Software, an initial screen will prompt you that any previous values set manually in the controller will be reset. Be sure to note down the values in the controller front panel LCD screen if you want to chose Yes to overwrite the settings.



NOTE: If this is your first time running the NCM5000, do not attempt to use the remote triggering. Run the jet from the main NCM5000 Controller Interface Software screen.

- In the Settings menu, select the default recipe, **SMA 50 – 50Hz**, in the **Recipe #1**. The default timing is (2,8) (0.5, 0.8, 20), the Count is set to 1, and the Trigger Mode is set to Pulse.
- Park the NCM5000 Jet over a cup and push the **Jet** button on the main screen. The Button should turn from RED to BLUE. You should see the material flow through the Feed Tube and out the tip. It might take a while if the material is thick. If the material does not flow out the tip, heat is probably needed. A good starting temperature is 45° C. Refer to [Application Hints](#) (pg 13).
- Once material flows, you have successfully primed the jet and are ready to jet actual drops of your material.

Commands

The NCM5000 Controller Commands (NCC) is a simple set of commands for controlling the Jet and timing values and settings for the recipes. A host computer or external robot is connected to the NCM5000 Controller via an RS-232 cable. The host/robot sends NCC commands, in ASCII format, to the controller. This section is intended to serve as a reference for one who is writing a custom program to control the NCM5000 Controller via NCC commands.

The RS-23 Interface

The NCM5000 Controller is connected to the host computer/external robot via an RS-232 cable. The default settings for the controller are CTS ON, 57600 for Baud Rate, Parity is NONE and Data Length is set to 8BIT. If the host wants to change the default RS-232 settings, refer to [Settings Menu](#) (pg 25) for details.

Command Format

Each command is identified by two ASCII characters (ST, SL, CT,...) and followed by a series of values. Each value is separated by a COMMA and the last value must be terminated by a SEMICOLON.

- **ST** Set Recipe Timers
- **SL** Adjust Refill Time for First Drop
- **CT** Set Drop Count and Trigger Format
- **SM** Select Recipe
- **SG** Start Dispensing
- **SV** Set Jet Value State
- **SH** Set Heater Temperature
- **SO** Turn Heater On/Off
- **HF** Heater Off timer
- **OS** Output Jet Status
- **OT** Output Temperature
- **OV** Output Version

Example: CT 0,0,2; is a valid command. But, CT 0,0,2 is not valid because the controller is looking for a semicolon before executing this command.

Recipe Timing Commands

ST # RecipeID, # Refill, #0, #0, #0, #0, #Dwell; (Set Recipe Timers)

The **ST** function configures the timing values for the recipe. There are 7 parameters required for this function:

#RecipeID 0	→ Recipe #1
#RecipeID 1	→ Recipe #2
#RecipeID 2	→ Recipe #3
#RecipeID 3	→ Recipe #4
#RecipeID 4	→ Recipe #5
#RecipeID 5	→ Recipe #6

#RecipeID	Identifies the recipe and it must be between 0 and 5 .
#Refill	Specifies the Refill Time in 0.1 msec units.
#0, #0, #0, #0	Four reserved timer values and they must all be zeros.
#Dwell	Specifies the Dwell Time in 0.1 msec units.

Example 1: The **ST 0,18,0,0,0,0,32**; command will set the first recipe, Recipe #1 to 1.8 msec for Refill Time and 3.2 msec for Dwell Time. The Refill Time plus the Dwell Time set the single drop cycle time to 5msec (1.8 +3.2) resulting in a drop frequency of 200 drops per second.

Example 2: The **ST 3,50,0,0,0,0,150**; command will set Recipe #4 to 5 msec for Refill Time and 15 msec for Dwell Time. The Refill Time plus the Dwell Time set the single drop cycle time to 20msec (5+15) resulting in a drop frequency of 50 drops per second.

SL # nRecipeID,# Refill+,# Refill++,# DelaySec; (Adjust Refill Time for First Dot)

The **SL** command adjusts the Refill Time for the first dot. These values help to control the size and quality of the first dot. There are 4 parameters for this function:

#nRecipeID	Identifies the recipe and it must be between 0 and 5 .
#Refill+	Sets the timing value in 0.1 msec units to be added to the first dot.
#Refill++	Sets the timing value in 0.1 msec units to be added to the first dot after the Jet is idle for #DelaySec seconds.
#DelaySec	Sets the Jet idle time used by the #Refill++ in seconds.

Example: The **SL 0,2,4,20**; command will set the first recipe, Recipe #1 to 0.2 msec for Refill+ Time , 0.4 msec for Refill++ Time and 20 seconds for idle time. The Refill+ Time (0.2 msec) is added to the Refill Time of Recipe #1 for every drop in DROP mode and added only to the very first drop in LINE mode described in section 13.6. If the Jet has been idle for more than 20 seconds, then the Refill++ Time (0.4 msec) is used for first drop adjustment.

CT #nRecipeID,#TriggerFormat ,#nDotCount; (Set Dot count and Trigger Format)

The **CT** command sets the count value for drops and the format for the trigger input. There are 3 parameters for this function:

#nRecipeID	Identifies the recipe and it must be between 0 and 5 .
#TriggerFormat	Sets #TriggerFormat to 0 for PULSE and 1 for LEVEL.
#nDotCount	Sets the number of drops per trigger signal.

Example 1: The **CT 0,0,2;** command will set the first recipe, Recipe #1 to PULSE trigger and a drop count of 2. This command will cause the Jet to dispense 2 drops when it receives a PULSE signal from Recipe #1 Trigger.

Example 2: The **CT 1,1,5;** command will set the second recipe, Recipe #2 to LEVEL trigger. The number of drops will depend on the duration of the LEVEL signal (low) from Recipe #1 Trigger and the single drop cycle time defined by the **ST** command. The drop count value of 5 is ignored.

Jetting Commands

SM # nRecipeID; (Select Recipe)

The **SM** command identifies the recipe that the controller should use when it receives a **SG** (start dispensing) command from the host/robot. This command should be sent before an **SG** command to identify the recipe timers and settings.

#nRecipeID	Identifies the recipe and it must be between 0 and 5 .
------------	---

Example: The SM 3; command selects Recipe #4

SG (no values required); (Start Dispensing)

The **SG;** command will cause the controller to activate the Jet. You need to use the SM command to identify the recipe for timing values and the number of drops to dispense. The SG command must be followed by a semicolon.

Example: Here is a sequence of commands sent to the controller to program Recipe#1 and Recipe#2 before dispensing:

```

ST 0,50,0,0,0,0,100;
SL 0,2,4,20;
CT 0,0,1;
ST 1,50,0,0,0,0,150;
SL 1,2,4,20;
CT 1,0,2;

```

The **CT** command sets one drop to dispense for Recipe#1 and two drops for Recipe#2. When the external host moves to an XY position, it might send the following commands to dispense one drop using the values setup in Recipe#1:

SM 0;

SG;

The host then moves to another XY position and sends another **SG;** command to dispense another drop at the new location. It can keep on doing this as long as it is using the values in Recipe#0. If the host decides to dispense 2 drops at the new location, it should send SM 1; command to select Recipe#1 before issuing a **SG;** command.

SV # nValveID,# nValveStatus; (Set Jet Valve State)

This command allows the host to open or close the Jet valve.

#nValveID	Set to 0 for Jet valve.
#nValveID Status	Set to 0 to open the Jet valve and 1 to close.

Example: The command **SV 0,1;** will close the Jet.

Heater Commands

SH # nTemperature; (Set Heater Temperature)

The **SH** command allows the host to set the temperature for the Heater Controller in the NCM5000 Controller. This value should be less than 75 degrees Celsius.

#nTemperature	The temperature value is in degrees Celsius.
---------------	--

SO # nFlag; (Turn heater On/Off)

The **SO** command allows the host to turn On or Off the heater in the controller.

#Flag	Set to 1 to turn On the heater. Set to 0 to turn the heater Off.
-------	--

HF # nMins; (Heater Off Timer)

The **HF** command gives the host the ability to automatically turn Off the heater after a specified Jet idle time.

#nMins	Defines the idle Jet time in minutes.
--------	---------------------------------------

Example: The following commands will set the heater temperature to 50 degree Celsius, the idle time to 5 minutes and turn On the heater.

SH 50;

HF 5;

SO 1;

Output Commands

OEOutput Error

The host can send the OE; command to verify that it is communicating properly with the controller. A return string of 0; indicates that the command was received without error and 0; indicates there was an error in the previous command. Once the OS command return string is returned, the error state in the controller is cleared.

OSOutput Jet Status

The host can send the OS; command to verify that it is communicating properly with the controller. A return string of 1; indicates that the Jet valve is closed and 0; indicates the valve is opened.

OTOutput Temperature

The host can send this OT; command to get the present temperature of the Jet heater. A return string of 50.5; indicates temperature is 50.5 degree Celsius.

OVOutput Version

The host can send this OV; command to identify the controller. A return string indicates that the host has found the controller.

NOTE: The controller might not be able to respond to output commands when it is busy dispensing a long series of drops. In this case, the host should try again after a short wait.

Troubleshooting

Table 1:

Symptom	Problem	Action
LCD display shows meaningless or random characters.	The cable for the LCD display or the display is not functioning properly.	Replace the LCD cable. This action resolves most LCD display issues.
LCD display does not respond.		<ol style="list-style-type: none"> 1. If replacing the cable does not resolve the issue, replace the LCD display. 2. If meaningless or random characters show on the screen, perform the following "hard reset" steps: <ol style="list-style-type: none"> 2a. Turn off the controller. 2b. Press and hold the keypad (right) button for at least 10 seconds (until audible click sounds from the pump) while turning on controller power. 2c. Reprogram all Recipe values. Set the Heater (HTR) Timer to 0 instead of 10. 2d. Adjust the brightness setting for the LCD display using the LCD contrast adjustment trim-pot on the rear panel.

Appendices

- [First Drop Compensation](#) (pg 39)
- [Temperature Controller Security](#) (pg 42)
- [Temperature Controller Settings](#) (pg 43)
- [Digital Pressure Gauge](#) (pg 47)

First Drop Compensation

Background

Many viscous fluids are thixotropic and the viscosity decreases with motion. This is often referred to as shear-thinning. When dispensing a thixotropic fluid, the very first drop ejected can often be smaller than subsequent drops if the jet has been idle for some time. The parameters Refill + Refill ++ can be used to compensate for small first drops.

Traditional Solutions

Traditionally, operators often dispense a few “wasted drops” in a blank area of the substrate to get the dispensing material into a shear-thinning condition. This technique is a good solution because it gets rid of the first drop problem all together. However, it wastes time and fluid.

Compensations

The NCM5000 Controller offers two additional jetting parameters to help alleviate this problem:

- First Drop Compensation T+
- Extended Drop Compensation T++

Elapse Time

The idle time of the jet since the last dispense.

Extended Time

The time entered in the Recipes Menu/ Adjust Refill Time for first drop “msec after YY seconds”

If Elapse Time < Extended Timeout, then Refill Time = Refill + T+

If Elapse Time > Extended Timeout, then Refill Time = Refill + T++

Example: For a time cure material, the fluid could be slightly thickening if it sits idle for a long time, especially if the fluid is being actively heated. If you set the Extended Timeout to 20 seconds, the first drop refill time will equal (Refill + T*). The value of T* depends on how long the jet has been idle.

If Elapse Time < 20 sec (Extended Timeout), then T* = T+

If Elapse Time >= 20 sec (Extended Timeout), then T* = T++

The Refill Time for the first drop of all the lines = Refill + T++. Subsequent drops will have a Refill Time without any compensation if multiple drops are specified. When dispensing

individual drops with an elapsed time less than 20 seconds, the compensation is always applied. The Refill Time for individual drops = Refill + T+.

PULSE mode

In this mode, the controller produces “n” drops when it receives a trigger signal, where “n” is the number of drops.

- The refill time for the first dot = Refill + T +
- The refill time for all subsequent dots = Refill (no added first drop compensation)
- If the number of drops is set to 1, the refill time will always be Refill + T + because there is no subsequent dots.

Example of when number of drops is 1:

- In the timing diagram below, $T^*=T++$, therefore each drop = Refill + T++

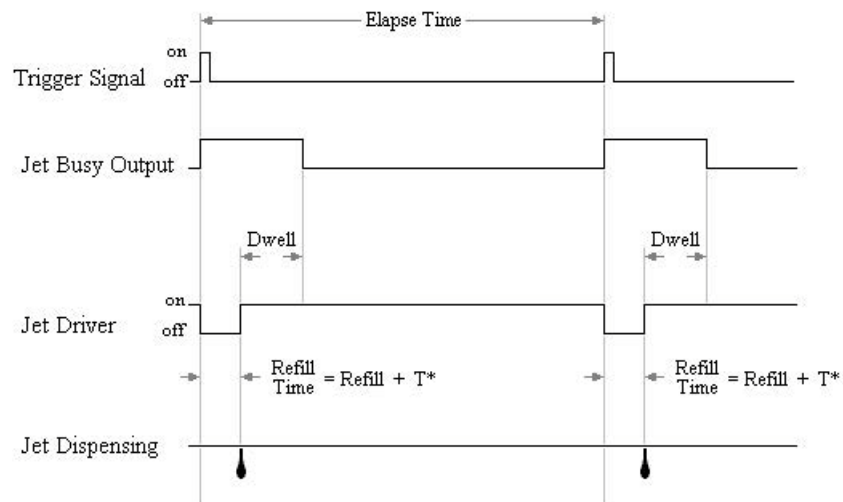

Example of when number of drops is 3:

- In the timing diagram below, $T^* = T +$, therefore the first drop = Refill + $T +$
- The refill time for all other drops = Refill (no first drop compensations added)

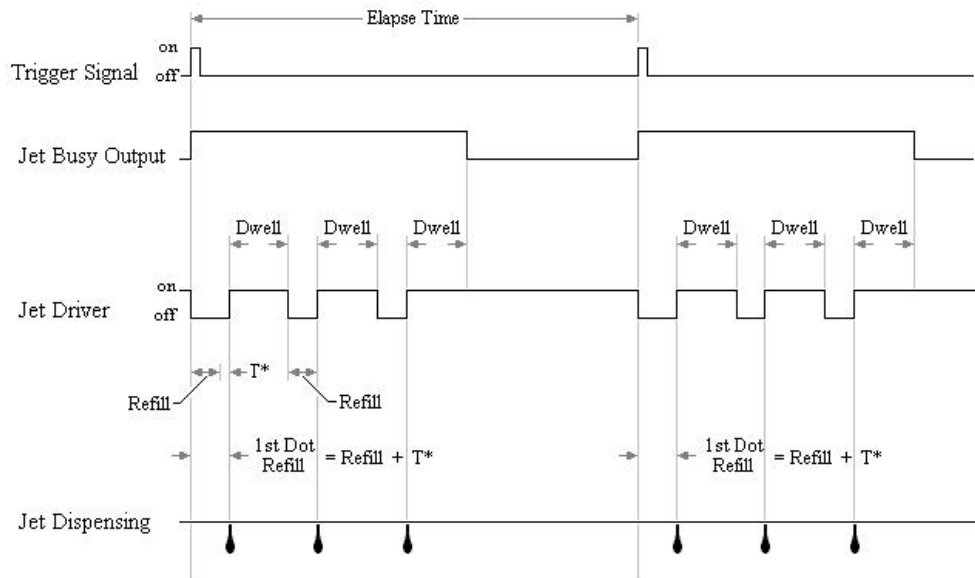

LEVEL mode

In this mode, the controller produces drops as long as the Trigger signal is high.

- The refill time for the first dot = Refill + $T +$
- The refill time for all subsequent dots = Refill

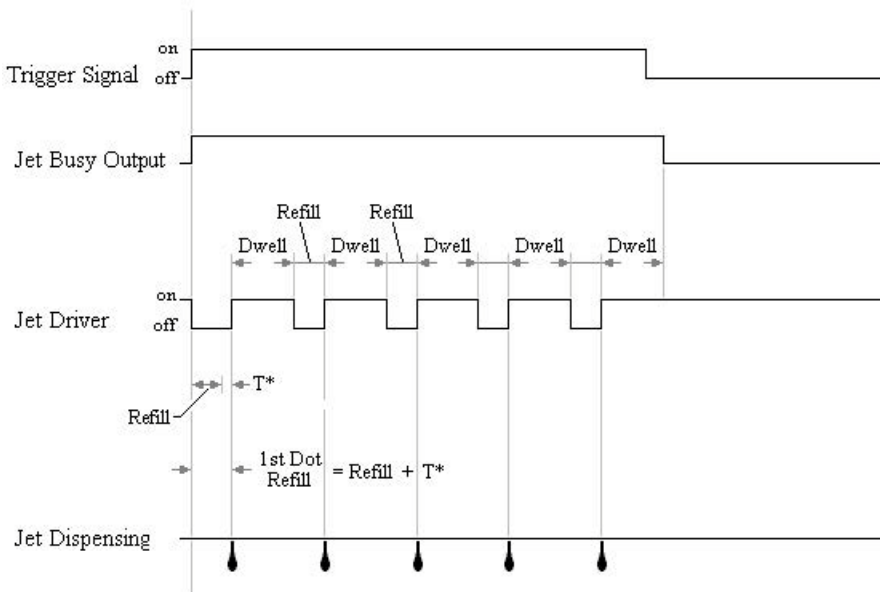

Temperature Controller Security

Love Controls Security

Two security lock settings are available to prevent unauthorized personnel from changing parameter settings.

Security parameters are set in **Operation Mode**.

Secure all parameters

The LoC1 setting affects all parameters in the controller. If LoC1 settings is enabled, the operator must unlock the controller to make any changes to controller parameters.

To unlock control, the operator must depress the ENTER and INDEX keys simultaneously.

Secure all parameters except set point

The LoC2 setting affects all parameters except the set point. If LoC2 settings is enabled, the operator will only be able to change the set point.

In order to change any of the other parameters, the operator must unlock the controller before making any changes.

To unlock control, the operator must depress the ENTER and INDEX keys simultaneously.

Temperature Controller Settings

- [Love Controls Settings](#) (pg 43)
- [Omega Settings](#) (pg 44)
- [Watlow Settings](#) (pg 45)

Love Controls Settings

The factory-set values should work for the majority of applications.

CAUTION: It is strongly recommended that you do not modify these values as they are programmed to work with the controller and the Jet nozzle plate.

Communication Parameters List

Controller offers a RS-485 port for serial communication.

Address	Content	Explanation
4700H (R)	Process value (PV)	Measuring unit is 0.1, updated one time in 0.5 second.
4701H	Set point (SV)	Unit is 0.1, °C or °F
4702H	Upper-limit alarm 1	
4703H	Lower-limit alarm 1	
4704H	Upper-limit alarm 2	
4705H	Lower-limit alarm 2	
4706H	Upper-limit of temperature range	The data content should not be higher than the temperature range
4707H	Lower-limit of temperature range	The data content should not be lower than the temperature range
4708H	PB Proportional band	0.1 to 999.9, unit is 0.1
4709H	Ti Integral time	0 to 9999
470AH	Td Derivative time	0 to 9999
470BH	Heating/Cooling hysteresis	0 to 9999
470CH - 470FH		Reserved
4710H	Input temperature sensor type	Please refer to the contents of the "Temperature Sensor Type and Temperature Range" for detail
4711H	Control method	0: PID (default), 1: ON/OFF, 2: manual tuning
4712H	Heating/Cooling control cycle	1 to 99 second
4713H	Proportional control offset error value	0% to 100%
4714H	Temperature regulation value	-999 - 999, unit: 0.1
4715H	Alarm 1 type	Please refer to the contents of the "Alarm Outputs" for detail
4716H	Alarm 2 type	Please refer to the contents of the "Alarm Outputs" for detail
4717H	Temperature unit display selection	°C: 1 (default), °F: 0
4718H	Heating/Cooling control Selection	Heating: 0 (default), Cooling: 1
4719H	Control Run/Stop setting	Run: 1 (default), Stop: 0
471AH	Communication write-in selection	Communication write in disabled: 0 (default), Communication write in enabled: 1
471BH	Software version	W1.00 indicates 0 x 100
4729H	AT Setting	OFF: 0 (default), ON:1
472BH (R)	Code 0	Normal operation (No error)
	Code 1	Initial process
	Code 2	Initial status (Temperature is not stable)
	Code 3	Temperature sensor is not connected
	Code 4	Temperature sensor input error
	Code 5	Measured temperature value exceeds the temperature range
	Code 6	No Int. error
Code 7	EEPROM Error	
4733H	CT monitor value	Unit is 0.1A

Note: R means "read only" value

Omega Settings

The default factory-set values should work for the majority of applications. It is strongly recommended that you do not modify these values as they are programmed to work with the controller and the Jet nozzle plate.

Modes of Operation

- **Operation:** To enter operation mode – press the cycle key once (second key from left).
- **Regulation:** To enter regulation mode – press the enter key (the key furthest to the left).
- **Initial Settings:** To enter initial setting mode – press enter key for more than 3 seconds.

ADDRESS		DEFAULT VALUES		
Operation Mode				
4719H	Control Run/Stop setting		r-5	
4702H	Upper-Limit alarm 1	0	AL1H	set ALA1 to 1
4703H	Lower-Limit alarm 1	0	AL1L	set ALA1 to 1
		oFF	LOC	*****
Regulation Mode				
4709H	PB Proportional band (0.1 unit)	4	P	
470AH	Ti Integral time	20	i	
	Td Derivative time	5	d	
4712H	Default value of Integral Volume	0	ioF	
4714H	Heating Control Cycle Setting	10	HtPd	
	Process Temperature Offset	0	tPoF	
Initial Settings				
4717H	Input temp sensor type	14 (Pt2)	inPT	Pt100 type2
4706H	Temp Unit Display	C	tPUn	
4707H	Upper Limit of temp range (default 500)	75	tP-H	
4711H	Lower Limit of temp range	-20	tP-L	
4718H	Control Method	0 (PID)	Ctrl	
4715H	Heating/Cooling control	0 (Heat)	S-HC	
4716H	Alarm 1 type	0	ALA1	
	Alarm 2 type	0	ALA2	
471AH		ASCII	C-5L	*****
	Communication write-in selection	1 (ON)	Co5H	*****
	Controller address	1	C-no	*****
	Baud Rate Setting	9600	bP5	*****
	Communication Data Length	8	Len	*****
	Communication Parity Bit	nonE	Prty	*****
	Communication Stop Bit	1	Stop	*****

Watlow Settings





To recover settings:

Several layers of settings have probably been set up and saved to fully customize the Watlow temperature controller for your application. If these settings have been changed inadvertently, you have two recovery options:

- [Retrieve Factory Settings](#) (pg 45)
- [Reestablish Factory Settings](#) (pg 45) if a more radical recovery is required.

Retrieve Factory Settings

To reset the temperature controller settings back to the factory values, input the following values:





1. Press the UP and DOWN keys for 6 seconds until the display reads: 
2. Press the UP key until the display reads: 
3. Press the ADVANCE key until the display reads: 
4. Press the UP key until the display reads: 
5. Press the ADVANCE key until the display reads: 
6. Press the INFINITY key 2 times to save values.

Reestablish Factory Settings

Reestablishing settings for the temperature controller back to factory values requires setting Watlow factory values, setting GPD factory values, and saving all factory settings to Set 1:





I. Set Watlow Factory Settings

To reestablish Watlow factory settings:

1. Press the UP and DOWN keys for 6 seconds until the display reads: 
2. Press the UP key until the display reads: 
3. Press the ADVANCE key until the display reads: 
4. Press the DOWN key until the display reads: 
5. Press the ADVANCE key until the display reads: 
6. Press the INFINITY key 2 times to save values.

II. Set GPD Factory Settings & Save All Factory Settings

To reestablish GPD factory settings and save both Watlow and GPD factory settings to Set1:

1. Press the UP and DOWN keys for 6 seconds until the display reads: 
2. Press the UP key until the display reads: 
3. Press the ADVANCE key until the display reads: 
4. Press the UP key until the display reads: 
5. Press the ADVANCE key until the display reads: 
6. Press the INFINITY key 2 times to save values.

Digital Pressure Gauge

Keyence Two-color Digital Display Pressure Sensor, AP-30 Series



SPECIFICATIONS

Type	Negative pressure	Positive pressure		Compound pressure
Model ¹	AP-31(Z)	AP-32(Z)	AP-33(Z)	AP-34(Z)
Rated pressure	0 to -101.3 kPa (0 to -760 mmHg)	0 to 100.0 kPa (0 to 1 kgf/cm ²)	0 to 1.000 MPa (0 to 10 kgf/cm ²)	+101.3 to -101.3 kPa (+760 mmHg to -760 mmHg)
Proof pressure	490 kPa (5 kgf/cm ²)	490 kPa (5 kgf/cm ²)	1.47 MPa (15 kgf/cm ²)	490 kPa (5 kgf/cm ²)
Pressure type	Gauge pressure			
Fluid types	Air or noncorrosive gases			
Display	3 1/2-digit, 2-color, 7-segment LED (Character height: 11 mm)			
Display resolution	0.1 kPa, 1 mmHg, 0.02 Psi	0.1 kPa, 0.001kgf/cm ² , 0.02 Psi	0.001 Mpa, 0.01kgf/cm ² , 0.2 Psi	0.2 kPa, 2 mmHg, 0.04 Psi
Detectable pressure range	-15% to +110% of F.S.			
Repeatability	±0.2% of F.S. (5 ms or more)			
Response time (chattering prevention function)	2.5/5/100/500 ms (selectable)			
Zero-shift input ²	Non-voltage input (contact, solid-state), Input time: 20 ms or more			
Control output	NPN open-collector: 100 mA max. (40 V max.), Residual voltage: 1 V max. 2-output (N.O./N.C. selectable)			
Analog output ³	1 to 5 V (Load impedance: 47 kΩ min.)			
Temperature fluctuation for analog output	±2% max. (of F.S.) of detecting pressure at 25°C (0 to 50°C)			
Temperature fluctuation for display	±1% max. (of F.S.) of detecting pressure at 25°C (0 to 50°C)			
Current consumption	50 mA (at 24 V), 90 mA (at 12 V)			
Power supply	12 to 24 VDC±10%, Ripple (p-p): 10% max.			
Ambient temperature	0 to 50°C			
Relative humidity	35 to 85%			
Vibration	10 to 55 Hz, 1.5 mm double amplitude in X, Y, and Z directions, 2 hours respectively			
Material	Front housing: Polyamide, Front panel sheet: PET, Rear housing: Polysulfone, Pressure port: Die-cast zinc, Cable: Oil-proof cabtyre cable			
Weight (including 2 m cable)	Approx. 120 g			

1. The zero-shift type sensor is suffixed with Z after the model name.

2. Z type only. 3. Not provided with Z type

PART NAMES AND FUNCTIONS

AUTO key
In auto-tuning mode, use this key to detect pressure. In measurement mode, press this key for 2 seconds or more to adjust the zero-point.

SET key
Use this key to display or change preset values.

Output indicator 1 (Red LED)

Output indicator 2 (Green LED)

Display unit label

UP/DOWN key
Use these keys to set output modes, or to change preset values or units.

Housing

Hexagonal socket bolt

Rear metal casing (Die-cast zinc)

■ Display unit label
The AP-30 series enables you to select the display units for pressure. Attach the included display unit label for the desired units at the position in the figure.

CONNECTIONS AND INPUT/OUTPUT CIRCUIT

■ Connections

- Drive current load
- Input to voltage input equipment

■ Input/output circuit

- Output circuit

AP-31Z/32Z/33Z/34Z (Z type only)

Input circuit (Zero-shift input)
Zero-shift input resets the display to "0" at the rising edge of the signal.

AP-31/32/33/34 (Except for Z type)

Analog output circuit

OPERATION MODE SELECTION

■ Auto-tuning mode (F-1)

Using the AUTO key, detect the upper limit value (A) and the lower limit value (b). The detection level (C) is automatically set at the midpoint between the two values. (You can finely adjust the preset value C within the range between A and b.)

Control output 1: The sensor turns on when the pressure exceeds the preset value C.

Control output 2: The sensor turns on when the pressure goes outside the stability levels.

* The stability levels are automatically set as shown in the following calculations.

$$SH = \frac{(A + C)}{2}$$

$$SL = \frac{(C + b)}{2}$$

■ Hysteresis mode (F-2)

Set desired detection level (H) and hysteresis (h) for the detection.

Control output 1: The sensor turns on when the pressure exceeds the preset value H. When the pressure falls by the preset value h, the sensor turns off.

Control output 2: The sensor turns on when the pressure goes outside the hysteresis width (H - h).

h: Hysteresis width of OUT1

* When h is set to a value close to 0, if pressure fluctuates around the detection point, OUT1 will chatter.

■ 2 independent mode (F-3)

Set two desired detection points (A and B).

Control output 1: The sensor turns on when the pressure exceeds the preset value A.

Control output 2: The sensor turns on when the pressure exceeds the preset value b.

■ Window mode (F-4)

Set desired upper limit value (H) and lower limit value (L).

Control output 1: The sensor turns off when the pressure goes outside of the range between the upper limit value (H) and lower limit value (L).

Control output 2: The sensor turns off when the pressure goes outside of the stability levels.

* The stability levels are automatically set as shown in the following calculations.

$$SH = H - \frac{(H - L)}{4}$$

$$SL = L + \frac{(H - L)}{4}$$

Note 1: The above description shows the operation of control outputs 1 and 2 when the output selector switch is set to N.O. When the output selector switch is set to N.C., the operation of control outputs 1 and 2 is inverted.

Note 2: Except for OUT1 in hysteresis mode, each control output includes an internal hysteresis of 0.5% of F.S.

OTHER FUNCTIONS AND ERROR INDICATION

■ Zero-shift function (Z type only)

The zero-shift function is used to reset the current pressure value to "0" using an external signal input, in order to prevent measurements from being affected by fluctuations in base pressure.

Example: Leakage test

Input a zero-shift value after air supply is completed so that air leakage after a specified time is displayed as a negative value. The AP-30's detection is unaffected by fluctuations in air supply volume.

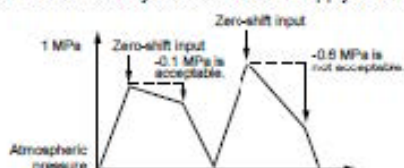

When the power is turned off, the value updated after the zero-shift input (zero-shift value) is lost.

Note 1: The zero-shift function cannot be used in auto-tuning mode.

Note 2: The zero-shift input is effective when the current pressure is between -3% of F.S. and F.S. for a shift of 0 (P = 0).

Note 3: If the applied pressure is outside the range of -15% to 110% of the rated pressure, "-FFF" or "FFF" appears.

■ Key protection function

The key protection function is used to lock the front panel key in order to prevent preset values from being accidentally changed.

To enable the key protection function, hold down [A] and press [A].

"Loc" flashes for 2 seconds and the keys are locked.

To disable the key protection function, again hold down [A] and press [A].

"UnL" flashes for 2 seconds and the keys are unlocked.

Using the EEPROM, the AP-30 series can retain the preset values even if the power is turned off.

■ Display color selection

You can set the color of the LED display either to the two color mode which displays the numerical value in green or red according to OUT1, or to the single color mode which always shows the value in red. The two-color display allows you to check the output condition at a glance. (Refer to "ADJUSTMENT" on page 3 for the setting procedure.)

In two-color mode (Regardless of N.O./N.C. selection)

- When OUT1 is turned on: Red
- When OUT1 is turned off: Green

■ Peak-hold/bottom-hold display function

The AP-30 series internally updates the peak-hold and bottom-hold values at all times.

● To display hold values

- While [A] is held down in measurement mode, the peak-hold value is displayed.
- While [B] is held down in measurement mode, the bottom-hold value is displayed.

● To reset the peak-hold and bottom-hold values

- Hold down [A] and press [B] in measurement mode.

● The peak-hold and bottom-hold values are also reset using the following procedure.

- Turn the power off.
- Press [A] for 3 seconds or more and change any settings.

Note: The hold values cannot be displayed when the front panel keys are locked with the key protection function. Disable the function before displaying the hold values.

■ Analog output function (Except for Z type)

The voltage value according to the pressure value is output.

Model	1 V to 5 V
AP-31	0 to -101.3 kPa
AP-32	0 to +100.0 kPa
AP-33	0 to +1.000 MPa
AP-34	+101.3 to -101.3 kPa

■ Error indications and remedies

Error Indication	Problem	Remedy
E	Zero-point adjustment was executed at a pressure of ±5% or more of F.S.	Perform zero-point adjustment at normal atmospheric pressure.
E _C	Overcurrent through OUT1 or 2	Turn power off and adjust the load so that the current is within the rated range.
-FFF, FFF	Applied pressure was outside of the display range.	Adjust the pressure to within the rated range.

■ N.O./N.C. selection

The N.O. or N.C. output can be selected according to the device's control method. When the output status is changed, the color of the numerical value display LED is inverted.

■ Chattering prevention function

The chattering prevention function is used to prevent outputs from chattering by changing the response time. The response time can be selected from 4 settings. When the detection (non-detection) state continues for more than a preset response time, the output is produced.